

City of Los Angeles Supplemental Street Design Guide



Los Angeles Supplemental Street Design Guide

TABLE OF CONTENTS

Table of Contents	1
i. Purpose of this Supplement.....	6
ii. Typical Organization of Guidance within the Supplement	6
iii. Agency Roles and Responsibilities	7
iv. Maintenance Agreements	8
v. Design Exception.....	8
1 Corner Radius.....	10
1.1 Overview	10
1.2 Definitions.....	10
1.3 General Benefits and Design Considerations.....	12
1.3.1 Benefits	12
1.3.2 Design Considerations.....	12
1.4 Applications.....	13
1.5 Identifying Street Type (Functional Class & Enhancement)	13
1.6 Design Vehicle	14
1.6.1 Default Design Vehicle	14
1.6.2 Selecting an Alternative Design Vehicle.....	17
1.6.3 Minimum Turning Radii of Vehicles	17
1.6.4 Control Vehicle.....	17
1.6.5 Turning Vehicle Design Speed.....	18
1.7 Relationship Between Effective and Actual Radius	18
1.7.1 Intersection Skew.....	18
1.7.2 Determining the Actual Radius by Evaluating the Effective Radius.....	21
1.8 Encroachment Policy.....	25
2 Curb Extension	28
2.1 Overview	28

2.2	Definitions.....	28
2.3	General Benefits and Design Considerations.....	29
2.3.1	Benefits	29
2.3.2	Design Considerations.....	29
2.4	Applications.....	29
2.5	General Design Guidance.....	32
2.5.1	Geometry	32
2.5.2	Plantings, Street Furniture and Other Utilities	32
2.6	Attached Curb Extensions (Type I) Design Guidance	33
2.6.1	Unique Benefits and Design Considerations.....	33
2.6.2	Drainage and Grading	33
2.6.3	Alternative Design Options	34
2.6.4	Accessibility Considerations.....	35
2.6.5	Maintenance Considerations	35
2.7	Floating Curb Extension (Type II)	36
2.7.1	Unique Benefits and Design Considerations.....	36
2.7.2	Alternative Design Options	36
2.7.3	Signalized Intersection Considerations	38
2.7.4	Drainage and Grading Considerations	39
2.7.5	Maintenance Considerations	39
2.8	Interim Treatment Guidance	39
2.8.1	Unique Benefits and Design Considerations.....	40
2.8.2	Materials	40
2.8.3	Maintenance Considerations	40
2.9	Integration with Stormwater Treatment Facility.....	40
3	Mountable Truck Apron or Pillow.....	41
3.1	Overview	41
3.2	Definitions.....	41
3.3	Applications.....	41
3.4	Design Guidance	42
3.4.1	Size and Material.....	42
3.4.2	Design of Mountable Area	43
3.4.3	Drainage.....	44

3.4.4	Interim Treatments	45
3.5	Accessibility Considerations.....	45
3.6	Maintenance Considerations	46
4	Bus Bulb	47
4.1	Overview	47
4.2	Definitions.....	47
4.3	General Benefits and Design Considerations.....	48
4.3.1	Benefits	48
4.3.2	Design Considerations.....	48
4.4	Applications.....	49
4.5	Bus Bulb General Design Guidance	49
4.5.1	Geometric Design Considerations.....	49
4.5.2	Location Considerations.....	50
4.5.3	Bus Bulb Furniture Considerations	50
4.6	Bus Bulb Design Considerations With A Protected Bike Lane	51
4.6.1	Type I Bus Bulb with Protected Bike Lane.....	52
4.6.2	Type II Bus Bulb with Protected Bike Lane.....	53
4.6.3	Constrained Situations with Bus Bulbs and Protected Bike Lanes.....	54
4.7	Interim Raised Bus Bulb With Bike Lane	58
4.8	Accessibility Considerations.....	59
4.8.1	Accessibility.....	59
4.8.2	Curb Ramps	60
5	Crossing Island	63
5.1	Overview	63
5.2	Definitions.....	63
5.3	General Benefits and Design Considerations.....	64
5.3.1	Benefits	64
5.3.2	Design Considerations.....	64
5.4	Applications.....	65
5.4.1	Intersections	65
5.4.2	At mid-block crossings	66
5.5	Design Guidance	66
5.5.1	Constructed Medians.....	66

- 5.5.2 Hardened Centerlines 69
- 5.5.3 Pavement Markings and Signs 70
- 5.6 Accessibility Considerations..... 70
 - 5.6.1 Design Considerations..... 70
 - 5.6.2 Signalized Intersection Considerations 71
- 5.7 Maintenance Considerations 71
- 6 Raised Crosswalk..... 72
 - 6.1 Overview 72
 - 6.2 Definitions..... 72
 - 6.3 General Benefits and Considerations 72
 - 6.3.1 Benefits 72
 - 6.3.2 Considerations 73
 - 6.4 Applications..... 74
 - 6.5 Design Guidance 76
 - 6.5.1 Construction Tolerances and Quality Control..... 77
 - 6.5.2 Geometry 77
 - 6.5.3 Pavement Materials, Markings & Signs 80
 - 6.5.4 Drainage Considerations to Crossing Profile..... 82
 - 6.6 Accessibility Considerations..... 84
 - 6.7 Maintenance Considerations 86
- 7 Neighborhood Traffic Circle or Mini-Roundabout 87
 - 7.1 Overview 87
 - 7.2 Definitions..... 89
 - 7.3 General Benefits and Design Considerations..... 89
 - 7.3.1 Benefits 89
 - 7.3.2 Design Considerations..... 89
 - 7.4 Applications..... 90
 - 7.4.1 Mini-Roundabouts 90
 - 7.4.2 Neighborhood Traffic Circles 90
 - 7.5 Design Guidance 91
 - 7.5.1 Geometry 91
 - 7.5.2 Mini-Roundabout Materials, Markings & Signs 94
 - 7.5.3 Neighborhood Traffic Circle Materials, Markings & Signs 95

City of Los Angeles Supplemental Street Design Guide

7.6	Special Cases	96
7.6.1	'T' Intersections.....	96
7.6.2	Community Identity Treatments.....	97
7.7	Accessibility Considerations.....	97
7.8	Maintenance Considerations	98
APPENDIX A: Supplemental Design Guide Details – Bureau of Engineering		
APPENDIX B: Supplemental Design Guide Details – Department of Transportation		

i. PURPOSE OF THIS SUPPLEMENT

The City of Los Angeles adopted the Mobility Plan 2035, which is the Transportation Element of the City's General Plan. The Mobility Plan 2035 established a 'Complete Streets' planning framework to design streets to prioritize the safety of the most vulnerable road users. The City launched the Vision Zero initiative to implement the safety-first policies of the Mobility Plan 2035. The purpose of this document is to provide supplemental design guidance for treatments that will be frequently installed to achieve this goal. It is anticipated the installation of these treatments will occur on all types of projects, ranging from street reconstructions to interim installations with temporary materials.

This document is a supplement to the following City documents:

- The City of Los Angeles Complete Streets Design Guide
- Bureau of Engineering (BOE) Street Design Manual and Standard Plans
- Department of Transportation (LADOT) Manual on Policies and Procedures

This supplement is based upon the City's Complete Streets [Design Guide, which was adopted by Los Angeles City Council on August 12, 2015](#). The complete streets design guide provides a preliminary level of guidance for all treatments in this guide (except truck aprons) by defining the treatment, explaining general benefits and design considerations, discussing potential applications, and providing basic dimensions. The City has additionally adopted the [NACTO Street Design Guide](#) and the [Urban Bikeway Design Guide](#), both of which may be used as guidance references. Where conflicts occur between this supplement and NACTO guides, the guidance in this supplement takes precedence.

The BOE and LADOT documents largely do not provide guidance on the treatments. This supplement therefore expands upon the content in the Complete Streets Design Guide to provide designers guidance to implement these treatments. The BOE and LADOT may incorporate design details of this supplement into the standard plans and drawings from time to time. When standard plans and drawings are adopted by LADOT or BOE from this supplement or other sources, those details will supersede drawings located within this supplement. The City may also update this supplement from time to time to add new topics, modify details or guidance based on actual implementation experience or evaluation, and to ensure it is coordinated with other City documents.

This document is intended for use by City staff, partner agencies, agency consultants, developers, and other relevant parties which may propose or be responsible for implementing these treatments within the City right-of-way.

ii. TYPICAL ORGANIZATION OF GUIDANCE WITHIN THE SUPPLEMENT

Designers should use permanent treatments (e.g., concrete curb for curb extensions) that have preferred dimensions. However, it is recognized that existing site constraints, project limits, budget constraints, project delivery types (reconstruction vs. retrofit), maintenance considerations, and the project proponent (e.g., City agency or private developer) will influence the selection of a preferred design strategy. Permanent treatments are preferred for city led projects, this guidance also recognizes the city will install interim treatments in order to achieve Vision Zero by 2025 or to address urgent safety needs. Private developers should not install interim treatments unless directed by the city.

This supplement generally provides the following structure for each element:

- Overview of Treatment
- Definitions
- General Benefits and Design Considerations
- Applications
- Design Guidance
- Alternative Options
- Interim Treatment Guidance
- Accessibility Considerations
- Maintenance Considerations

For some items, this format has been adjusted.

iii. AGENCY ROLES AND RESPONSIBILITIES

LADOT is responsible for design decisions related to traffic design (e.g., user priority allocation, striping and pavement markings, traffic signs, traffic signals and operations, and defining curb ramp placement, etc.). LADOT must approve all elements associated with these activities.

BOE is responsible for Street design decisions related to geometric design elements including horizontal alignment design (e.g., curb line setting, maximum safe speed on horizontal curves, superelevation and superelevation transition, minimum radius and maximum transition, horizontal curve design and minimum curve length, etc.) and vertical alignment design (e.g., grade controls including maximum, minimum and length, acceleration, grade breaks, cross slope, etc.). BOE is also responsible for reviewing and approving above and subsurface utilities. BOE approves the curb radius after consulting LADOT.

The maintenance duties for street infrastructure is split between two agencies. The StreetsLA is responsible for street pavement preservation, street sweeping, street maintenance, sidewalk repair, median maintenance, and street tree maintenance. StreetsLA must approve all elements associated with these activities.

LA Sanitation (LASAN) is responsible for watershed protection efforts which includes the maintenance of low impact development and green infrastructure treatments as well as the cleaning of stormwater infrastructure including catch basins and stormwater basins. LASAN must approve all elements associated with these activities.

Projects which impact elements within the realm of multiple agencies will require each agency to approve its implementation. The Streets Working Group will evaluate projects which propose the use of designs which deviate from this supplement. City Departments which may be impacted by these treatments, including the Fire Department, should be consulted prior to implementation of these treatments.

iv. MAINTENANCE AGREEMENTS

All treatments installed will require maintenance. It is preferable for designs to minimize maintenance efforts. However, to meet the Mobility Plan 2035 goals and policies, including Vision Zero and the city's Sustainability [Plan](#), it will be necessary to implement treatments which require maintenance effort and in some cases changes to standard maintenance practices.

The following design elements are proposed in this supplement to eliminate the need for costly drainage infrastructure and street regrading changes:

- **Narrow spaces between curbs** (e.g., Type II Curb Extensions and Floating Bus Bulbs) will require smaller street cleaning equipment or hand cleaning. These spaces are necessary to create protected bike lanes that maintain vertical and horizontal separation between bicyclists and pedestrians.
- **Drainage culverts** (e.g., Type I Curb Extensions and Raised Crosswalks) may be necessary in locations where it is not practical, feasible, or possible to modify existing stormwater infrastructure and an accessible pedestrian route must be provided. Drainage culverts will require additional manual labor to clean and the steel or concrete plates may require periodic maintenance or replacement.

In general, where vegetation is a part of a project near an intersection, a plan for maintenance must be developed as vegetation may create unintended sight distances challenges if it is not maintained.

StreetsLA and LA Sanitation (LASAN) are responsible for all maintenance activities unless a private partner maintenance agreement is developed. This may include vegetation on some projects to support the Sustainability Plan goals and to reduce stormwater runoff. In some cases, maintenance agreements between the City and adjacent private property owners or groups may be developed where the private property owners or groups agree to assume maintenance responsibility. The type of equipment required to maintain, the frequency of maintenance, and the responsible party should be identified in the Pre-Design Report. If a maintenance agreement is not developed it may not be feasible to implement the project.

v. DESIGN EXCEPTION

The Streets Working Group will evaluate projects which propose the use of design elements or guidance which deviate from this supplement or other city design guides or standards while implementing treatments in this supplement. Design exceptions must be submitted to the City Engineer for review and approval. The design exception application must include relevant information to allow the reviewers to understand the justification for the proposed change. This supplement specifies the minimum information that will be required to explain the justification changes requested for each treatment. At a minimum, design exception reports must include the following:

- An explanation of the justification for the design exception
- a scaled geometric plan identifying the treatment design (with supportive cross sections as necessary); the plan must show all vehicle lanes, parking requirements, sidewalks, curb ramps, existing curb locations, and key utilities

City of Los Angeles Supplemental Street Design Guide

- Existing stormwater flow must be identified; where installation of the treatment may result in ponding or flow re-routing, mitigating designs with supportive stormwater analysis must be provided
- Identify utility impacts and proposed mitigations if required
- the anticipated average and peak daily and hourly volume of the proposed design vehicle
- the anticipated average and peak daily and hourly volume of all traffic including pedestrians and bicyclists
- the proposed Mobility Plan 2035/LADOT Livable Streets street type designation or lack of designation

Additional requirements are stated for specific treatments or elements within this guide. The city may request additional information beyond these requirements.

1 CORNER RADIUS

1.1 OVERVIEW

Intersection design must balance the needs of all users of the street including motorists, transit vehicles, freight vehicles, emergency services (control vehicles), pedestrians, and bicyclists. The corner radius establishes the horizontal curve of the vertical curb at the corner formed by the intersection of two streets or between a street and driveway or street and alley. It has a significant effect on the interactions between users of the street.

This guidance should be used to determine the minimum corner radius by determining an appropriate design vehicle to minimize the size of the intersection. A design vehicle must be chosen considering street type, then a minimum sized corner radius is determined based on the accommodation of the design vehicles effective turning radius.

The existing BOE Street Design Manual provides limited guidance for determining an appropriate street intersection curb return radius (Section E 433.3). It provides a general statement suggesting a 25-foot standard radius but also states that “Curb return radii at each intersection must be considered individually” without providing guidance for how to select a design radius. This section provides the contextual guidance necessary to inform this decision to supplement Section E 433.3 requirements.

A corner with a larger radius can improve a motorists’ ability to turn into the nearest receiving lane and avoid encroaching into adjacent travel lanes when completing the turn. A larger radius can also reduce the likelihood that a larger vehicle may roll onto the curb or adjacent sidewalk; however, a large radius allows smaller vehicles to turn at higher speeds, decreasing motorist yielding to pedestrians and bicyclists. A large corner radius may require the installation of a diagonal curb ramp which is not preferred.

A corner with a small radius requires motorists to turn slower. This can reduce the rates and severity of collisions involving turning vehicles and vulnerable users as well as improve yielding to other street users who have the right-of-way. The use of a smaller corner radius can also simplify curb ramp design and allows for the preferred installation of directional curb ramps.

Corner radius design is determined by what effective radius is available and necessary for turning vehicles. In locations with multiple travel lanes, bike lanes, or on-street parking, the available effective radius can accommodate a wide range of vehicles allowing the actual corner radius to be minimized. A motor vehicle’s effective turning radius is the critical element to understand when designing a corner radius.

1.2 DEFINITIONS

Corner Radius¹: A geometrical measurement of the sharpness of the curb angle at intersections. It is also referred to as a curb return, curb return radius, or curb radius.

¹ Los Angeles City Planning Complete Streets Design Guide

Most Common Vehicle: In almost all locations, the most common vehicle negotiating turns will be a passenger vehicle.

Design Vehicle: The largest frequent user at a given intersection, used to help determine the effective turning radius that is necessary.

Control Vehicle: An infrequent user at a given intersection, usually a larger, less maneuverable vehicle, which should be considered in conjunction with the **Encroachment Policy**.

Effective Radius, RE: The effective radius is the minimum radius appropriate for turning from the right-hand travel lane on the approach street to the appropriate lane of the receiving street, accounting for the presence of parking, bike lanes, curb extensions, or other features; the effective radius is usually equal to the minimum inside turning radius of the design vehicle. Full height curb should be outside of the effective radius for pedestrians waiting on the sidewalk.

Minimum Inside Turning Radius: The minimum radius necessary to accommodate the smallest circular path of the inside wheel of the turning vehicle.

Actual Radius, RA: The radius prescribed by the curb line at an intersection; a portion of the actual radius may be mountable if it is designed to be a **Mountable Truck Apron or Pillow**.

Skewed Intersection: An intersection where two streets intersect at an angle less than 75 degrees (an acute angle) or greater than 105 degrees (an obtuse angle).

Full-Time Curb: Designated to be when active motorized traffic lane flow adjacent to the curb is not allowed.

Un-skewed Intersection: An intersection where two streets intersect at an angle between 75 degrees and 105 degrees with 90 degrees being the preferred angle.

Swept Path: The envelope encompassing the entire vehicle body, including any part of the vehicle structure (i.e. mirrors) which may be wider than the wheel-base, during a turn.

Bicycle Enhanced Network (BEN): As defined in the Complete Street Design Guide, a BEN is comprised of streets that prioritize bicycle travel by providing specific bicycle facilities and improvements. Improvements along the BEN primarily consist of right-of-way infrastructure improvements, signal timing infrastructure improvements, and end-of-trip facilities. Enhancements include protected bicycle lanes (or cycle tracks) that offer an increased degree of separation between bicyclists and the adjacent travel lanes (e.g., an on-street parking buffer between the vehicular travel lanes and the cycle track). In addition, the installation of protected bicycle lanes would likely include signalization enhancements for bicycles along with turning-movement restrictions for motor vehicles.

Neighborhood Enhanced Network (NEN): As defined in the Complete Street Design Guide, an NEN is comprised of local streets that benefit from pedestrian and bicycle-related safety enhancements while preserving the connectivity of local streets to other enhanced networks. There are many appropriate treatments for streets on the NEN including curb extensions, mini traffic circles, neckdowns, raised crosswalks, and diagonal diverters. These enhancements encourage lower vehicle speeds, providing added safety for pedestrians and bicyclists. They can also reduce vehicular traffic volumes by making the street less desirable for through traffic.

Pedestrian Enhanced Districts (PEDs): As defined in the Complete Street Design Guide, PEDs include streets where pedestrian improvements are prioritized to provide safe and enjoyable walking connections to and from major destinations within communities. PEDs are selected based on safety, public health, equity, access, social, and/or economic benefits. Examples of pedestrian enhancements include wayfinding signage, street trees, pedestrian-scale street lighting, enhanced crosswalks, automatic pedestrian signals, reduced crossing length (e.g., corner extensions and crossing refuge islands), sidewalk widening, and public seating areas.

Transit Enhanced Network (TEN): As defined in the Complete Street Design Guide, a TEN is comprised of streets that prioritize travel for transit riders. Moderate enhancements typically include bus stop enhancements and increased service, with transit vehicles continuing to operate in mixed traffic. An upgraded enhancement would include an exclusive bus lane during the peak travel period only, while comprehensive enhancements typically include transit vehicles operating in an all-day exclusive bus lane.

Vehicle Enhanced Network (VEN): As defined in the Complete Street Design Guide, a VEN includes a select number of arterials that enhance long-distance travel on corridors. Moderate enhancements typically include technology upgrades and peak-hour restrictions for parking and turning movements. Comprehensive enhancements can include improvements to access management, all-day lane conversions of parking, and all-day turning movement restrictions or permanent access control.

1.3 GENERAL BENEFITS AND DESIGN CONSIDERATIONS

The following are general benefits and challenges associated with smaller corner radii. Where bicyclists are operating on sidepaths (Class I bikeways) or separated bike lanes (Class IV bikeways) these benefits will apply to them as well as to pedestrians.

1.3.1 Benefits

- Can reduce the risk of collisions by encouraging slower motorists right turns.
- Can shorten the crossing distance (reducing exposure) for pedestrians.
- Can increase the visibility of pedestrians and bicyclists to approaching motorists, especially where curb extensions are used.
- Can facilitate the implementation of directional curb ramps and provide additional space for pedestrians waiting to cross the street.

1.3.2 Design Considerations

- Can result in larger vehicles (i.e. buses, delivery/garbage/construction trucks, street sweepers, and emergency vehicles) requiring encroachment (see Section 1.8: Encroachment Policy) to negotiate the corner.
- Routine curb mounting by larger vehicles can cause damage requiring replacement or repair.
- Curb mounting by large vehicles can strike pedestrians and bicyclists or damage existing utility and signal infrastructure, requiring constant maintenance and/or relocation.
- Where existing large radius corners are reduced, it may require existing utility and signal infrastructure to be relocated.

1.4 APPLICATIONS

A corner radius is required at the intersection of all streets, roads, driveways (Case 3), and alleys. The geometric design of the corner radii will vary based on the street classification, proposed street enhancements, the transportation context, and the type of vehicles.

As noted above, smaller corner radii can improve pedestrian safety by shortening crossing distances (reducing exposure), increasing pedestrian visibility, and decreasing vehicle turning speed. Smaller corner radii also provide better geometry for installing directional curb ramps at each corner, resulting in a straight direction of travel for pedestrians. Smaller curb radii are especially beneficial at intersections with pedestrian and bicyclist activity and intersections where crashes result from motorist failure to yield due to higher right turning speeds.

1.5 IDENTIFYING STREET TYPE (FUNCTIONAL CLASS & ENHANCEMENT)

The functional classifications and enhancements of intersecting streets influence the type of vehicles operating on the street and the street design features. The City of Los Angeles Mobility Plan 2035 identifies street types and enhancements throughout the City. The [Complete Streets Design Guide](#) (LA CSDG) identifies how street enhancements apply to different functional classifications; these are summarized in **Table 1-1**.

Table 1-1: Street Enhancements Applied to Functional Classifications

<i>Functional Classification*</i>	Street Enhancement			
	<i>Neighborhood Enhanced Network (NEN)</i>	<i>Bicycle Enhanced Network (BEN)</i>	<i>Transit Enhanced Network (TEN)</i>	<i>Vehicle Enhanced Network (VEN)</i>
Boulevard I		✓	✓	✓
Boulevard II		✓	✓	✓
Avenue I	✓	✓	✓	✓
Avenue II	✓	✓		
Avenue III	✓			
Collector	✓			
Industrial Collector	✓			
Industrial Local				
Local Standard	✓			
Local Limited				

*Refer to Standard Plan S-470 for standard street dimensions of each functional classification.

The [LADOT Livable Streets website](#) should be used as a reference to determine if a street enhancement has been determined for a street along a given corridor. Please note that all streets have not been classified; as such, the City Planning Department should be consulted to identify the street types.

Where a street type or enhancement cannot be identified to guide design vehicle selection, a design vehicle should be recommended by LADOT and approved by BOE following the guidance in **Section 1.6.2**.

In addition to street enhancements, arterial streets may be located in Pedestrian Enhanced Districts (PEDs), which are identified in the Los Angeles Mobility Plan 2035. The Mobility Plan should be used to determine if a PED is located along a given corridor prior to determining the appropriate street enhancement(s).

1.6 DESIGN VEHICLE

The effective turning radius of all vehicles which may arrive at an intersection need to be considered during design to avoid curb mounting and sidewalk encroachment. A design vehicle should be the largest frequent user at a given intersection, which is used to determine the required intersection effective corner radii. The street type (**Table 1-1**) is used to identify the preliminary design vehicle recommended for a variety of conditions.

1.6.1 Default Design Vehicle

The default design vehicle is a 30-foot long, single-unit truck (SU-30). There are several exceptions to the default design vehicle identified in **Table 1-2**, which are based on the functional classification and street enhancements of the intersecting streets. The corresponding effective turning radius accommodates a right turn based upon the minimum inside turning radius (see Table 1-3) required for the design vehicle.

Table 1-2: Design Vehicle Exceptions to the Default SU-30 Design Vehicle

Street A	Street B	Design Vehicle	Corresponding Turning (Effective) Radius
Local Streets and Streets on NEN	Local Streets and Streets on NEN	DL-27	16 feet
All Non-Local Streets, including enhanced streets	Local Streets and Streets on NEN	DL-27	16 feet
Local Streets and Streets on NEN	All Non-Local Streets, including enhanced streets	DL-27	16 feet
Streets on TEN	Streets on TEN	CITY-BUS	25 feet
Industrial Collector	Industrial Local or Collector	SU-40*	38 feet*
Truck Route	Truck Route	WB-67*	50 with oversteering*
Streets with mini-roundabouts	Streets with mini-roundabouts	SU-30**	30 feet

NEN = Neighborhood Enhanced Network; TEN = Transit Enhanced Network

**Designers should provide detailed AutoTURN or equivalent turning analysis, to support evaluation for specific corner design*

***The DL-27 may be an acceptable design vehicle for some residential intersections if the frequency of the SU-30 will be minimal.*

For the purposes of geometric design, it is important to note that each design vehicle has larger physical dimensions and a larger minimum turning radius than most vehicles in its class as shown in **Figure 1-1** (all dimensions from AASHTO Green Book except DL-27 which is based on field measurements). Therefore, the design vehicle dimensions represent minimum values.

Figure 1-1 Common Design Vehicle Profiles¹

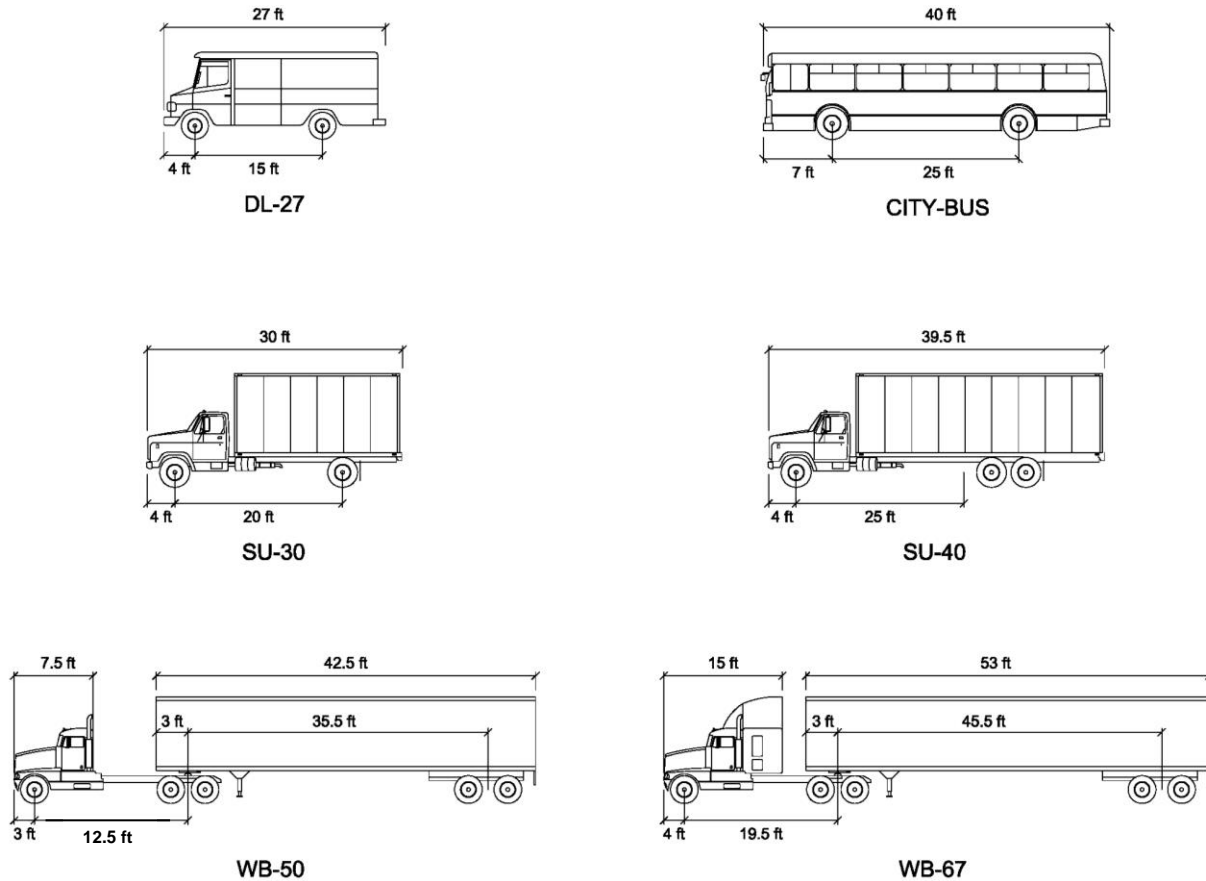

¹Figures copied from data provided within the 2018 AASHTO Green Book

Other common vehicles, which may be identified as the design vehicle or the control vehicle for specific corridors or intersections, are an articulated Metro bus, a LADOT DASH bus, LADOT Commuter buses, a garbage truck, or a fire truck. The designer should compare these vehicles to the default design vehicle or the design vehicle exceptions (**Table 1-2**) to ensure that they are accommodated.

Figure 1-2 provides a vehicle turning template for the DL-27. The DL-27 has the same wheelbase and operating characteristics as the DL-23. The DL-27 has a longer truck bed at the rear than the DL-23.

Figure 1-2 DL-27 Turning Vehicle Template¹

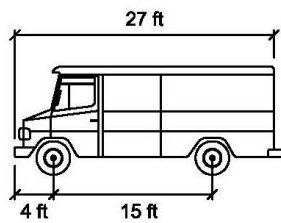
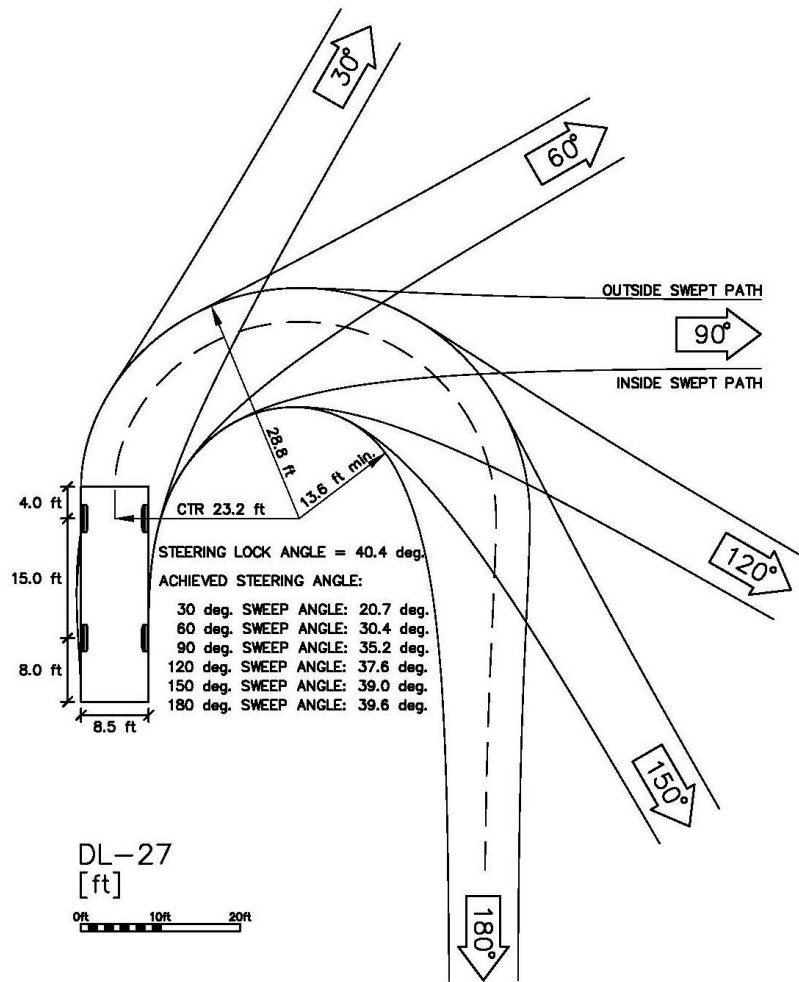

DL-27

	feet
Width	: 8.50
Track	: 8.50
Lock to Lock Time	: 6.0
Steering Angle	: 40.4

¹Figure created from AutoTURN Software

1.6.2 Selecting an Alternative Design Vehicle

When local context, project goals, or empirical data indicates a vehicle not listed in **Table 1-2** or **Figure 1-1** is desirable, or when a street enhancement has not been identified (**Table 1-1**), a Design Exception approved by the City Engineer is required. In addition to the minimum requirements stated in the Design Exception process, the report must include:

- Supporting AutoTURN or equivalent turning analysis to identify the minimum turning radius, effective radius, and the swept path of the vehicle

1.6.3 Minimum Turning Radii of Vehicles

Table 1-3 shows the minimum outside turning radius (left wheel) and minimum inside turning radius (right wheel) required to allow vehicles to turn right at speeds less than 10 mph without the use of oversteering for a wide range of vehicles that operate on City of Los Angeles streets. The minimum inside turning radius will be equal to the effective turning radius required at locations where vehicles are expected to turn from a curb side lane into a curb side lane. At these locations the minimum inside turning radii will inform the minimum Actual Radius required.

Table 1-3: Minimum Turning RADII for Common Vehicles

	Passenger Car ¹	Small delivery truck ²	Non-articulated Metro bus ¹	Single-Unit Truck ¹	Single-Unit Truck ¹	Interstate Semitrailer ^{1, 3}	Interstate Semitrailer ¹
	P	DL-27	CITY-BUS	SU-30	SU-40	WB-40 or WB-50	WB-67
Minimum outside radius (ft)	23.8	29.0	41.6	41.8	51.2	40	44.8
Minimum inside radius (ft)	14.4	16.0	24.5	28.4	36.4	19.3 ⁴	1.9 ⁴

¹Based on 2018 AASHTO Green Book

²Based on NACTO and NJDOT DL-23 vehicles, modified based on field measurements of actual delivery vehicles

³the WB-50 has the same performance characteristics as the WB-40 based upon review of 2004 AASHTO Green Book

⁴WB-50s and WB-67s will require significant off-tracking if designed to this minimum radius, therefore a vehicle swept path analysis is required for each intersection where one of these trucks will be the design vehicle.

1.6.4 Control Vehicle

A control vehicle is any vehicle larger than the design vehicle (e.g., moving or loading truck) that may occasionally operate through the intersection. The control vehicle will vary based on street functional classification and street enhancement, as well as the local context. The control vehicle is by default anticipated to encroach into adjacent and oncoming travel lanes to negotiate turns at intersections.

The control vehicle is discussed further in the **Encroachment Policy** and influences decisions made regarding the use of **Mountable Truck Apron or Pillow** to accommodate the turning needs of larger vehicles.

Emergency vehicles (e.g., police, fire, public utility or ambulatory services) are exempt from traffic operating rules (LAMC SEC. 80.05) when responding to an emergency call and thus should be checked that they are always accommodated while having the option to use all available roadway space.

1.6.5 Turning Vehicle Design Speed

To promote yielding to pedestrians, bicyclists, and motorists within intersections, intersections should be designed to encourage a 10-mph turning speed for passenger cars and a 5-mph turning speed for larger vehicles. These values should be used for the vehicle swept path analysis which is used to determine required effective and actual turning radius values.

Where higher turning speeds are desired, a safety assessment will be required to establish an appropriate turning speed and the resulting effective and actual radius required at the intersection.

1.7 RELATIONSHIP BETWEEN EFFECTIVE AND ACTUAL RADIUS

Choosing a design and control vehicle (**Table 1-2**) based on the Street Type (**Table 1-1**) is only the first step in determining the actual corner radius required. The functional classification and design vehicle selected do not mandate the use of the Effective Radius to establish a minimum corner radius. In many instances smaller corner radius may be used depending upon the influence of the following factors which should be considered to choose the final corner radius design parameters:

- The intersection skew
- The number of vehicle lanes
- The presence of bicycle lanes
- The presence of a permanent curb use (e.g., parking, loading, or bus stop)

1.7.1 Intersection Skew

Intersection skew, which is the angle at which two streets intersect, can have a significant impact on the design of a corner radius (**Figure 1-3**). The intersection skew has a significant impact on the turning needs of right turning vehicles, and impacts pedestrian and bicycle crossings, by lengthening the crossing distance, which increases exposure to potential conflicts with turning traffic.

Figure 1-3 Intersection Skew Impact on Intersection Geometry

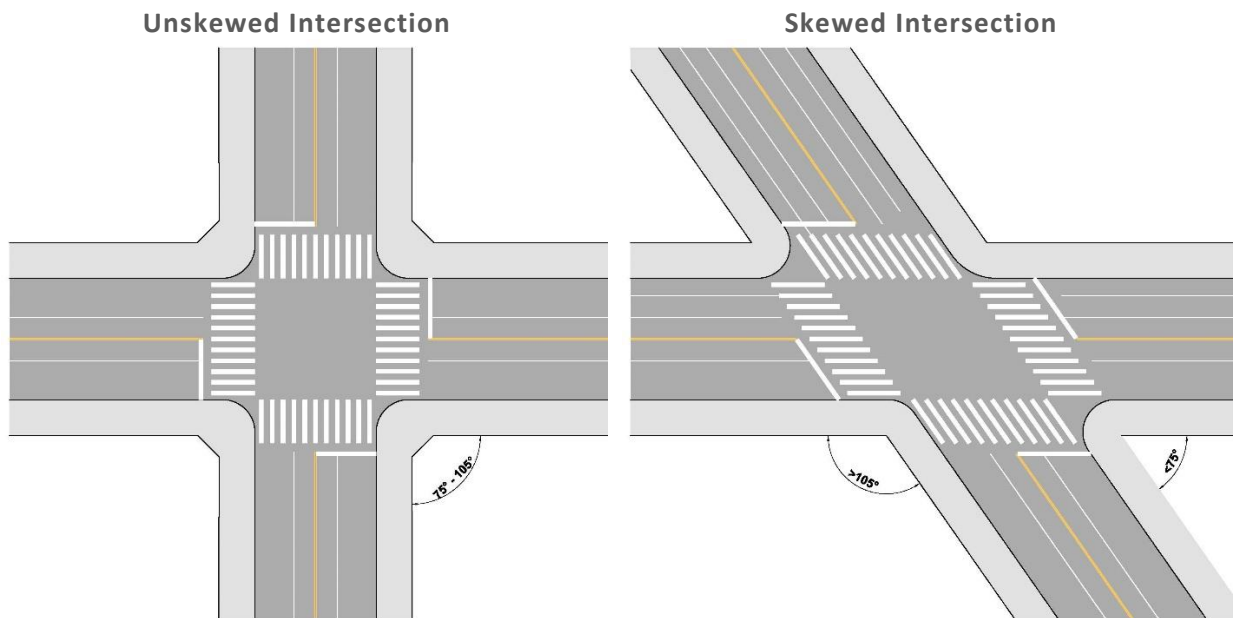

1.7.1.1 Unskewed Intersections

Unskewed angle intersections (with angles between 75 and 105 degrees) are preferred to minimize the size of intersections and to maximize sight lines between users. For all intersections, the corner effective and actual radius design must accommodate the minimum inside radius shown in **Table 1-3**.

1.7.1.2 Skewed Intersections - Acute Angle Quadrant

A swept path analysis will be necessary to identify the minimum turning radius and effective radius at skewed intersections. The use of **Table 1-3** is not appropriate.

Within a skewed intersection there are two quadrants that will result in an acute angle. A right turn within these quadrants presents unique challenges for larger vehicles. The increased length of the corner increases the degree of off-tracking for larger vehicles, which necessitates:

- greater encroachment into adjacent lanes, and/or
- wider outside lanes to accommodate the turn, and/or
- a larger corner radius.

To minimize the intersection size, it may be desirable to provide a channelized right turn lane to accommodate larger vehicles. A channelized right turn lane may be preferable to a larger corner radius to decrease the street crossing distance for pedestrians and bicyclists.

Where channelized right turn lanes are provided, it will be necessary to choose between a flat angle (> 140 degrees) or a right-angle (< 120 degrees) approach to the cross street (**Figure 1-4**). To ensure the channelized right turn lane promotes motorists yielding at pedestrian and bicycle crossings as well as to cross street motorists - a right-angle entry design is preferred. This design encourages lower turning speeds and improves the driver's view of people approaching crosswalks and motorists approaching from the cross street.

Figure 1-4 Channelized Right Turn Design Options



The use of flat-angle approaches should be limited to locations where:

- motorists have their own receiving lane on the cross street, and
- higher turning speeds are necessary for safe merging onto the cross street, and
- pedestrian and bicycle crossings are not allowed or infrequent, or traffic controls devices are provided to facilitate pedestrian and bicyclist crossings

A **Raised Crosswalk** should be considered at channelized right turn lanes where motorists do not face stop or traffic signal control (see LADOT Std. Drawing. S-483.1 and S-494.1) to encourage motorist yielding. They may also be beneficial at yield, stop, and signal control intersections where it is desirable to reduce encroachments into the crosswalk. The crosswalk should be located to allow one vehicle to wait between the crosswalk and the cross street (see LADOT Standard Detail 494.1).

1.7.1.3 Skewed Intersection - Obtuse Angle Quadrant

Within a skewed intersection there are two quadrants that will result in an obtuse angle. A right turn within these quadrants present fewer challenges to accommodating larger vehicles, but they also allow all vehicles to turn at higher speeds. It is preferred to reconfigure obtuse angle quadrants to an unskewed configuration (**Figure 1-5**). In some cases where the skew is not that flat, this can be accomplished with a **Curb Extension**. In most cases, there will be insufficient space to allow for a channelizing island to be constructed.

At unsignalized locations where right turning traffic presents safety problems to pedestrians in the crosswalk, a **Raised Crosswalk** may be desirable to encourage motorist yielding (see **Supplemental Design Guide Detail 600**). At signalized intersections where motorists are not yielding due to higher operating speeds, it may be necessary to consider a protected right turn phase.

Figure 1-5 Skewed Intersection - Obtuse Angle Quadrant Reconfiguration

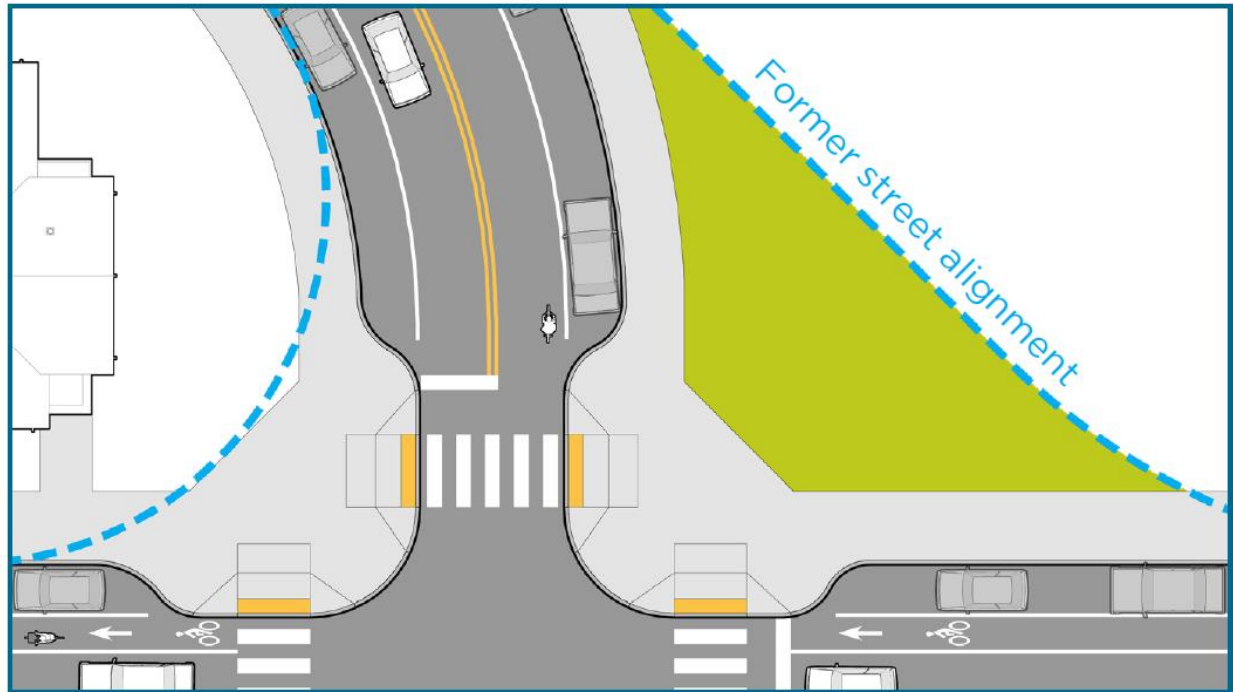

1.7.2 Determining the Actual Radius by Evaluating the Effective Radius

First it is necessary to identify the **Identifying Street Type (Functional Class & Enhancement)**. Next the **Design Vehicle** and its allowed **Encroachment Policy** must be determined. Based upon these decisions the actual curb radius can be determined. The smallest actual curb radius should be chosen to accommodate the required effective radius of the design vehicle considering allowed encroachment. A minimum actual radius of 5-feet should be provided (in 5-foot increments, with a 5-foot minimum radius being the starting point).

The design vehicle is used to determine the effective radius (RE) that needs to be accommodated at an intersection corner. In some cases, the actual radius (RA) will be the same as the RE; this is limited to locations where vehicles turn from the curb side lane on the approach street, into the curb side lane on the cross street, and where no bicycle lanes or full-time curb use is present. In all other cases, the RE and the RA can be different. Tables 1-4 through 1-6 provide approximate values for the RE for various conditions; however, if necessary, the City may request that the RE be labeled on the plans or an exhibit provided to verify the actual values.

For example, if the design vehicle is a passenger car (P) turning on a street with no parking, the effective radius required to make the turn would be 14.4 feet, therefore the actual curb radius should be 15 feet. The smallest radius shall be 5-feet for the intersection of two streets or a street with a driveway or alley.

1.7.2.1 Curbside Use Considerations

The presence of bicycle lanes or full-time curb use greatly impacts the ability to minimize the RA. Where parking is allowed along a curbed street (but restricted at the corners) and curb extensions are not provided, most vehicles (except for WB-67 and larger vehicles) are able to turn without encroachment onto adjacent lanes even where curb radii are relatively small. This is possible because the vehicles are

turning from a position horizontally separated from the curb which results in a relatively large RE being available for the vehicles.

As an example, as illustrated in **Figure 1-6**, an un-skewed intersection with parking on both of the intersecting streets and an actual radius of 15' has an RE of approximately 42' where vehicles turn into the near side curb lane. The RE is closer to 60' if they turn into the travel lane adjacent to the centerline. The RA could be reduced to 5' in this scenario while still providing a 30' RE to accommodate the default design vehicle (SU-30) turning into to the curb lane.

Figure 1-6 Example Effective and Actual Radius

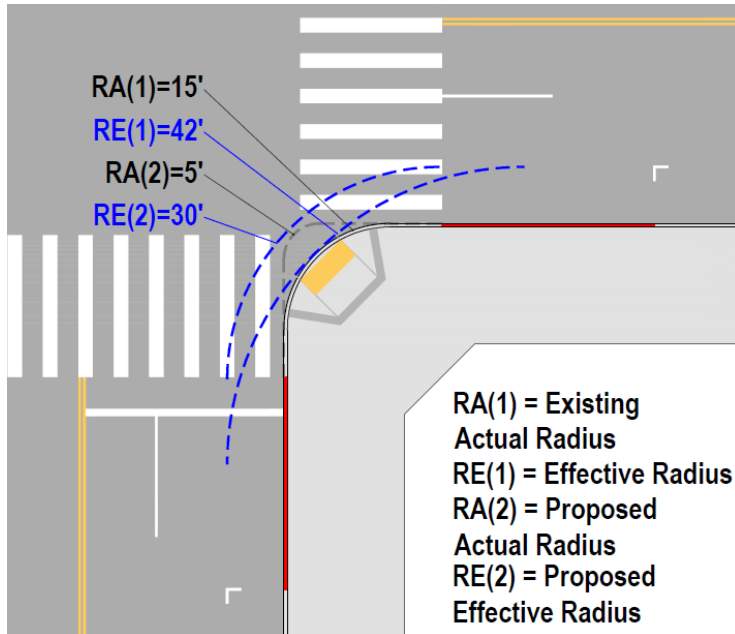

Since the presence of full-time curb use has such an impact on the ability to reduce the RA, an important consideration is the decision to install a right turn only lane (requiring a motorist to turn from the edge of the street) or to provide a de-facto right turn lane (by installing red curb).

Where vehicles must make a right turn from the edge of one travel lane to the near edge of the receiving travel lane, the corner radius will need to be based on the minimum turning radius of the selected design vehicle (**Table 1-3**). As illustrated in **Figure 1-7** where motor vehicle lanes are adjacent to the sidewalk, it can result in vehicles tracking over the diagonal pedestrian ramp landing area even where encroachment is allowed. This in-turn can result in pedestrians being struck by turning vehicles. For this reason, the use of directional curb ramps is preferred at locations where motorists turn from a curb lane.

Figure 1-7 Example RE and RA with a Right Turn Lane and No Parking on Approach Leg

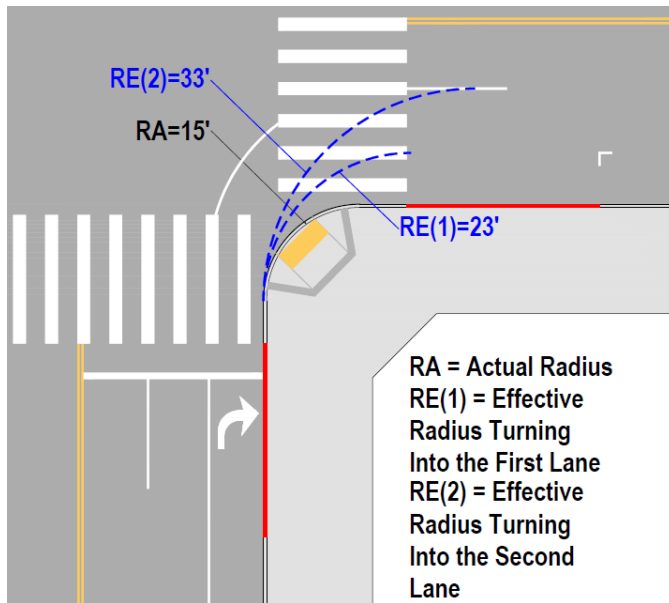

Locations which have unrestricted (by time of day) parking and bike lanes present greatest opportunity to reduce corner radius as shown in **Figure 1-8**.

Figure 1-8 Example of Curb Extensions on Two Streets to Reduce the RE

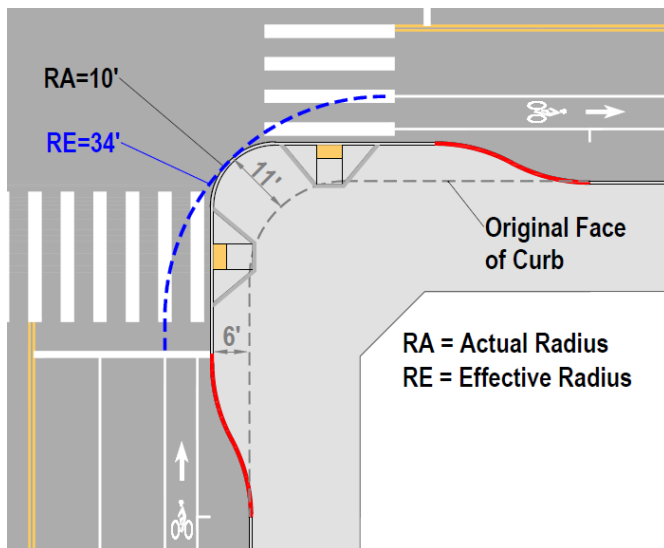

1.7.2.2 Design Vehicle RE and RA Tables for Various Curbside Conditions

The following tables summarize how the relationship between the RE and the RA changes when considering the current or future presence of bicycle lanes and/or full-time curbside use on one or both intersecting streets. These tables assume non-skewed intersections and **Table 1-4** and **Table 1-5** do not account for the possibility of encroaching into an adjacent lane. The RA may be smaller than the values identified in these tables if encroachment is allowable (see **Encroachment Policy**).

Table 1-4 Relationship Between RA and RE for the Default Design Vehicle (SU-30)

			Street A				
			Parking	No	No	Yes	Yes
			Bike Lane	No	Yes	No	Yes
Street B	Parking	Bike Lane					
	No	No		RA = 30' (RE ≈ 30')	RA = 25' (RE ≈ 30')	RA = 25' (RE ≈ 30')	RA < 10' (RE ≈ 30')
	No	Yes		RA = 25' (RE ≈ 30')	RA = 15' (RE ≈ 30')	RA < 10' (RE ≈ 30')	RA < 5' (RE ≈ 30')
	Yes	No		RA = 25' (RE ≈ 30')	RA < 10' (RE ≈ 30')	RA < 5' (RE ≈ 30')	RA < 5' (RE ≈ 35')
Yes	Yes		RA < 10' (RE ≈ 30')	RA < 5' (RE ≈ 30')	RA < 5' (RE ≈ 35')	RA < 5' (RE ≈ 45')	

Note: RA is the actual corner radius; RE is the effective radius

Table 1-5 Relationship Between RA and RE for DL-27

			Street A				
			Parking	No	No	Yes	Yes
			Bike Lane	No	Yes	No	Yes
Street B	Parking	Bike Lane					
	No	No		RA = 30' (RE ≈ 30')	RA = 15' (RE ≈ 20')	RA = 10' (RE ≈ 20')	RA ≤ 5' (RE ≈ 20')
	No	Yes		RA = 30' (RE ≈ 35')	RA ≤ 5' (RE ≈ 20')	RA < 5' (RE ≈ 25')	RA < 5' (RE ≈ 30')
	Yes	No		RA = 25' (RE ≈ 35')	RA < 5' (RE ≈ 25')	RA < 5' (RE ≈ 30')	RA < 5' (RE ≈ 40')
Yes	Yes		RA = 20' (RE ≈ 30')	RA < 5' (RE ≈ 35')	RA < 5' (RE ≈ 40')	RA < 5' (RE ≈ 45')	

Note: RA is the actual corner radius; RE is the effective radius

Table 1-6 assumes encroachment into the second lane, as this scenario is expected to almost always be acceptable for the CITY-BUS design vehicle, per the **Encroachment Policy**. Additionally, **Table 1-6** assumes that the CITY-BUS does not use an “oversteer” method of negotiating the turn; in some cases, using an “oversteer” will greatly reduce the actual and effective radii. These conditions are noted in the table.

Table 1-6 Relationship between RA and RE for CITY-BUS

			Street A				
			Parking	No	No	Yes	Yes
			Bike Lane	No	Yes	No	Yes
Street B	Parking	Bike Lane					
	No	No		RA = 30' (RE ≈ 30')	RA = 20' (RE ≈ 25')	RA = 20' (RE ≈ 30')*	RA = 15' (RE ≈ 30')*
	No	Yes		RA = 30' (RE ≈ 35')	RA = 30' (RE ≈ 45')*	RA = 20' (RE ≈ 40')*	RA = 10' (RE ≈ 35')*
	Yes	No		RA = 25' (RE ≈ 30')	RA = 20' (RE ≈ 40')*	RA = 15' (RE ≈ 40')*	RA < 5' (RE ≈ 40')
Yes	Yes		RA = 15' (RE ≈ 30')	RA = 10' (RE ≈ 40')*	RA = 5' (RE ≈ 40')	RA < 5' (RE ≈ 45')	

Note: RA is the actual corner radius; RE is the effective radius

*The designer shall consider if negotiating the turn with “oversteering” is appropriate, as it can reduce the RA and RE under these conditions

The tables demonstrate that the locations with the greatest difference between the RA and the RE are locations where full-time curb use and/or bicycle lanes are present on one, or both intersecting streets. These locations have been identified with light gray shading. These are locations where a **Curb**

Extension would be more effective at increasing pedestrian visibility and decreasing crossing distances than a small corner radius alone.

The tables also demonstrate that the least difference between the RA and the RE are locations where either bicycle lanes or full-time curb use (or both) are not present on one or both of the intersecting streets. These locations have been identified in dark gray shading. These are locations where a **Mountable Truck Apron or Pillow** should be considered to slow the turning speed of the most common vehicle.

At skewed intersections, the goal is to develop a design that removes or reduces the skew to minimize the size of the intersection. A swept path analysis may be necessary to determine the appropriate corner design.

1.8 ENCROACHMENT POLICY

Designing the corner radius for turning vehicles to encroach into adjacent vehicle lanes is an important strategy to reduce the RA at the intersection corner as illustrated in **Figure 1-7**. The design and control vehicle, along with the functional classification, street enhancements, and intersection control are factors that influence what type of encroachment is feasible. It is important to note that the *California Vehicle Code (CVC) Chapter 6, Section 22100* states that right turning vehicles must turn “as close as practicable” to the curb on the receiving lane. However, the California Commercial Driver Handbook, Section 2.7.6 – Space for Turns, explains that drivers of large vehicles may encroach into other vehicle lanes; as such, there is flexibility to reduce corner radii and allow for encroachment into other vehicle lanes.

The encroachment policy is:

The intersection corner should be designed so that the *most common vehicle* can negotiate a turn without encroachment into an adjacent or oncoming motor vehicle lane. Exceptions include:

1. The intersection corner should be designed so that the *design vehicle* can negotiate a turn without encroachment into an adjacent or oncoming motor vehicle lane. Exceptions include:
 - a. At low volume (<6,000 vehicles per day), two-lane streets, the design vehicle can use the entire width of the departing and receiving lanes, including oncoming travel lanes, to negotiate the turn.
 - b. At intersections where the minor leg is stop controlled and the major leg is uncontrolled, the design vehicle can use the entire width of the departing (if minor leg) or receiving (if minor leg) lanes, including oncoming travel lanes, to negotiate the turn.
 - c. At signalized intersections where the design vehicle can utilize multiple lanes on the receiving street to complete their turn; in this scenario it may be necessary to implement a “No Right on Red” restriction (this treatment should be implemented at signalized intersection on Local Street intersections, where Neighborhood Enhancements are identified, and where the design vehicle represents less than 5% of total turns at the intersection).
2. The intersection corner should be designed so that the *control vehicle* can negotiate a turn with encroachment. The following should be considered:

- a. Emergency vehicles are assumed to be able to use the entire street right-of-way to negotiate turns, including all adjacent and oncoming travel lanes.
- b. Large trucks are assumed to be able to use adjacent lanes on the departing and receiving street at all intersections (**Figure 1-9**); large trucks may use the entire street right-of-way on Local Streets (**Figure 1-10**).
- c. It may be necessary to recess a stop line on the intersecting street if the control vehicle makes regular turns at the intersection. This should be limited for use as a strategy only at locations where vehicle encroachment over a limit line would occur regularly and present operational or safety issues if not corrected.
- d. A dashed centerline may be used if the control vehicle makes infrequent turns at an intersection but requires space from the oncoming lane to negotiate the turn.
- e. Restricting turns may be necessary, especially when considering the use of traffic calming elements on Local Street; for example, the planning and placement of **Neighborhood Traffic Circle or Mini-Roundabout** should influence the selection of a control vehicle and may necessitate turning restrictions.
- f. In some cases, a **Mountable Truck Apron or Pillow** may be used to help provide additional space for the control vehicle when other options are not feasible.

Figure 1-9 Difference between designing for truck turns versus accommodating truck turns

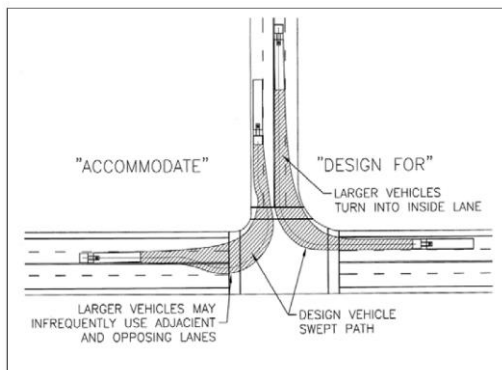

Image Source: City of Portland Freight Master Plan

Figure 1-10 Allowing full encroachment into all lanes to accommodate infrequent large vehicle turns from arterial and collector streets onto local streets

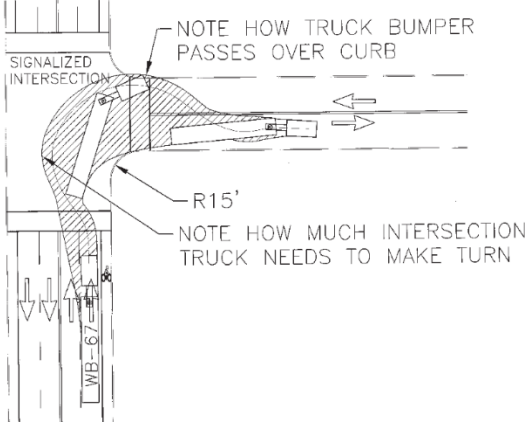

Image Source: City of Portland Freight Master Plan

2 CURB EXTENSION

2.1 OVERVIEW

A curb extension is created by extending the sidewalk at corners or mid-block locations into the street; typically, into a lane which is used for on-street parking. Curb extensions at intersections may extend into either one or multiple legs of the intersection, depending on the configuration of parking. Curb extensions may be attached to the curb (Type I) or floating away from the curb (Type II) to allow drainage to bypass the islands or a protected bike lane (Class IV bike lane) which is located between the parking or travel lane and sidewalk (**Figure 2-1**).

Figure 2-1 Examples of Curb Extensions

Type I – Attached



Type II – With Protected Bike Lane Intersection



Type II – With Sidewalk Culverts



2.2 DEFINITIONS

Curb Extension²: extends the curb line and sidewalk area out into the roadway, reducing the effective roadway width while increasing the sidewalk area for pedestrians. Curb extensions can be in the form of a corner bulbout, neckdown, chicane, or bus bulb located at intersection or midblock locations.

Type I Curb Extension: is a curb extension that is directly attached to the adjacent sidewalk.

Type II Floating Curb Extension: is a curb extension that is separated from the adjacent sidewalk. It may be defined by islands built in the street, by traffic control devices which define the desired edge or a combination of the two.

² Los Angeles City Planning Complete Streets Design Guide

2.3 GENERAL BENEFITS AND DESIGN CONSIDERATIONS

The following are general benefits and challenges associated with all types of curb extensions.

2.3.1 Benefits

- Reduces the pedestrian and bicycle crossing distance and increases their queuing space
- Physically and visually narrows a street to provide traffic calming, including streets with wide travel lanes and minimal to no on-street parking
- Reduces right turn motorist speeds
- Provides additional space to install directional curb ramps where sidewalks are narrow
- Improves the visibility between pedestrians and motorists at street crossings
- Prevents motorists from parking or stopping illegally
- Provides amenity space for utilities, signs, bus stop furniture, bicycle/scooter parking, public seating, and landscape elements
- Improves emergency access by restricting parking at intersection corners; provides easy to access fire hydrants
- Eliminates the need for buses to merge out of/into travel lanes when used for a bus stop (see **Bus Bulb** design guidance)

2.3.2 Design Considerations

- Can require larger vehicles (i.e. buses, delivery/garbage/construction trucks, street sweepers, and emergency vehicles) to encroach into other lanes to negotiate the corner (see **Corner Radius** design guidance).
- Inadequate curb radius resulting in routine curb mounting by larger vehicles can cause damage and require replacement and repair of curbs, curb ramps, as well as utility and signal infrastructure (see **Corner Radius** design guidance).
- Inadequate curb radius resulting in routine curb mounting by large vehicles can endanger people waiting behind the curb (see **Corner Radius** design guidance).
- Can present challenges with bus maneuverability when adjacent to bus stops; consider extending the curb extension to include the bus stop area, creating an in-lane bus stop (see **Bus Bulb** design guidance).

2.4 APPLICATIONS

Curb extensions can generally only be installed where on-street parking or other full-time stationary curb uses are present or planned; they cannot be used where a curbside peak period travel lane exists. In some limited cases where parking is not present, but curbside travel lanes wider than 16 feet exist, curb extensions can be used to narrow these curb lanes. They are recommended where:

- Pedestrians must cross 4 or more lanes of moving traffic (2 or more lanes per direction)
- Pedestrian volumes are high, near schools, parks, or at unsignalized pedestrian crossings
- Pedestrian collisions or near misses occur between turning motorists and pedestrians
- An increase in bus stop waiting area capacity is desired or to facilitate in-lane stopping of buses
- Motorists routinely park or stop illegally (including taxi and ride-share services) within a no parking zone approaching or departing pedestrian crossings

- It is used to provide space for ADA compliant, uni-directional curb ramps where sidewalks or shared use paths are narrow
- It is to provide space for utilities, signs and amenities such as bus shelters or waiting areas, bicycle parking, public seating, public art, street vendors, newspaper stands, trash and recycling receptacles and green infrastructure elements where they do not impede, pedestrian, cyclist, or motorist sight lines
- It is desired to provide a protected intersection to support a class IV protected bike lane or to transition a class II bike lane to a class IV protected bike lane
- A shared use path intersects a street and it is desired to increase the queuing area or to shorten the crossing distance of the street

The **Curb Extension Decision Tree (Figure 2-2)** allows for a quick assessment of the viability of a curb extension at an intersection. The first step identifies if a curb extension is viable based on the existing or proposed presence of parking, loading, bus bulbs, or protected bike lanes.

Figure 2-2 Curb Extension Decision Tree

Step 1

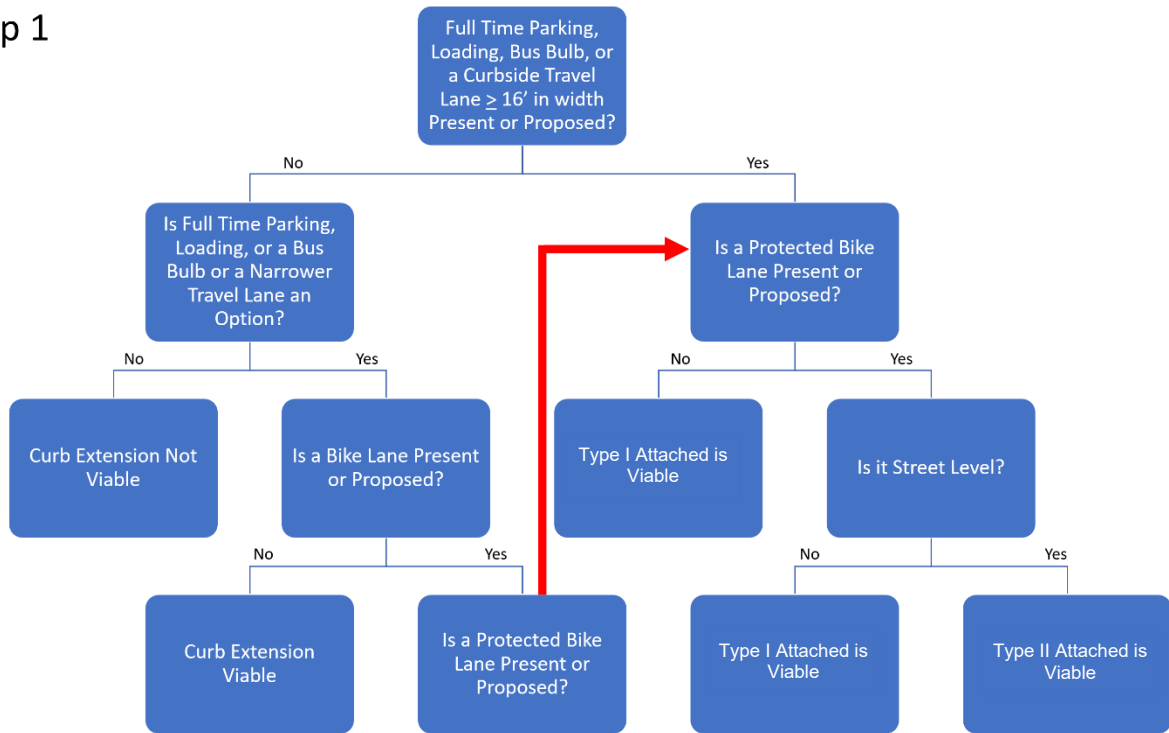

At locations where a curb extension is viable, the second step determines what type of curb extension should be considered based on existing curb ramp location in addition to drainage or utility impacts.

Step 2

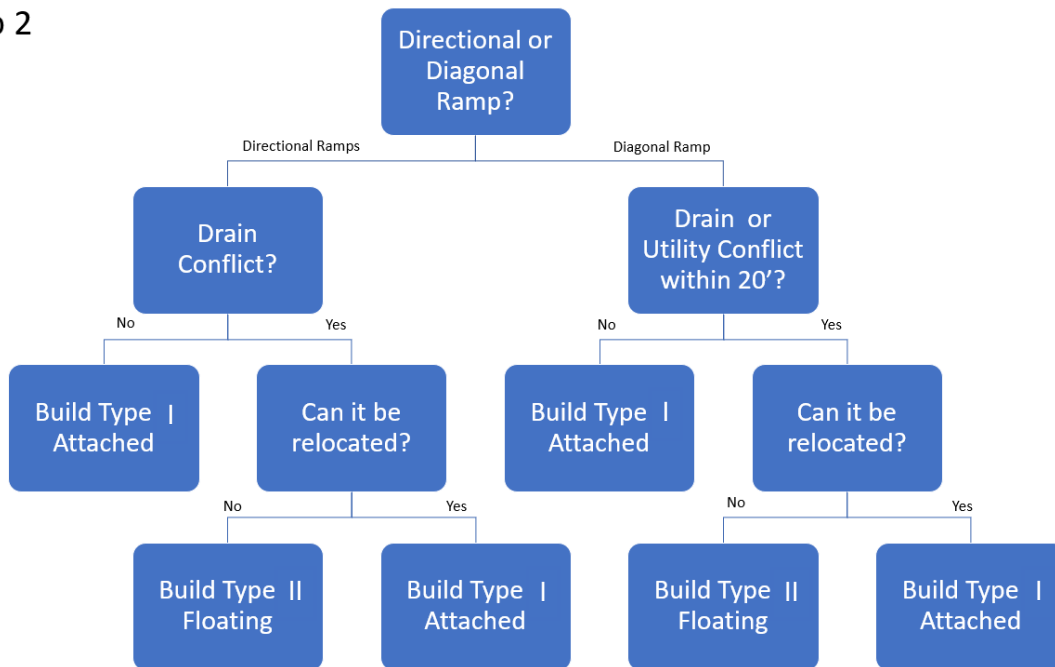

2.5 GENERAL DESIGN GUIDANCE

2.5.1 Geometry

- Corner designs should maximize pedestrian safety and comfort by minimizing the actual curb radius for the design vehicle while providing an adequate effective radius to accommodate the control vehicle. See **Corner Radius** for additional guidance for selecting the curb extension design radius along the turning vehicle path.
- The turning needs of larger vehicles should be considered in curb extension design; truck aprons can be used to ensure smaller vehicle speeds are managed while ensuring larger vehicles are accommodated and will not track over the curb or sidewalk. See **Mountable Truck Apron or Pillow** for additional guidance.
- Curb extensions should usually extend the full width of a parking lane, typically 8 feet from the curb, but not less than 6 feet from the curb.
 - Curb extensions should not extend into bicycle lanes or other travel lanes to provide a typical one-foot shy distance. The gutter pan, if present, should be outside of the bicycle lane. Curb extension should not preclude the future installation of bike lanes unless approved by the City.
 - At locations without parking, the minimum curb extension width is 4 feet from the curb.
- The minimum length of curb extension (measured along the curb line) shall be 10-feet or match the parking restriction length (i.e. red curb zone) approaching the street intersection (measured from edge of intersecting street), whichever is longer.
- The maximum length of curb extension depends on the use desired within the extension (e.g., stormwater management, bus loading, restrict parking).
- The reverse curve used to return the curb from the curb extension to the sidewalk should be constructed with 25-foot radii to accommodate street sweeping equipment. A smaller curb radius may only be used where the adjacent property owner assumes responsibility for gutter maintenance.
- Curb extension installation on both sides of a crossing is preferred, but where curb extension installation on one side is infeasible or inappropriate (i.e. no full-time parking), this should not preclude installation on the opposite side.

In limited situations, curb extensions may not be practical, as they may not achieve some of the benefits listed above. When one, or both, of the intersecting streets have a single receiving motor vehicle lane, and when encroachment (see **Encroachment Policy** for Encroachment Policy guidance) is not feasible, it may not be possible to create a curb extension substantial enough to allow the construction of directional ramps, or to significantly reduce crossing distances and improve visibility.

2.5.2 Plantings, Street Furniture and Other Utilities

- Planting, street furniture, sign, utility or other obstruction within the curb extension must not inhibit intersection sight distances by ensuring a clear zone of visibility between 36 inches high and 80 inches high from the ground measured 45 feet along the street edge from the point of intersection of the extended curb lines or street edges (see **Bureau of Engineering Street Design Manual Part E, Section 659**)

- Trees planted in a curb bulb are not considered intersection sight distance obstructions if they are maintained to ensure a clear zone of visibility and will achieve an eventual mature vertical clearance of 14 feet on street side and 8 feet on sidewalk side
- Plants in curb bulbs must be less than 2 feet in height at mature height including flowers
- Street furniture, utilities, trees, plantings, and other amenities must not interfere with pedestrian flow and plantings and trees must not become non-compliant projecting elements within the pedestrian path as they grow (ADA 307.4 and PROWAG R402.2)

2.6 ATTACHED CURB EXTENSIONS (TYPE I) DESIGN GUIDANCE

Curb extensions attached to sidewalks are preferred. They are easiest to install at locations without drainage structures, traffic signal equipment, or other utilities located where a directional curb ramps is desired; typically, a zone within 40 feet of the cross street. Supplemental Design Guide Detail 200 identifies attached curb extension details.

2.6.1 Unique Benefits and Design Considerations

The following benefit and challenges are unique to attached curb extensions.

Unique Benefits

- Reduced maintenance compared to Type II curb extensions
- Directional curb ramps should be feasible

Unique Design Considerations

- Drainage must be evaluated as part of the design to determine if the curb extension will significantly alter the drainage characteristics of a street.
- May require the relocation of existing storm drainage inlets and above ground utilities (e.g., fire hydrants, light poles, signal poles, signal cabinets, etc.) where they conflict with desired curb ramp locations
- May prevent or hinder the implementation of a bicycle lane or a protected intersection to complement a protected bike lane.
- May result in some debris buildup along curb line within the parking lane

2.6.2 Drainage and Grading

Attached curb extensions will lengthen the overall curb, thereby either: 1) causing the longitudinal slope at the flow line of the curb to be reduced, or 2) creating a low point at the upstream side of the curb extension.

If a low point is created, or if the longitudinal slope becomes too flat to maintain design ponding widths per the Bureau of Engineering Street Design Manual, additional drainage infrastructure will be required.

- If drainage infrastructure is required, the preference is to install a new inlet and tie into the existing storm drain conveyance system (see **Bureau of Engineering Standard Plans S-300, 311, 333, 343, and 381 Type II**); typically, this is accomplished by connecting a new lateral storm drain to an existing maintenance hole within the street conveyance system, often located in the roadway. Alternatively, the existing inlet can be remodeled to remove the inlet and the new inlet can be connected to this remodeled structure. This alternative uses the existing connection to the street conveyance system without requiring a new trench in the roadway. See **Sheet 5 of**

the **Supplemental Design Guide Detail 200** and **Bureau of Engineering Standard Plan S-343** for additional information.

- If no conveyance system exists and positive drainage along the curb is not maintained per the design criteria, a sidewalk culvert will be required to convey the flow in a straight line from the upstream side of the extension to the downstream side of the extension. See **Sheets 6 through 8 of the Supplemental Design Guide Detail 200** for additional information and Section **2.6.5** for maintenance considerations.

If a low point is created, the location should be evaluated for feasibility of a Vegetated Stormwater Curb Extension (see **Bureau of Engineering Standard Plan S-484**).

2.6.3 Alternative Design Options

2.6.3.1 Type I One-Side Extension

At some intersections, full-time curb use is only present on one of the two streets to provide a right turn only lane or bike lane (**Figure 2-3**). In this case, a curb extension is only possible on the intersection leg which currently has full-time curb use such as parking. The result is that the size of the curb extension will be smaller.

This may impact the ability to implement directional ramps for both crossings; however directional curb ramps are preferred. In these instances, it still may be desirable to build the curb extension if only to create space to install directional curb ramps. In these situations, the designer should consider setting the crosswalk back further from the intersection to create space to construct directional ramps or to avoid impacts to existing obstructions (e.g., signal poles).

Intersection sight distances, signal timing, out of direction travel for pedestrians, and curb use impacts should be considered when implementing a crosswalk setback.

Sheet 2 of the Supplemental Design Guide Detail 200 provides additional design guidance.

Figure 2-3 Type I Curb Extension with Parking on One Street Only

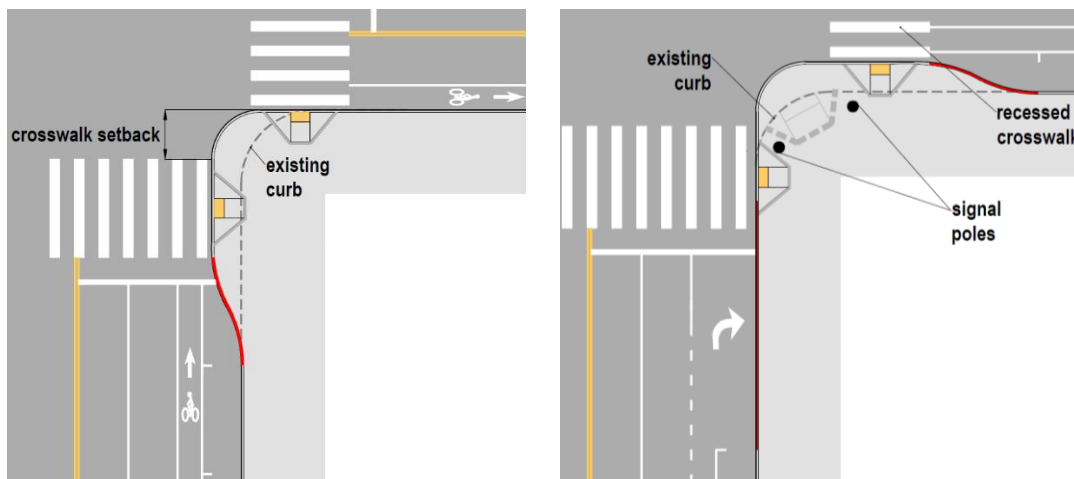

2.6.3.2 Type I Midblock Curb Extension

A mid-block curb extension provides many of the same benefits as curb extensions located at intersections. A mid-block curb extension also requires a full-time curb use be present to install it.

Consideration for drainage along the block length is necessary, as a mid-block curb extension may create a low point where stormwater is not able to travel around the new gutter line. In this case, strategies identified in **Section 2.6.2** should be implemented, or a **Floating Curb Extension (Type II)** should be used.

Figure 2-4 Type I Curb Extension at a Mid-Block Location

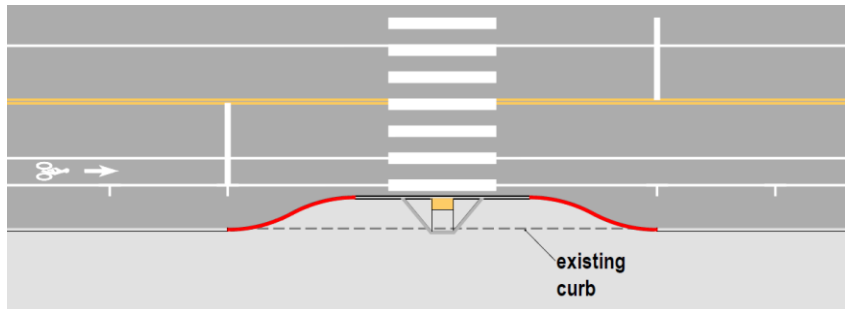

2.6.4 Accessibility Considerations

In addition to creating new low spots, the existing cross slope of one, or both intersecting streets may introduce challenges with curb ramp design and identification of the walkable area within the curb extension. See **Sheet 1 of the Supplemental Design Guide Detail 200** for additional information.

These challenges are as follows:

- Curb ramp design should consider the slope within the bottom ramp landing area. In many cases, a curb extension will allow the installation of directional curb ramps, which require a cross slope not exceeding 2% in all directions at the landing, and a counter slope of adjoining gutters and street surfaces immediately adjacent to the curb ramp not exceeding 5%. This may require additional regrading of the street to adjust the existing cross slope to meet guidelines. Refer to the curb ramp standards (**Bureau of Engineering Standard Plan S-442**) for additional information.
- To maintain a full height curb at the edge of the curb extension, the portion of the curb extension not within the curb ramp will likely have a reverse slope. Where this reverse slope exceeds 2%, this area should be non-walkable by pedestrians. Several strategies can be implemented to create a non-walkable area:
 - Utilize the space for plantings, amenities or above-ground utilities to discourage pedestrian passage
 - Create a raised planted or decoratively paved (e.g., cobbles) area
 - Install a minimum 6" height warning curb along the pedestrian walkway to separate and define the non-walkable area from the sidewalk (**Bureau of Engineering Standard Plan S-484**).

2.6.5 Maintenance Considerations

In order to ensure that the parking lane can be swept, and that debris does not become trapped behind the curb extension, the radius of the reverse curve connecting the curb extension to the existing gutter should be 25 feet minimum.

Plantings, street furniture, and other utilities may require periodic maintenance to maintain the clearances specified in **Section 2.5.2**.

Maintenance also includes, but is not limited to, debris clean-out of the culvert. Drainage culverts (e.g., Type I Curb Extensions and Raised Crosswalks) may be necessary in locations where it is not practical, feasible, or possible to modify existing stormwater infrastructure and an accessible pedestrian route must be provided. Drainage culverts will require a lid at pedestrian crossing which may require replacement if the lid is damaged, warps, or goes missing.

2.7 FLOATING CURB EXTENSION (TYPE II)

Where it is desirable to avoid impacts to existing drainage infrastructure or a protected bike lane is existing or planned for the street, floating curb extensions should be considered in place of attached curb extensions. Floating curb extensions are islands built in the street, disconnected from the adjacent sidewalk.

The **Supplemental Design Guide Detail 200** and **LADOT Standard Plan No. S-527.0** identifies floating curb extension details.

2.7.1 Unique Benefits and Design Considerations

The following benefits and challenges are unique to floating curb extensions.

Unique Benefits

- May be constructed without impact to existing diagonal ramps
- May allow drainage infrastructure to remain unchanged

Unique Design Considerations

- The floating curb extension does not create additional space on the intersection corner; if there is insufficient space to construct directional curb ramps at the existing corner, a Type II curb extension will not alleviate this condition.
- The floating curb extension may not reduce the effective radius for motor vehicles where existing diagonal ramps must remain; this may not effectively reduce right turn motorist speed as the diagonal curb ramp may also prohibit the installation of a truck apron or pillow (see **Truck Aprons Design Guidance Section 3.4**). Where space allows, it is preferable to provide vertical delineation along the design vehicle path supplemented with pavement markings. Where vertical delineation is provided, a minimum of 48" clear space must be provided at the landing outside of travel lanes. Refer to **Sheet 9 of the Supplemental Design Guide Detail 200** and **LADOT Standard Plan No. S-527.0** for additional information.
- At unsignalized intersections, visually impaired pedestrians may not be aware they need to cross to the floating island to begin crossing the street.

2.7.2 Alternative Design Options

2.7.2.1 *Type II One-Side Extension*

At some intersections it is only feasible to provide a curb extension on one of the two streets. In these cases, a Type II curb extension may be used on one leg. Nose radius shall be 25' minimum to allow street sweeper access.

2.7.2.2 Type II Midblock Extension

A mid-block curb extension provides the same benefits as curb extensions located at intersections. A mid-block curb extension also requires that full-time curb use be present to install it such as parking or a wide curb lane in excess of 16 feet in width (**Figure 2-5**). When a protected bicycle lane is present on the corridor, the offset between the Type II curb extension and the existing curb face needs to be sufficient to accommodate the bicycle lane (**Figure 2-6**).

Bus Bulb guidance should be followed at locations where a class II bike lane is routed behind a midblock bus stop. In both cases, nose radii shall be 25' minimum to allow street sweeper access.

Figure 2-5 Type II Curb Extension at a Mid-Block Location

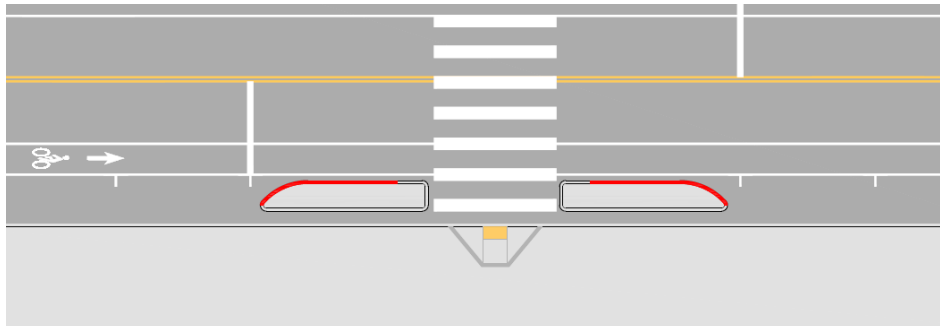
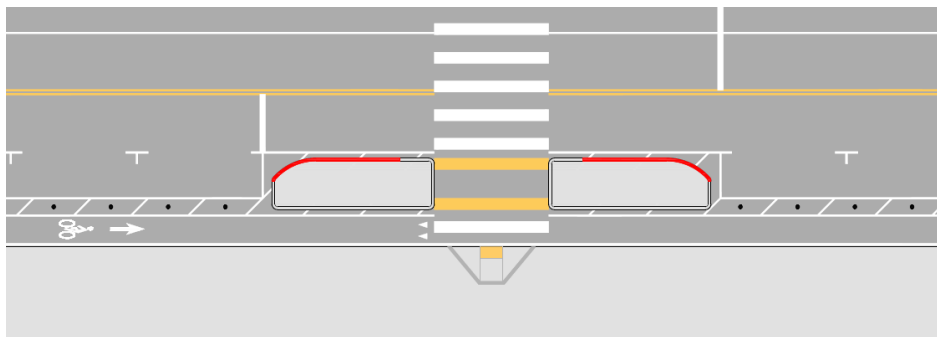

Figure 2-6 Type II Curb Extension at a Mid-Block Location with Protected Bike Lane



2.7.2.3 Type II Corner Extension with Protected Bike Lane

When a street level or intermediate level protected bicycle lane is present on one, or both intersecting streets, it is not feasible to construct a Type I curb extension. The Type II curb extension can provide additional benefits at the intersection corner when a protected bicycle lane is present (see **Figure 2-7**). A Type II curb extension can:

- Separate the bicycle and pedestrian crossings
- Provide space for turning bicyclists to queue outside of the path of cross traffic bicyclists
- Allow the bicycle crossing to be offset, to slow the turning speed of turning vehicles and create additional space for a turning vehicle to yield to crossing bicyclists and pedestrians

See Sheet 10 of the **Supplemental Design Guide Detail 200** and **LADOT Standard Plan No. S-527.0**.

Figure 2-7 Type II Two-Sided Curb Extension with a Protected Bike Lane

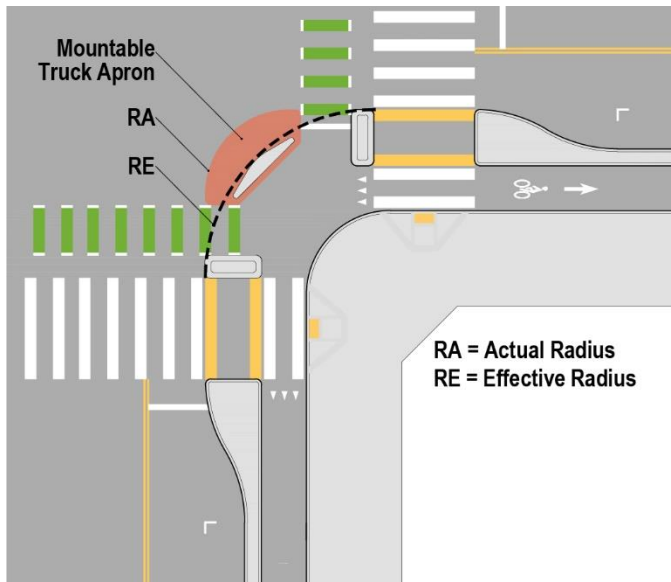

2.7.2.4 Type II One-Side Extension with Protected Bike Lane

When a Type II curb extension can only be implemented on one of the intersecting streets, the benefits listed above are lessened. In particular, the queuing space for turning bicyclists could be diminished resulting in the path of cross traffic bicyclists being blocked. Additionally, the offset between the bicycle crossing and the adjacent motor vehicle lane will be smaller (**Figure 2-8**).

Figure 2-8 Type II One-Side Curb Extension with a Protected Bike Lane

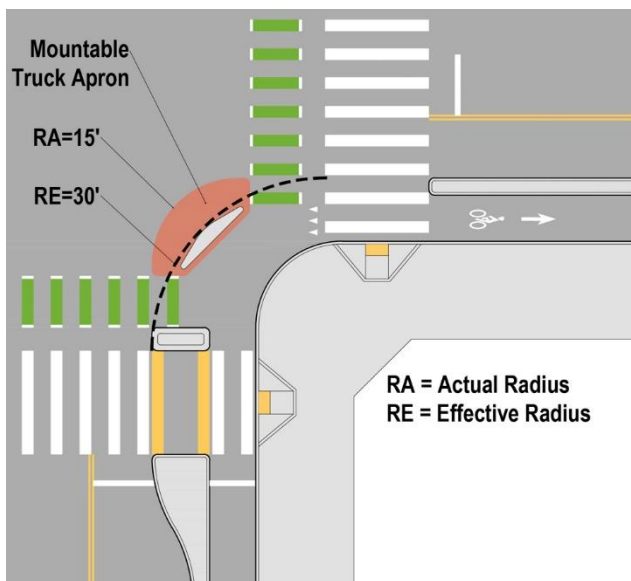

2.7.3 Signalized Intersection Considerations

In general, pedestrian crossing time will begin and end at the original curb, regardless of whether the floating island is sufficient for storage (6' minimum) or not. This will ensure adequate crossing time for all pedestrians, specifically those that are not waiting on the floating island. Pedestrian signals with

pedestrian push buttons (PPBs) to cross shall remain adjacent to ADA ramps at the original curb, consistent with standard LADOT design. All pedestrian waiting areas shall have detectable warnings in compliance with the Accessibility Requirements. LADOT will make the final determination on the appropriate crossing time at each location with these islands.

2.7.4 Drainage and Grading Considerations

Floating curb extensions will allow for existing drainage infrastructure and curb ramps to remain. The following considerations are necessary:

- The width of a drainage channel between the existing curb and the floating curb extension needs to be considered for drainage design. The default distance should be 2-feet as a larger gap may be confused for a bicycle lane or reduce the viability of a constructed curb extension.
- Constructing the curb extension with flexible delineators or bollards should be considered if a larger drainage channel is determined to be necessary (see **Section 2.8**).
- The drainage channel between the existing curb and the floating curb extension need not be covered unless it is intended to be traversable. An example location would be where a bus stop is located on a floating curb extension.
- The floating curb extension may be designed to incorporate stormwater management.

2.7.5 Maintenance Considerations

The drainage channel between the existing curb and the floating curb extension will require maintenance to remove debris which may collect. Additionally, the curb marking and associated signs that indicate a floating curb extension must be maintained over time, to ensure that they remain recognizable at all hours.

2.8 INTERIM TREATMENT GUIDANCE

In some instances, it may be desirable to install a Type I or II curb extension using temporary materials. This is used as a way to test a design prior to installing with final materials, typically for demonstration projects. Temporary curb extensions are frequently built using paint and vertical objects (e.g., flexible delineators or plastic bollards) to establish the outside edge. The interior of the curb extension should be painted as well, to distinguish that space as different from the adjacent street. The **LADOT Standard Plan No. S-527.0** identifies temporary curb extension details.

Figure 2-9 - Example of an Interim Curb Extension



2.8.1 Unique Benefits and Design Considerations

The following benefits and challenges are unique to temporary curb extensions.

Unique Benefits

- No impacts to existing utilities, curb and curb ramps
- Efficient and low-cost implementation Opportunity to evaluate impacts prior to final installation with permanent materials

Unique Design Considerations

- The pedestrian push button will continue to be located at the existing curb ramp, and the signal timing for the crossing will need to be calculated from that location.
- Additional maintenance of the temporary pavement markings and posts may be necessary; debris which may collect within the extension will need to be removed.
- Since temporary curb extensions do not alter the existing curb or curb ramps, they cannot accommodate the installation of directional curb ramps.
- Temporary curb extensions should use standard pavement markings to delineate the edge of the lane and the “no parking” areas on the approach and departure of the intersections corner. It is desirable for this area to be a solid, distinct color to differentiate it from the adjacent street. Flexible delineator posts should be used along the lane line to reinforce the edge of the curb extension.

2.8.2 Materials

- The temporary curb extension should be outlined with an 8” wide, white edge line
- Solid or patterned pavement marking should be distinct from the adjacent street, using a color that is not associated with standard traffic control (e.g., yellow).
- Flexible delineator posts or plastic bollards should be spaced no greater than 10’ apart, center-on-center within the “no parking” areas on the approach and departure; tighter spacing is recommended to establish the new corner radius. Use a minimum of 3 posts.

2.8.3 Maintenance Considerations

The curb marking and associated signs that indicate a floating curb extension must be maintained over time, to ensure that they remain recognizable at all hours.

2.9 INTEGRATION WITH STORMWATER TREATMENT FACILITY

Where existing sidewalks are narrow, or where right-of-way is limited, curb extensions may be desirable places to locate stormwater management facilities. It is possible to add stormwater management features to Type I or II curb extensions above. Care should be taken to ensure sight distances at intersections are maintained and compliant with the City's "Visibility Triangle" guidelines.

For more information, refer to the **Bureau of Engineering Standard Plan S-484**.

3 MOUNTABLE TRUCK APRON OR PILLOW

3.1 OVERVIEW

A truck apron (**Figure 3-1**) or pillow (**Figure 3-2**) is a design strategy used to accommodate the turning needs of large vehicles while slowing the turning speeds of smaller vehicles by reducing the perceived actual radius. A truck apron is designed to be mountable by larger vehicles to accommodate their larger effective turning radius needs. The mountable surface encourages the most common vehicles - a passenger (P) or delivery vehicle (DL-27) to turn outside the apron at a slower speed by design, thereby decreasing their effective turning radius.

Truck aprons can be installed with corner reconstruction, or in a retrofit condition. When they are installed as a retrofit, or when a gap is left between the mountable curb and the curb face to facilitate surface drainage, they are called truck pillows.

Figure 3-1 Example Truck Apron



Figure 3-2 Example Truck Pillow



3.2 DEFINITIONS

Mountable Truck Apron: mountable portion of a curb extension which is designed to discourage smaller vehicles from tracking over it while allowing larger vehicles to do so. It is attached to a full height curb requiring water to flow along its outer edge.

Mountable Truck Pillow: mountable portion of a curb extension which is designed to discourage smaller vehicles from tracking over it while allowing larger vehicles to do so. It is separated from a full height curb allowing water to flow along the curb edge.

3.3 APPLICATIONS

A truck apron/pillow should be used to reduce the actual corner radius to what is necessary for the most common vehicle. A truck apron/pillow cannot be designed without consideration for **Corner Radius** design guidance; the **Encroachment Policy** should be considered to help determine the actual radius.

Truck aprons/pillows may be used in conjunction with **Curb Extension**, **Bus Bulb**, or locations which have been reconstructed to reduce a **Corner Radius**.

3.4 DESIGN GUIDANCE

As defined in the **Corner Radius** design guidance, the effective radius should accommodate the design vehicle. When a truck apron/pillow is used, the effective radius should establish the full height curb located at the back of the truck apron. This will require the design vehicle to use the mountable portion of the truck apron/pillow to negotiate a right turn.

The actual corner radius, or the front of the truck apron/pillow, should be designed to accommodate the most common vehicle (typically the passenger car, P) without requiring them to mount the apron to negotiate a turn (**Figure 3-1**). This is typically 15' but in some cases, the actual radius can be even smaller, based on the presence of bicycle lanes or full-time curb use which change the effective radius or the allowable encroachment on the receiving street (see **Corner Radius**).

Except in industrial areas with regular truck use, the effective radius at the back of the truck apron should not be designed for the control vehicle, which would result in a larger corner radius which may negatively impact pedestrians. Encroachment should be considered when designing for the control vehicle; however, the mountable portion of a truck apron may influence the amount of encroachment that is required.

All signal equipment and bicycle and pedestrian elements (e.g., detectable warning surfaces, curb ramps, bicycle stop bars, etc.) should be located behind the effective corner radius, and therefore outside of the mountable surface area. In no circumstances should the design of the truck apron and corner radius result in the control vehicle mounting the sidewalk. All traffic signal equipment shall be placed per LADOT standard guidelines.

3.4.1 Size and Material

For constructability and visibility reasons, truck aprons/pillows should be a minimum width of 5 feet to be effective. Truck aprons/pillows where the distance between the effective radius and the actual radius is less than 5 feet are not feasible. A smaller distance will become difficult to visually differentiate from the surrounding surfaces and may be more difficult to construct.

Similarly, truck aprons/pillows should not be more than 15 feet in width, because the large mountable areas may not be effective at communicating the use of the space, which may confuse motorists and people trying to navigate the intersection. This is typical at skewed intersections. When the difference between the effective and actual radii is greater than 15 feet, consideration for full reconstruction of the intersection to square up the intersection is needed.

A design exception approved by the City Engineer will be required for the use of truck aprons larger than 15 feet in width. In addition to the minimum requirements stated in the Design Exception process, the report must include:

- The proposed geometric design of the truck apron including proposed pavement colors, textures, and pavement markings
- Supporting AutoTURN or equivalent turning analysis to identify the minimum turning radius, effective radius, and the swept path of the design and control vehicle

The pavement color and texture within the truck apron/pillow should be distinct from the adjacent street and sidewalk (**Figure 3-3**) to discourage most motorists from driving on this space. It also helps pedestrians understand that this is not an area where it is safe to wait. Colored and/or textured concrete helps to define the edge of the apron/pillow.

Reflective raised pavement markers may be used at the actual radius to ensure that the path of travel for the most common vehicle is visible at night. Retroreflective markings (edge lines and diagonal) on the apron and along the vehicle travel path around the apron may be provided following **LADOT Standard Detail S-526.0**.

Figure 3-3 Example of Truck Apron (San Francisco, CA)



3.4.2 Design of Mountable Area

A truck apron/pillow should incorporate a mountable section with a height between 2” and 3” to provide the desired traffic calming when the design vehicle represents less than 5% of the total right turns at an intersection.

When the design vehicle represents more than 5% of the total right turns at an intersection, or at locations where there is a transit enhancement applied to both streets, a truck apron/pillow with a maximum 2” height mountable section may be desirable. In some cases where tiered aprons are provided or a pillow is necessary, a portion of the outer apron or pillow may be less than 2 inches above the street where vertical deflection is not as important or to prevent the apron from obstructing an accessible pedestrian route as shown in **Sheet 5 of Supplemental Design Guide Detail 300**.

In some cases, a two-tiered approach to the mountable area may be appropriate. For example, where the control vehicle is a WB-50 and where buses are known to turn, the truck apron can be designed as follows (see **Figure 3-4**):

- The outermost edge of the apron can be designed with a 15-foot effective radius to accommodate delivery trucks (DL-27) without mounting the apron.
- The middle edge of the raised apron can be designed with a 30-foot effective radius and a 2-inch height mountable section to accommodate a BUS.
- The curbside edge of the raised apron can be designed with a 40-foot actual radius and a 3-inch height mountable section to accommodate the WB-50.
- A full height curb can be used to define the edge of the apron on the sidewalk edge.

Figure 3-4 Example Multi-tier Truck Apron (Portland, OR)

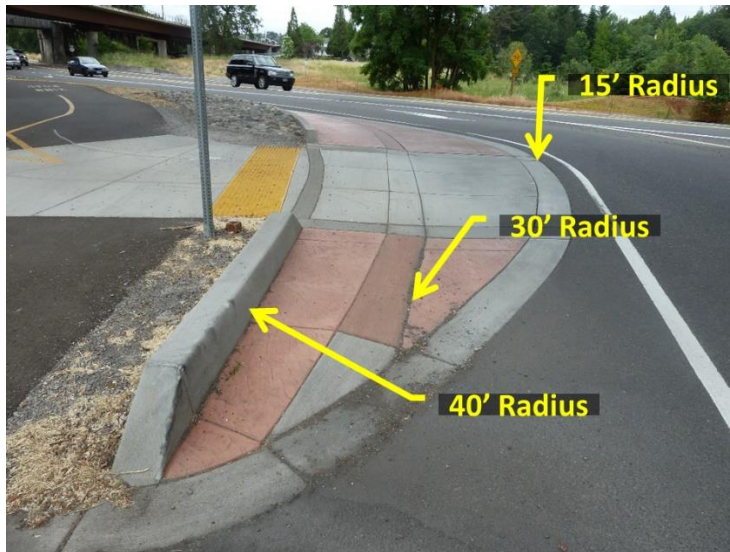

Truck apron/pillows can be used in conjunction with protected bicycle lanes, where they form part of the protected intersection as shown in **Figure 2-7** and **Figure 2-8** following the guidance in **Sections 2.7.2.3** and **Section 2.7.2.4**. The mountable portion of the apron should not be located within the bike lane as shown in **Figure 2-7**.

3.4.3 Drainage

When truck aprons/pillows are constructed in conjunction with curb extensions, the drainage guidance found in **Section 2.7.4** should be applied.

In some cases, constructing a truck apron by extending the corner into the intersection may create a new flow line or new low spots at the intersection corner. At these locations where new drainage infrastructure cannot be installed, a truck pillow will be necessary following the drainage guidance in **Section 2.7.4**.

3.4.4 Interim Treatments

Truck pillows allow the existing flow line to be maintained around the effective corner radius, therefore they are a useful strategy where it is not desirable to modify the existing curb ramp(s) or curb face. This may be useful when full corner reconstruction isn't possible, or as a quicker cost-effective safety improvement.

When a truck pillow is installed as a retrofit, and the existing corner has a single curb ramp, it is important to ensure the landing at the bottom of the ramp is accessible, keeping that area outside of the mountable pillow (**Sheet 3 of Supplemental Design Guide Detail 300**).

To ensure the truck pillow is visible to approaching motorists at the intersection, the no parking zones on either leg of the intersection should be reinforced with vertical objects (e.g., delineators) and pavement markings. The truck pillow should also be constructed to be visibly distinct from the street. This will discourage motorists from "cutting the corner" and encourage a lower speed turn around the truck pillow.

Another example of a retrofit installation that achieves similar goals as a truck pillow is a turn wedge (see **Figure 3-5**). A turn wedge is a rubber speed bump that is installed at the corner; this design allows a larger vehicle to negotiate the intersection corner, while encouraging a sharper and slower turn by the most common vehicle. Where there is insufficient roadway width and the curb lane is a "right turn only" lane, retrofit installations with mountable truck pillows would not be feasible.

Figure 3-5 Example of a Turn Wedge (Portland, OR)



3.5 ACCESSIBILITY CONSIDERATIONS

The accessible path across the truck apron should be clear and obvious to pedestrians. The pavement texture and surface slopes at this location should be smooth and meet accessibility standards. While texture is appropriate in other mountable portions of the apron, where the accessible path cuts through, the texture should be discontinued. Crosswalks should be marked up to the detectable warning surface through the truck apron to clearly distinguish the intended path of travel and ensure it is recognized to be part of the street. The detectable warning must be located behind the effective radius (See **Figure 3-2** and **Figure 3-4**).

3.6 MAINTENANCE CONSIDERATIONS

Truck aprons/pillows that are constructed as part of intersection corner reconstruction are preferred for longevity. The apron/pillow may be formed and poured in conjunction with the adjacent curb ramps and vertical curb and gutter, thereby reducing the number of pavement joints. Additionally, designing a truck apron as part of intersection corner reconstruction allows the drainage surface flow to be considered.

At locations with truck pillows, it is acceptable for water to flow over the top of the apron. One constraint with a truck pillow is that the stormwater flow line is between the mountable surface and the curb face. This can create a location that may require additional maintenance to keep curb ramp landings and flow line free of debris. This is particularly challenging at locations with existing diagonal corner curb ramps.

4 BUS BULB

4.1 OVERVIEW

Bus bulbs follow the geometric design guidance for a **Curb Extension** with the exception of changes to minimum island length and width. Bus bulbs may be attached to the curb (**Figure 4-1**) or floating away from the curb (**Figure 4-2**). Type II floating bus bulbs allow drainage to bypass the bus bulb. Near side and far side stops must follow **Corner Radius** guidance to establish the corner geometry (**Figure 4-3**).

Many bus bulbs are installed to minimize conflicts between buses and bicyclists by converting existing shared lanes or bicycle lanes into a protected bike lane at the bus stop. If the protected bike lane is at the same level as the bus bulb and sidewalk, it will have the same design characteristics as a **Type I**. If it is at an intermediate or street-level, the floating bus bulb will have the same design characteristics as a **Type II Curb Extension**. The decision for whether to construct a Type I or Type II Bus Bulb with a protected bike lane is determined by accessibility and drainage flow design needs.

Figure 4-1 - Type I Attached Bus Bulb



Figure 4-2 - Type II Floating Bus Bulb



4.2 DEFINITIONS

Bus bulb³: A form of curb extension created by extending the sidewalk at corners or mid-block locations into a parking lane or shoulder within the street to create a bus stop boarding and alighting area (bus platform) for bus service.

Attached Bus Bulb: A Type I curb extension helps improve bus schedule and operational performance by allowing buses to stop in the travel lane at bus stops. This reduces dwelling time and merging conflicts associated with re-entering traffic. It also adds furniture space that can be dedicated to bus amenities (e.g., shelters, benches, and kiosks) without encroaching into the sidewalk.

Floating Bus Bulb: A Type II curb extension allows a bike lane to be routed behind the bus platform, eliminating conflicts between bicyclists and buses. Similar to a Type II curb extension, a floating bus bulb is designed to allow buses to stop in the travel lane at bus stops.

³ Los Angeles City Planning Complete Streets Design Guide

Bus Turnout: A bus turnout allows a bus to stop outside of a travel lane by recessing the bus stop into the existing sidewalk, furnishing zone, or by removing on-street parking. A floating bus bulb (Type II Curb Extension – See **Floating Curb Extension** (Type II)) can be installed at locations where a protected bike lane is routed behind the bus stop boarding area.

Protected Bike Lane (Class IV Bike Lane): A protected bicycle lane, separated bicycle lane, or “cycle track,” is a type of bikeway that provides a physical separation between bicyclists, motor vehicles, and pedestrians traveling on the roadway.

4.3 GENERAL BENEFITS AND DESIGN CONSIDERATIONS

Bus bulbs that allow buses to stop in the travel lane have the following benefits and challenges.

4.3.1 Benefits

- Improves bus performance by eliminating the need for buses to maneuver into a curb space to board passengers, then merge back into the travel lane to continue along its route.
- May minimize conflicts and crashes between buses and motorists associated with buses merging into traffic from the stop.
- Provides space to install a bus shelter, additional seating, and/or off-board payment collection equipment outside the pedestrian walking zone.
- Discourages vehicles from parking or idling within the bus stop.
- Improves accessibility by creating additional space for boarding and alighting and reducing incidences of motorists blocking the stop thereby requiring bus patrons to board and alight from the street.
- Results in the removal of fewer on-street parking spaces than is required for bus turnouts.
- Far-side intersection placement allows near-side right turn lanes to remain or be provided.

4.3.2 Design Considerations

- Vehicle traffic in the travel lane is blocked while buses are stopped at a bus bulb which can increase motorist delay.
- Locations with in-lane stops with only one through vehicle lane may increase motorist delays, motorist crashes, or result in some motorists attempting to pass the bus in the on-coming lane
- Bus bulbs at near-side locations with heavy right turn vehicle movements may prompt unsafe vehicle maneuvers to pass stopped buses to turn right; such as driving into the opposing traffic lane on two-way, single lane streets.
- Drainage concerns, utility relocation, and street sweeping operations should be analyzed before implementation (see **Section 2.6.2**).
- Bus bulbs can conflict with planned or existing bikeways or require narrowing of a sidewalk or buffer strip to provide a protected bicycle lane behind a bus boarding area
- Near-side intersection placement may result in the removal or preclude the future use of a right turn lane which may increase motorist delay or result in some motorists turning right in front of the bus.

4.4 APPLICATIONS

- Locations determined through a transit planning process with LADOT and LA METRO both approving the specific stop location and bus bulb type
- Any location with transit service may incorporate a bus bulb, however bus bulbs will most typically be applied on multi-lane arterial corridors (with on-street parking) so that cars are able to pass stopped buses
- Streets with one through lane in each direction where bus priority is desired
- Locations where the on-time performance of major high-frequency bus routes operating with 5 to 20-minute headways (such as Metro Rapid lines) are hindered by having to merge back into the travel lane
- Locations where the existing sidewalk width is less than 8 feet in width to accommodate a bus shelter.
- Locations where it is desired to eliminate the conflict between buses and bicyclists by placing a protected bike lane behind the bus boarding area

4.5 BUS BULB GENERAL DESIGN GUIDANCE⁴

4.5.1 Geometric Design Considerations

Bus bulb lengths will vary based upon the type of bus(es) served at the stop and if the frequency of service results in multiple buses arriving at the stop at the same time. It is preferable for the bus bulb to extend the length of the bus and provide clearances of 20 feet between buses and 10 feet to adjacent crosswalks or intersections. In some cases, existing site constraints, utilities, and adjacent driveways may limit the length of the available space, but in all cases the bus should not protrude into intersections. In these locations, the minimum length of the bus bulb should accommodate front and rear boarding and alighting areas. **Sheet 13 of Supplemental Design Guide Detail 400.**

The corner geometry is established by the **Corner Radius** guidance.

Bus bulbs should preferably be 8 to 10 feet wide to comfortably accommodate a bus shelter and provide accessibility and the minimum 4-foot clear accessible route throughout the length of the boarding area (see **Accessibility Considerations**). Where the bus bulb is adjacent to a sidewalk clear of obstructions, the width may be narrowed to 6 feet on constrained corridors.

A minimum 5-foot by 8-foot clear boarding and alighting area is required which must be clear of railings and battered curbs. Where railings or curbs are present, a wider bus bulb will be required. If multiple buses service the stop, a boarding and alighting area is required for each vehicle. A bus deploying an accessible lift will use this space. This may include loading into a protected bike lane under constrained situations (see and **Section 4.6**).

The installation of a Type I or Type II bus bulb will require reconstruction of a portion of existing curb and the roadway. The designer may choose to use a gutter or to remove it depending upon the following conditions:

- Gutters can present a hazard to bicyclists, so they are not recommended for use within a bikeway for Type II floating bus stops with protected bike lanes.

⁴ Based on METRO Transfers Design Guide, March 2018

- The gutter may be used along the street edge of Type I or Type II bus bulbs where it is necessary to improve constructability or to manage water flows. Where provision of a gutter will result in unacceptable travel lane widths for the street segment in constrained locations, the gutter should be omitted.

Bus bulbs attached to the curb should follow the general design guidance for a bus bulb and for Type I **Curb Extension** as shown in **Figure 4-3**.

Figure 4-3 - Typical Bus Bulb Layout

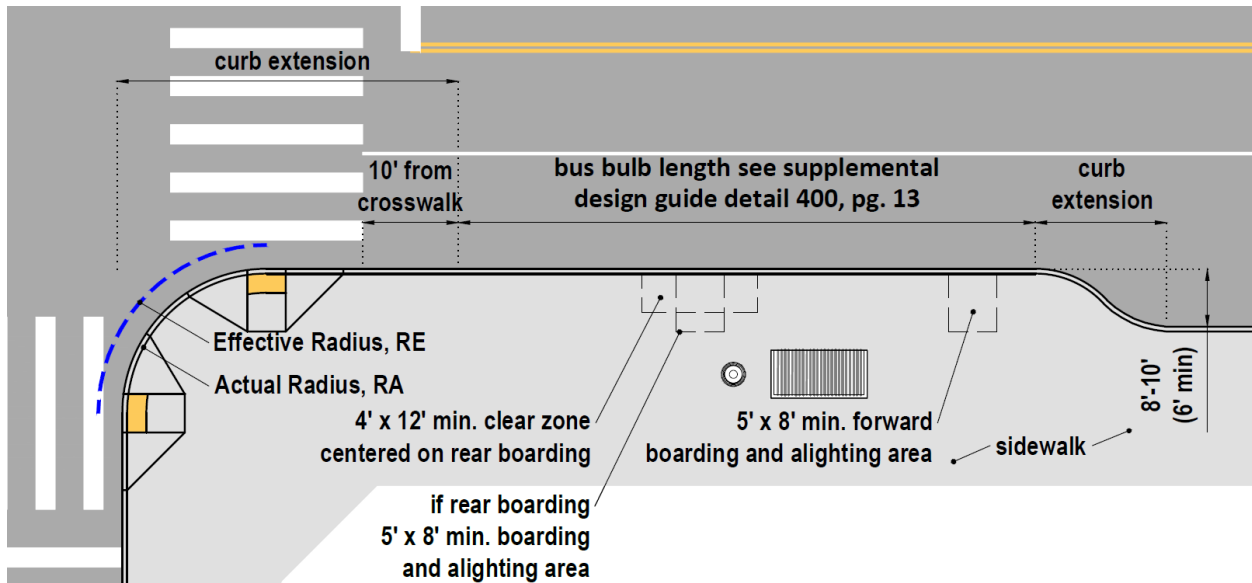

When applied at near-side stops, bus bulbs may require right-turn-on-red restrictions, as the addition of the curb extension may require that the design vehicle complete their right turn into the second lane on the intersecting street. For more information, refer to the Encroachment Policy (in **Corner Radius** design guidance).

The design of the bus pad should follow **Bureau of Engineering Standard Plan S-433**.

4.5.2 Location Considerations

Bus bulbs may be located at the near side or far side of intersections or midblock locations based upon transit provider needs and LADOT approval.

Bus bulbs may be located adjacent to driveways and alleys as long as the bus bulb design accommodates the needs of the turning vehicles swept path into and out of the driveway or alley (see **Corner Radius** guidance).

4.5.3 Bus Bulb Furniture Considerations

Shelter amenities should follow Metro and accessibility guidance. Shelters should be located to not obstruct the sight distance for motorists entering or exiting driveways, alleys, or streets near bus bulbs. Shelter designs which maximize visibility should be used where sight distance may be restricted. This may require the use of non-advertising bus shelters or the elimination of a shelter at some locations. To minimize the need for wider bus bulbs, shelters should not be aligned with the forward boarding and

alighting area which must have a minimum clear width of 8 feet of depth. Locating a shelter at this location would require a wider bus bulb.

Bus bulb furniture (signs, trash cans, benches) shall not impede the accessible route.

4.6 BUS BULB DESIGN CONSIDERATIONS WITH A PROTECTED BIKE LANE

Class IV protected bike lanes can be integrated with bus bulbs at mid-block, near-side and far-side locations. The decision for where the stop should be placed is determined by METRO and the City. A key decision for bus bulb design is the availability of space to construct the bike lane and drainage flow which will impact the bikeway elevation:

- Where stormwater flow is not impacted by the bus bulb or where the installation of additional drainage infrastructure is feasible, the protected bike lane may be at an intermediate or sidewalk level elevation.
- Where stormwater flow must remain at street level along existing gutter flow lines, a Type II floating bus bulb will be required with the protected bike lane remaining at street level.

The bike lane elevation has a direct impact on the strategies used to accommodate people with disabilities and where the resulting accessibility features are located on the curb extension. The elevation of the bike lane correspondingly has an impact on the acceptable minimum widths of the bike lane. The goal is to maximize the width of the bike lane while minimizing the potential for conflict between bus patrons and bicyclists.

Table 4-1 provides preferable and minimum widths for Class IV protected bike lanes behind a bus bulb for unconstrained and constrained conditions. Unconstrained dimensions will allow some bicyclists to pass other cyclists or to operate by side. It is expected that most retrofit conditions may require the use of constrained dimensions; however, the width of the bike lane should be maximized to the greatest extent practicable. The constrained condition should only apply within the limits of a bus bulb as this width will require single file bicycling. A full width bike lane should be provided immediately before and after the bus bulb following other guidance. The presence and type of curb, and the elevation of the bike lane, effect the allowable minimum width. Narrower widths are acceptable at sidewalk level bike lanes while wider lanes are necessary where curbs are present to account for a six-inch shy distance to the face of curbs.

Table 4-1 Class IV Protected Bike Lane (PBL) Widths behind Bus Bulbs

	BETWEEN VERTICAL CURBS	ADJACENT TO ONE VERTICAL CURB	BETWEEN SLOPED CURBS OR AT SIDEWALK LEVEL
ONE-WAY PBL			
PREFERABLE WIDTHS	6.5 – 8.5 feet	6.0 – 8.0 feet	5.5 – 7.5 feet
CONSTRAINED*	4.5 feet	4.0 feet	3.0 feet
TWO-WAY PBL			
PREFERABLE WIDTHS	10.0 – 12.0 feet	9.5 - 11.5 feet	8.0 – 10.0 feet
CONSTRAINED	8.5 feet	8 feet	7.0 feet

**The gutter must be contiguous across the entire bike lane width or gutters shall not be used.*

It is preferable for Class IV protected bike lanes to be routed behind the bus bulb to eliminate conflicts between bus patrons and bicyclists where space allows for a full width bus boarding and alighting area

(which must be a minimum of 8 feet in width) and a bike lane. The minimum total space for this design varies depending upon the protected bike lane elevation but requires at least 12 to 16 feet of available space.

Unconstrained designs separate bicyclists from bus passengers throughout the boarding and alighting area. The passengers are directed to cross the protected bike lane at defined crossing points when entering and exiting the bus bulb.

The following principals guide the design of the bus bulb with protected bike lanes:

- Guide passengers across the bike lane at clearly marked locations. Two pedestrian crossings are recommended, but not required. Railings, planters or other treatments can be used to channelize pedestrians, particularly those who are visually impaired, to crossing locations. Vertical elements should consider shy distances when placed adjacent to the bike lane. They must also not impinge on the minimum boarding and alighting area.
- Provide clear direction (signage, pavement markings) to bicyclists that they are expected to yield to pedestrians crossing the bike lane at the crossings.
- Preserve the minimum boarding and alighting area (5-feet by 8-feet) within the floating bus bulb, in-line with the pedestrian access route.
- Provide clear sight lines between pedestrians and bicyclists at expected crossing locations. If bus shelters are provided, ensure that the shelter structure or shelter advertising do not obstruct sight distances
- Provide an accessible wheelchair space within the shelter

4.6.1 Type I Bus Bulb with Protected Bike Lane

Bus bulbs with sidewalk level protected lanes generally follow the guidance for Bus Bulbs and Type I **Curb Extension**. To maximize separation between pedestrians and bicyclists and to delineate the separate spaces, the design requires the following as shown in **Figure 4-4**:

- 8 to 10 feet wide bus boarding and alighting area to allow space for a bus shelter
- Physical separation of the boarding and alighting area and bike lane provided by railings, shelters, planters or other continuous features to guide pedestrians to defined crossings
- Marked pedestrian crosswalks of the bike lane at the front and back of the stop
- Directional indicator separating the bike lane from the sidewalk to guide people with vision disabilities to the pedestrian crossings as there is not a detectable edge present between the bike lane and sidewalk; alternatively, an intermediate level bike lane can be provided with a minimum 2-inch curb reveal to create a detectable edge along the sidewalk (see **Figure 4-5**)
- Green color pavement is recommended to differentiate the sidewalk from the bike lane
- Consider raised crossings of side streets if a near-side bus bulb diminishes motorist approach sight distance or increases the effective turning radius (see **Raised Crosswalk**).

Figure 4-4 - Example Near-side Attached (Type I) Bus Bulb with Protected Bike Lane



4.6.2 Type II Bus Bulb with Protected Bike Lane

Bus bulbs with street level protected lanes generally follow the guidance for Bus Bulbs and Type II **Curb Extension**.

A street level option is preferable where it is necessary to maintain water flow along an existing gutter. Where drainage is not a primary consideration and it is desirable to provide a detectable edge between the sidewalk and bike lane, an intermediate level bike lane can be provided with a minimum 2-inch curb reveal to create a detectable edge along the sidewalk.

In addition to the prior design principals, the following design techniques should be considered when designing a floating bus bulb with a protected bike lane:

- Where on-street parking is not present, it may still be possible to implement a floating bus bulb along a corridor with Class IV protected bike lanes; the bike lane should taper away from the adjacent motor vehicle lane towards the curb to create space for the bus stop. This design may have impacts to the adjacent sidewalk zone (see **Figure 4-6**).
- Maintain an appropriate sidewalk width, which is typically wider than the minimum pedestrian access route.
- If necessary, narrow the bike lane along the bus stop to maintain an accessible sidewalk and bus bulb in constrained areas (see **Section 4.6.3**).
- It will be necessary to provide curb ramps to connect the floating bus bulb to the sidewalk. At a minimum, one curb ramp must be provided for this purpose. It may be at the front or rear area of the bus bulb to avoid impacts to utilities, poles, trees, or other obstructions. Where space is available, it is preferable to provide two curb ramps – one at the front and one at the rear as shown in **Figure 4-4** through **Figure 4-6**.

- Integrate the boarding and alighting area into the pedestrian crossing path at the intersection for convenient access (see **Figure 4-6** and **Accessibility Considerations**).
- Where a two-way protected bike lane or sidepath is provided, a solid yellow center line should be located on the bikeway to discourage wrong-way passing movements along the length of the platform; clearly delineate direction of travel and yielding responsibilities, and alert pedestrians to “look both ways” for two-way bicycle traffic.

Figure 4-5 - Example Midblock Floating Bus Bulb

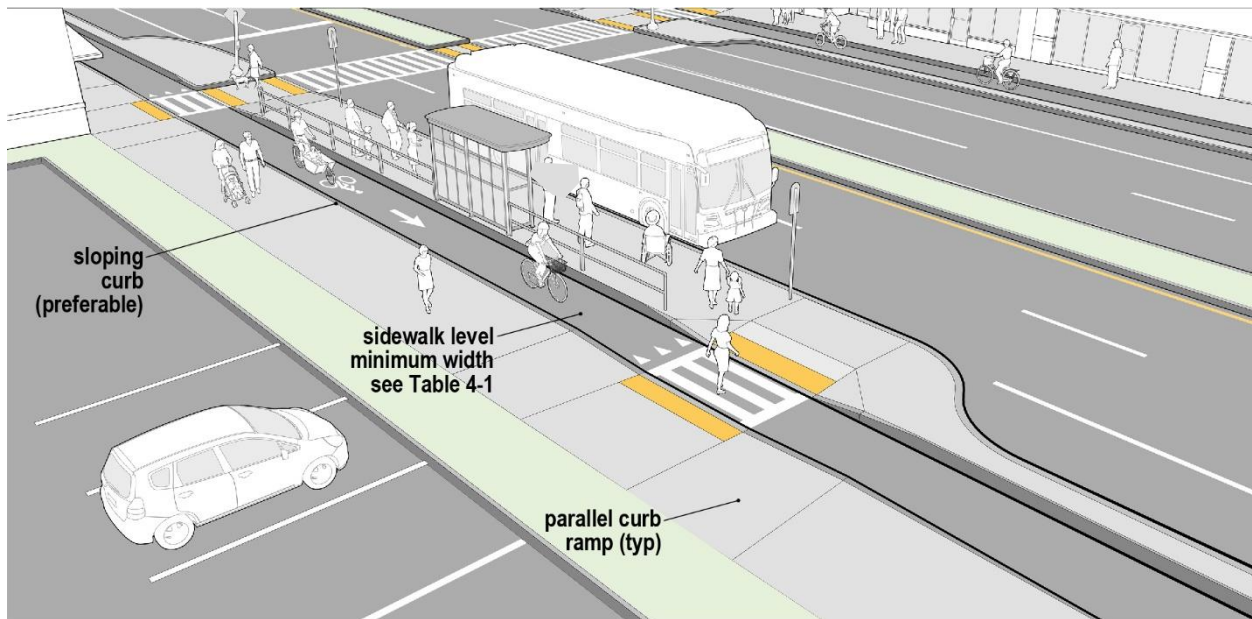
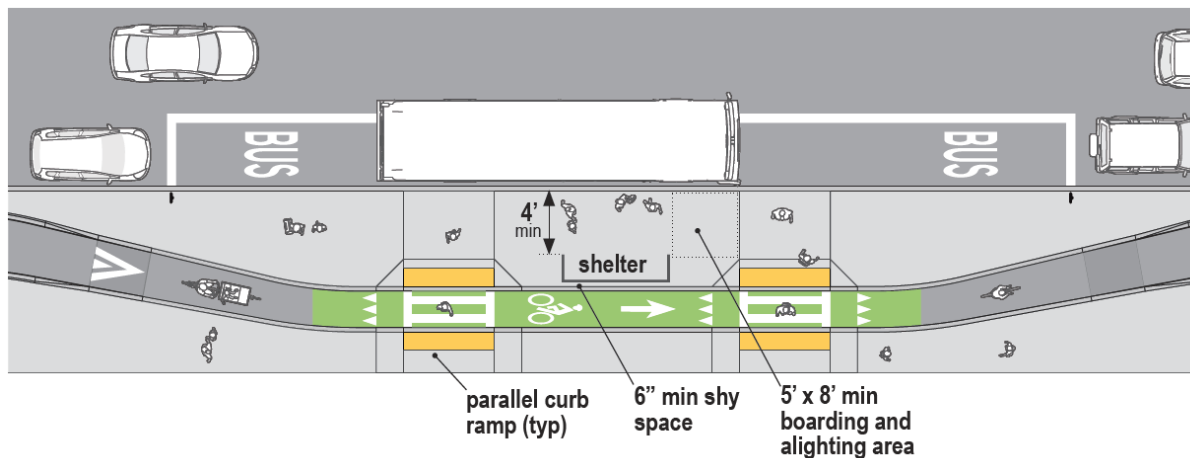

Figure 4-6 - Floating Bus Bulb Accessibility Requirements



4.6.3 Constrained Situations with Bus Bulbs and Protected Bike Lanes

Where it is not possible to maintain the bike lane width, bus bulb width, and an accessible sidewalk width at a floating bus bulb, narrowing the bike lane and/or boarding and alighting area may be

considered. Constrained designs will require bicyclists to cross through the bus passenger boarding and alighting area and/or to operate within a constrained width bike lane. It will not be possible to direct bus patrons to cross the protected bike lane at defined crossing points when entering and exiting the bus bulb and it will therefore become critical for bicyclists to stop and wait while buses are loading.

While accommodating pedestrian boarding and alighting across the raised bicycle lane is not ideal, nevertheless conflicts between bicyclists and pedestrians present a lower injury severity than conflicts between vehicles (including transit vehicles) and bicyclists.

The following design options may be considered for these constrained situations in order of preference.

4.6.3.1 Raised Bike Lanes with Narrow Boarding and Alighting Area

A floating bus bulb with a minimum bike lane width (**Table 4-1**) separate from a minimum width bus boarding and alighting area is preferred over a shared space, even in locations where the raised bike lane design could allow for greater width in the bikeway; the floating bus bulb removes bicyclists from the boarding and alighting area, reducing conflicts between bicyclists and pedestrians

The following should be considered in design:

- The boarding and alighting area is 8 feet inclusive of the bike lane.
- A minimum 4-foot boarding and alighting area should be provided outside the bike lane to:
 - 1) prevent people from stepping into the bike lane from the bus, and
 - 2) to create space for the deployment of an accessible ramp from the bus without the ramp extending into the bicycle lane (see **Figure 4-7**).
- The width of the bike lane should be as wide as practical and level with the adjacent sidewalk to maximize pedestrian queuing space.
- Bus shelters should be located on the sidewalk to maximize the boarding and alighting area and minimize bicyclist crash risk with fixed objects.
- To minimize conflicts between bus patrons and bicyclists the following are recommended:
 - 1) provide signs or pavement markings notifying bicyclists to stop for buses and pedestrians who are boarding or alighting the bus.
 - 2) define WAIT areas for pedestrians to clarify they should wait outside of the bike lane when waiting for a bus to arrive
 - 3) highlight the bicycle lane with green colored pavement to throughout the length of the bus platform. Due to the narrow width, railings between the bike lane and boarding area are not recommended.

Figure 4-7 - Raised Bike Lane with Narrow Boarding/Alighting Area

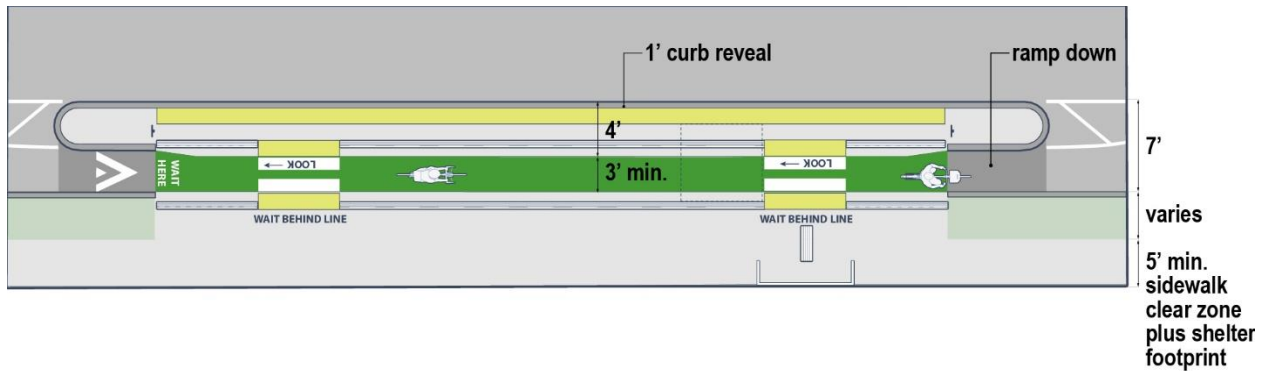

4.6.3.2 Raised Bike Lanes with Shared Boarding and Alighting Area

Similar to a side path design, where bus passengers frequently board and alight from the path, this design requires the bike lane to serve as the boarding and alighting area (**Figure 4-8** and **Figure 4-10**). When buses are not present, this design may improve the comfort of bicyclists along the corridor; however, the bus stop design necessitates that passengers boarding and alighting the bus use the raised bike lane as a part of the platform. It is generally not desirable for bus patrons to cross an active travel lane (the bike lane) in order to access the bus. The design creates conflict points, requiring the boarding and alighting area to overlap with the bike lane (a situation not explicitly identified in PROWAG). As such, the bike lane within the bus bulb is a shared transit platform, which must comply with the boarding and alighting accessibility guidelines (see **Accessibility Considerations**).

To further manage the risks of potential conflicts when installing a shared transit platform, the design should install the following:

- Tactile detectable warning surfaces separating the shared transit platform area from the sidewalk (See **Figure 4-8**) with railing at both ends of the shared transit platform area (See picture on right of **Figure 4-10**) to further clarify boundaries and prevent conflicts.
- “DO NOT WAIT IN BIKE LANE” markings at the edge of the shared transit platform area separating the shared transit platform area from the sidewalk to discourage pedestrians from standing in the shared transit platform area when pedestrians are not boarding or alighting a bus.
- Green (4-foot) and White (2-foot) bands throughout the length of the shared transit platform area to highlight the shared zone (See picture on right of **Figure 4-10**).
- Advanced warning signs and yield markings for bicyclists, and
- Tactile warnings strips at the top of the bicycle ramp to warn bicyclists to yield to pedestrians (See **Figure 4-8**).

See **LADOT Standard Detail S-523.0** for details.

To ensure that the boarding area is ADA Compliant, the shared boarding islands should be as flush as possible with the adjoining sidewalk. The boarding area slope requirements are shown in **Sheets 11 and 12 of the Supplemental Design Guide Detail 400**.

Due to concerns with this operation, it is possible that projects seeking federal funding that propose this design may not be approved. These designs should be vetted as early as possible in the process with FHWA and CalTrans, especially if Federal Funding is involved in the project.

Figure 4-8 - Raised Bike Lane Example (Toronto, Ontario)



4.6.3.3 Standard Bicycle Lane

Typically, when a Class IV protected bike lane is located along the corridor, the separation between the motorist lane and the bike lane will need to be terminated prior to the bus stop, so that the bus can pull to the curb for passenger boarding and alighting. In these instances, broken lane lines and pavement markings should be used to ensure that both bus operators and bicyclists should expect buses to fully encroach into the bike lane (see **Figure 4-9**). Bicyclists will have to stop and wait in the bike lane when buses are at the stop or bicyclists will have to merge into traffic to bypass the stopped bus.

Figure 4-9 - Typical Curbside Bus Turnout with Class IV Protected Bike Lane

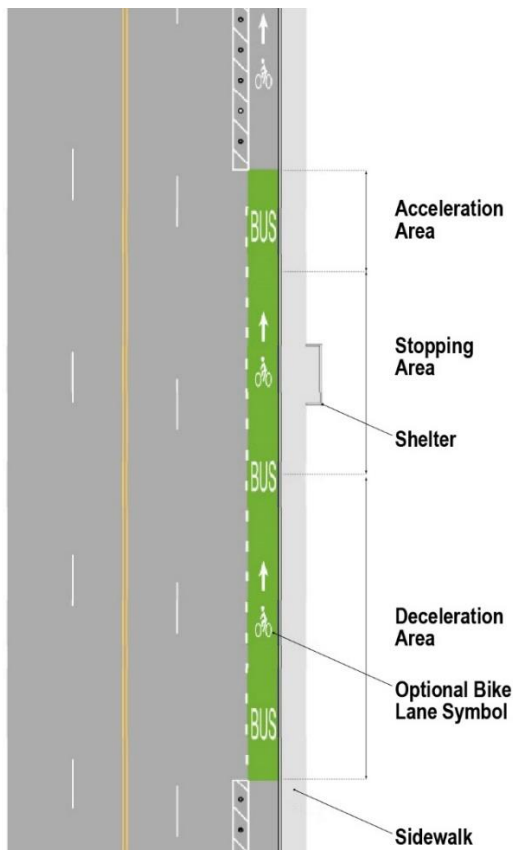

4.7 INTERIM RAISED BUS BULB WITH BIKE LANE

Raised Bike Lanes at Bus Bulbs can be built with modular materials (recycled rubber or plastic materials) when cost is an issue and/or installation is meant to be interim or temporary. The materials and design must be approved by the City Engineer before installation. The bicycle lane may pass behind the bus boarding and alighting area or be routed over it (**Figure 4-10**). A revocable permit (R-Permit) will be required to install a modular bus bulb type if proposed by a private party not authorized to occupy the right-of-way.

To ensure that the boarding area is ADA Compliant the modular shared boarding islands should be as flush as possible with the adjoining sidewalk. Any modular platform installed should be considered temporary in nature to either test suitability for a proposed location or until an installation is implemented with permanent materials. When resources are available to install a permanent shared boarding island, it should be installed so that it is completely flush with the sidewalk. The boarding area slope requirements shown are shown in **Sheet 11 & 12 of the Supplemental Design Guide Detail 400**.

Figure 4-10 - Modular Raised Bus Bulb with Bike Lane



**Modular Raised Bus Bulb with
Street Level Bike Lane**

Photo: City of Oakland

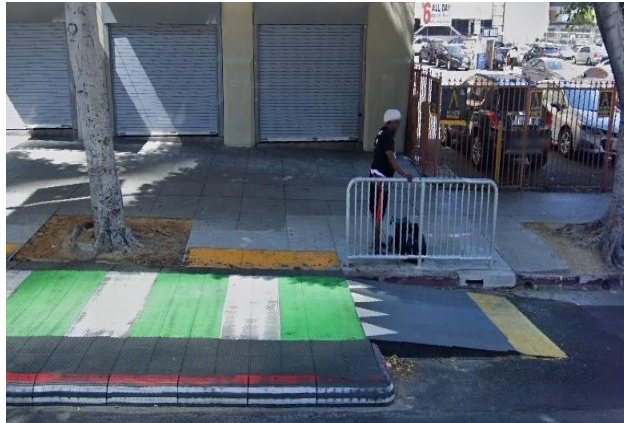

**Modular Raised Bus Bulb and
Raised Bike Lane**

Photo: Streetsblog LA

4.8 ACCESSIBILITY CONSIDERATIONS

All pedestrian routes are required to meet accessibility standards and be in conformance to the most current ADA or CBC requirement which are periodically updated. Where conflicts exist, the ADA and CBC shall supersede this guidance.

4.8.1 Accessibility

All bus platforms must provide the following:

- Landing Area – shall be a minimum width of 5 feet along the curb, and a minimum depth of 8 feet perpendicular to the curb (inclusive of the curb width).
- Perpendicular to the street, the boarding and alighting area shall be a firm, stable surface, with a maximum 2% cross slope. Parallel to the street, the landing area shall match the street running slope to the maximum extent practicable.
- A curb reveal (height from surface of the street to the top of the curb) between 4 and 8 inches is required to maximize the ability of the vehicle to deploy accessibility ramps to the boarding and alighting area
- Where curb reveal exceeds 8 inches along the back side of the passenger boarding and alighting area due to a streets steep cross slope, a railing will be required to prevent people from falling from the boarding and alighting area into the bicycle lane or adjacent sidewalk
- Accessible routes must be provided between the sidewalk, crosswalk, boarding and alighting zones and bus shelters. The accessible route must be clear of vertical obstructions. The accessible route must be a minimum width of 48 inches with a 60-inch width preferred (see

- **Figure 4-11).** The accessible route may be inclusive of front and rear boarding and alighting areas.

When, because of right-of-way restrictions, natural barriers or other existing conditions, the City determines that compliance with the 48-inch clear sidewalk width would create an unreasonable hardship, the clear width may be reduced to 36 inches upon issuance of a design exception approved by the City Engineer. In addition to the minimum requirements stated in the Design Exception process, the report must include:

- The proposed accessible route including all physical constraints which are impacting the accessible route dimensions
- the anticipated average daily and average peak daily and hourly people boarding and alighting at the stop
- frequency of transit access identifying all transit providers and routes serviced at the location

An accessible route connecting the boarding and alighting area to the shelter (if used) and the adjacent pedestrian facility is required for all bus bulb configurations. When bus bulbs or floating bus stops are located at an intersection, key design considerations are the effective turning radius of the design vehicle, the placement of the pedestrian curb ramps, and the crosswalks. It is important to design the accessible route to ensure visually impaired pedestrians do not inadvertently walk into moving travel lanes. The minimum width of the island may need to be increased to accommodate railings where the minimum 5' x 8' boarding and alighting area cannot be accommodated. Bus shelters should be chosen and placed to ensure the minimum 4' accessible route is provided between the shelter and the boarding and alighting area (see **Figure 4-11**).

4.8.2 Curb Ramps

Type I bus bulbs attached to sidewalks should be able to provide an accessible route from the sidewalk to the bus bulb without the need of a curb ramp. In some cases, a planter strip may need to be converted to a sidewalk to complete the accessible route. The curb extension portion of the bus bulb should provide two directional ramps as shown in **Figure 4-3**.

Type I bus bulbs which include a sidewalk level bike lane will require detectable warnings to denote pedestrian crossings of the bike lane area as shown in **Figure 4-4**. A minimum of one pedestrian crossing is preferred, but two are preferable to allow front and rear access.

Type II bus bulbs will require a curb ramp to access the floating bus bulb from the sidewalk where street level or intermediate level protected bike lanes are proposed. For these conditions at least one curb ramp located closest to the nearest street intersection is required as shown in **Figure 4-5**. Where space allows, two curb ramps are preferable to allow front and rear access as shown in **Figure 4-4**.

Type II bus bulbs which do not include separated bike lanes will require either curb ramps to access the bus bulb as previously described or a sidewalk culvert with a lid that conforms to accessibility standards to allow people to cross. The culvert should be constructed in accordance to guidance in Drainage and Grading.

Figure 4-11 - Accessible Route to/from Boarding and Alighting Area to a Shelter

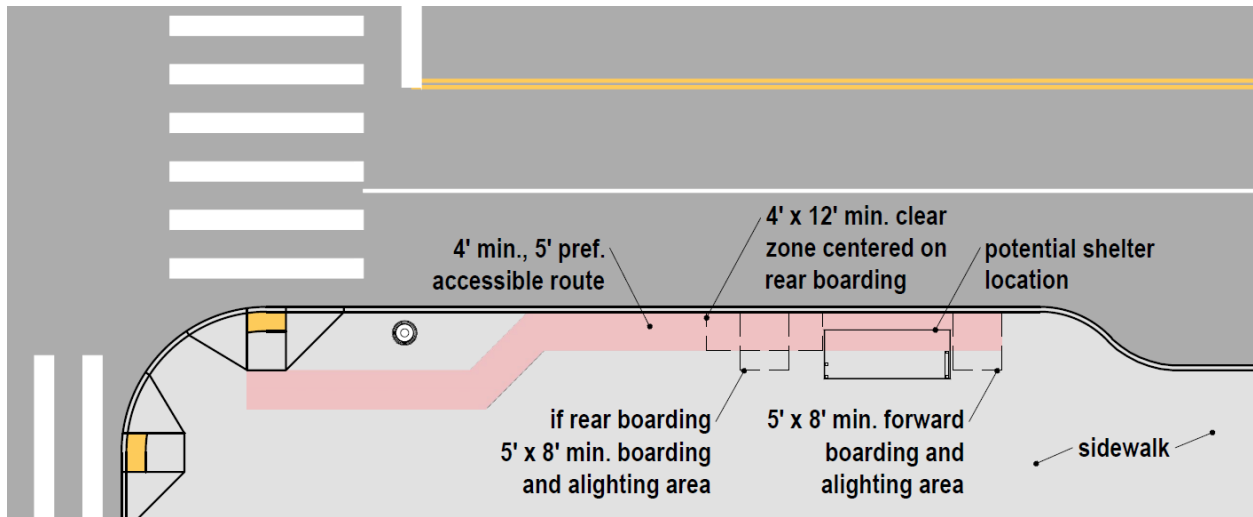

**Note that the accessible boarding and alighting area(s) must be located in the location that aligns with the accessible door(s) of the bus. Some buses have rear door boarding and alighting.*

At locations with a protected bike lane, it is preferable for the bus bulb to include a corner island to create a protected intersection. This is typically only feasible where directional curb ramps are provided at the intersection and the **Corner Radius** needs of the design vehicle allows sufficient space to construct an island. This creates a **Crossing Island** for pedestrians crossing the road as part of the bus bulb. This eliminates the need for an additional curb ramp to connect the sidewalk to the bus bulb (Alternative 1 in **Figure 4-12**). A parallel pedestrian ramp connects bus patrons to the crosswalk. The bike lane may be at street level, intermediate level, or sidewalk level to ensure an accessible route is provided (see **Supplemental Design Guide Detail 400**).

Where a corner island is not feasible due to turning vehicle design radius needs, it will be necessary to direct pedestrians to the sidewalk with a separate curb ramp. This will require installation of a new curb ramp within the sidewalk (see **Supplemental Design Guide Detail 400**). Alternative 2 in **Figure 4-12** shows this design with a street level protected bike lane. The bike lane may also be raised in this design as shown in Alternative 3.

Where replacement of directional curb ramps at intersection corners is not feasible, it may be necessary to direct pedestrians to the sidewalk with a separate curb ramp (see **Supplemental Design Guide Detail 400**). This will require installation of a new curb ramp within the sidewalk as shown in Alternative 2 (in **Figure 4-12**) or to consider a raised bicycle lane behind the boarding and alighting area shown as Alternative 3 (in **Figure 4-12**).

Figure 4-12 Curb Ramp Layout Alternatives with Floating Bus Stop

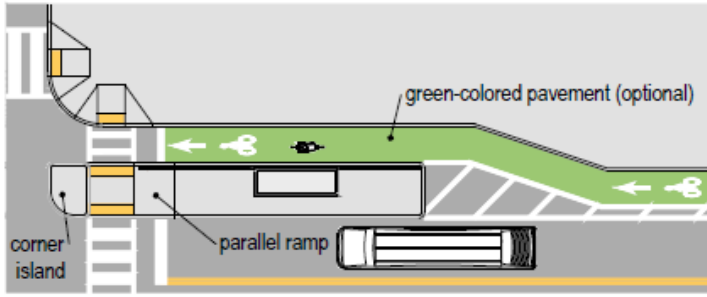

ALTERNATIVE 1

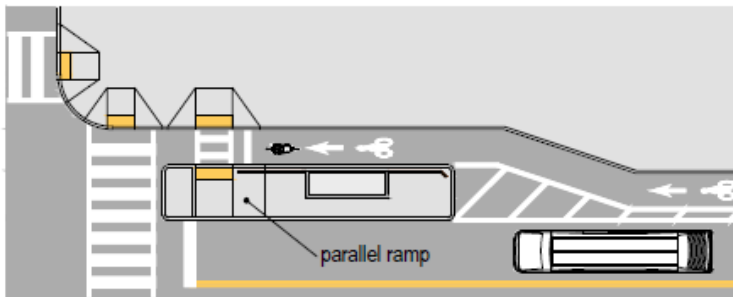

ALTERNATIVE 2

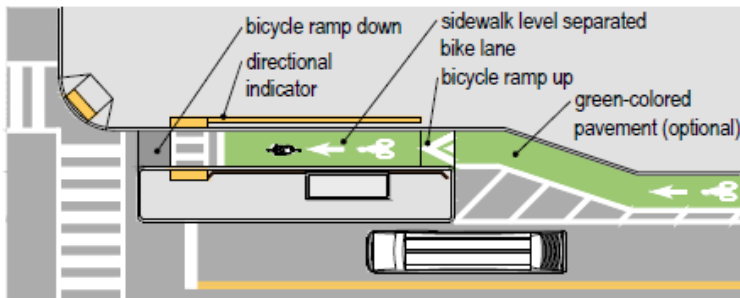

ALTERNATIVE 3

5 CROSSING ISLAND

5.1 OVERVIEW

Crossing islands provide protected space in the center of the street to facilitate pedestrian crossings, particularly when there are multiple lanes of traffic. Islands can simplify the crossing, by allowing pedestrians to focus on one direction of traffic at a time, which may be particularly useful at locations where gaps in motor vehicle traffic are limited, particularly when assessing a single crossing as one continuous movement across both directions of traffic. Crossing islands are also effective at slowing left turn traffic when located at intersections by reducing the effective turning radius. These design features are typically constructed with curbs but can be designated with flexible delineator posts and paint. These islands can also provide traffic calming by narrowing the street and creating edge friction.

Crossing islands are more typically provided at intersections, but they can also be implemented at mid-block locations where high pedestrian activity is observed or anticipated. The presence of the island provides motorists visual cues that people may be crossing at those locations. Crossing islands must be a minimum of 6 feet in width to be considered a pedestrian refuge.

Figure 5-1 Examples of Crossing Islands



Typical Mid-block Crossing Island



Intersection Crossing Island

5.2 DEFINITIONS

Crossing Island: An island which surrounds a crosswalk or bicycle crossing that aids and protects pedestrians and bicyclists who cross the roadway. They may be located at intersections or midblock locations and may be part of a larger median.

5.3 GENERAL BENEFITS AND DESIGN CONSIDERATIONS

The following are general benefits and considerations associated with raised crossing islands:

5.3.1 Benefits

- Are a proven countermeasure to improve pedestrian safety⁵.
- Increases visibility of pedestrians crossing where vegetation or plantings are maintained to preserve sight lines between 36" to 80" of vertical elevation.
- Provides pedestrian refuge between two directions of traffic, which benefits slower walking pedestrians, seniors, children, or those with walking impairments; additionally, crossing in two stages may improve motorist yielding at uncontrolled locations.
- Can reduce pedestrian exposure to motor vehicles by shortening crossing distances.
- Can be used when curb extensions are not feasible due to drainage challenges.
- Creates motorist edge friction which may decrease vehicle speeds.
- Reduces left turn pedestrian crash risk at intersections when designed to decrease left turning motor vehicle speed near crosswalks⁶.
- Provides a physical separation for opposing traffic directions. Provides landscaping opportunities but sight lines must be maintained for safety.
- Provides opportunity for in-street placement of passive or active warning devices improving visibility of the device to approaching motorists.
- Provides opportunity for in-street placement of signal equipment in the median island, thereby potentially reducing the need for large poles and mast arms for a full signal.

5.3.2 Design Considerations

- Requires adjustments to existing utility access points within the median footprint, if present.
- Decreases the possibility of encroachment depending on the street characteristics, which may affect the ability for certain vehicles to make turns.
- Allocates street space which could preclude the ability to provide left turn lanes or bicycle facilities through an intersection or area with no on-street parking.
- At locations with parking and right-turn lanes, an option is to restrict parking or to eliminate right turn lanes to allow for the preservation of left turn lanes (where necessary for safety and traffic operations) or bicycle facilities (**Figure 5-2**).
- A minimal elevation change for pedestrians within the crossing island is preferable to decrease the effort required for people with disabilities to navigate curb ramps, while ensuring a level surface free from water pooling within the refuge (see Accessibility section).
- These should not be used as a strategy at signalized intersections to create multi-stage crossings unless approved by the City.
- At locations where, multi-stage crossings are required or where people frequently queue within the crossing island, it should be designed to maximize the queuing space with sufficient median width and end protection to buffer passing traffic.

⁵ <https://safety.fhwa.dot.gov/provencountermeasures/>

⁶ <https://www1.nyc.gov/html/dot/html/pedestrians/left-turn-traffic-calming.shtml>

Figure 5-2 Example Use of Chicane and Parking Restriction to Place Crossing Islands

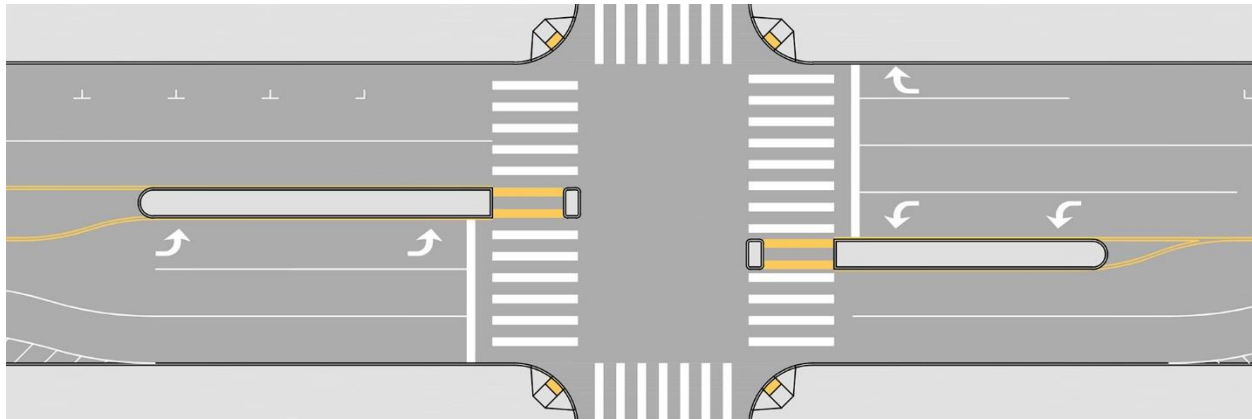

5.4 APPLICATIONS

Raised crossing islands can be installed on any street which have 2 or more travel lanes (1 per direction), but should be prioritized for implementation at intersections and midblock locations with the following conditions:

- At signalized and unsignalized locations with higher pedestrian volumes such as locations near schools, hospitals, senior housing, community centers, parks, transit stations, and shared use trail crossings
- At marked, uncontrolled crossings where the following motor vehicle traffic characteristics⁷ exist:
 - ≥ 35 mph posted or operating speed
 - $\geq 9,000$ Average Annual Daily Traffic (AADT),
 - or ≥ 3 lanes⁸;

5.4.1 Intersections

- Where curb extensions are desired but may not be feasible due to drainage challenges
- Locations where the spacing between dedicated pedestrian crossings on a block exceeds 300 feet
- At locations with a planned or existing bike route, or local street on a Neighborhood Enhanced Network (NEN) crosses a major avenue or boulevard where it is desired to improve bicyclist crossing safety
- Locations where it is desired to slow left turning traffic and/or improve pedestrian or bicyclist safety
- At signalized locations where it is desirable to provide refuge for people that cannot clear the intersection during a single signal phase due to slower walking speeds

⁷ at locations which exceed these thresholds, additional crossing treatments (e.g., Rectangular Rapid Flashing Beacons (RRFBs)) may improve motorist's yielding and can be used in conjunction with raised median islands

⁸ FHWA's *Guide for Improving Pedestrian Safety at Uncontrolled Crossing Locations*, July 2018

- At signalized locations where people routinely begin crossing the street late in the cycle (due to motorists failing to yield to allow them to begin the crossing) resulting in pedestrians being within the street when the phase ends

5.4.2 At mid-block crossings

- Locations where the spacing between dedicated pedestrian crossings on a block exceeds 300 feet
- Shared use path crossings

At curved or hilly roadways, special consideration should be made to ensure the mid-block refuge island has adequate stopping sight distance. If sight distance is insufficient, other traffic calming measures should be considered.

5.5 DESIGN GUIDANCE

Crossing islands are typically constructed with permanent materials, such as concrete, but may be installed with temporary materials which provide a vertical separation to traffic such as flexible delineators, bollards, planters, or temporary curbing as well. Decorative treatments such as stamped or colored concrete or landscaping may be used within the island to supplement the vertical materials and further define the pedestrian space.

5.5.1 Constructed Medians

Crossing islands must be at least 6-feet wide to be considered a pedestrian refuge (see **Accessibility Considerations**). Where pedestrian volumes are high, where people with mobility devices cross, or where bicyclists will cross (e.g., trail crossings, NEN), depths between 8 and 10 feet are preferred. At widths between 4 feet and 6 feet there are still safety benefits to providing a constructed raised divisional island to slow left-turning motorists, however, they do not provide refuge. At locations where, median opening is greater than 20 feet in width, a bollard may be considered to prevent vehicles from encroaching into the pedestrian space.

When there is no room for an island with a minimum width of 4 feet, a hardened centerline may be provided to slow left turning vehicles (see **Figure 5-3** and **Hardened Centerlines**). **Supplemental Design Guide Detail 500** and **LADOT Standard Plan S-525.0** provide details for small refuge islands.

It is preferable for the opening of the island (the crossing island cut through) to match the crosswalk width to maximize space for queuing within the refuge. At locations where this is not desirable, the minimum opening should be at least 8 feet wide.

Island “noses” should be constructed perpendicular to the crosswalk, pointed toward the center of the intersection. The island nose is effective at establishing the pedestrian waiting area within the crossing island improving comfort for people waiting within the median. It also discourages motorists from encroaching into the pedestrian queuing space, while simultaneously slowing left-turn motorists across the crosswalk. A minimum 4-foot width nose is preferred. Island noses shall not extend beyond the curb line prolongation of the cross street unless shadowed by a parking lane.

When crossing islands are installed at locations with existing diagonal curb ramps, it may not be possible to construct a nose that is outside of the path of a perpendicular travel lane or the path of some left-turning motor vehicles. In these locations, a nose (with a minimum width of 2-feet) that is recessed into

the crosswalk with a mountable nose can help control the left-turning speed of the most common vehicle, while accommodating the design vehicle (see **Sheet 2 of Supplemental Design Guide Detail 500**). To minimize out of direction travel, the encroachment should be limited to a line connecting the closest curb ramp corners on opposite ends of the crosswalk. Where a nose cannot fit, a mountable curb placed at the end of the crosswalk may be used (**Figure 5-4**).

At signalized locations where, larger vehicles will frequently track over the mountable nose, or a mountable curb into the refuge space, multi-stage crossings and pedestrian refuge should not be used. The treatment's sole benefit will be to slow left turning vehicle speeds to improve the safety of pedestrians crossing the entire street concurrently with left turning traffic.

At mid-block locations, the nose should be constructed at either end of the crosswalk with a minimum width of 8 feet.

Figure 5-3 Typical Crossing Island Layout at an Intersection

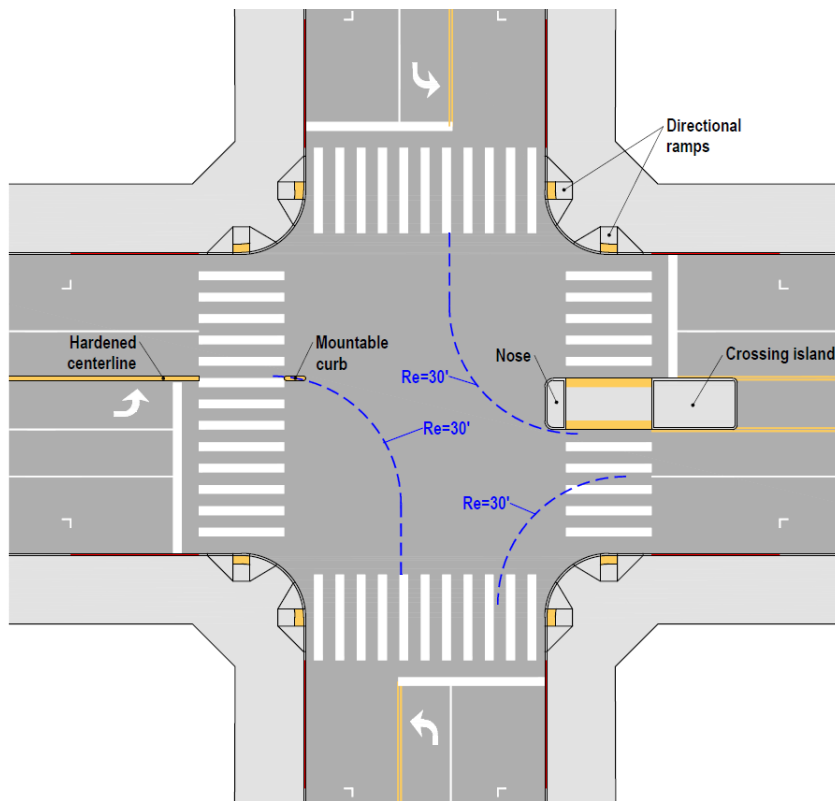
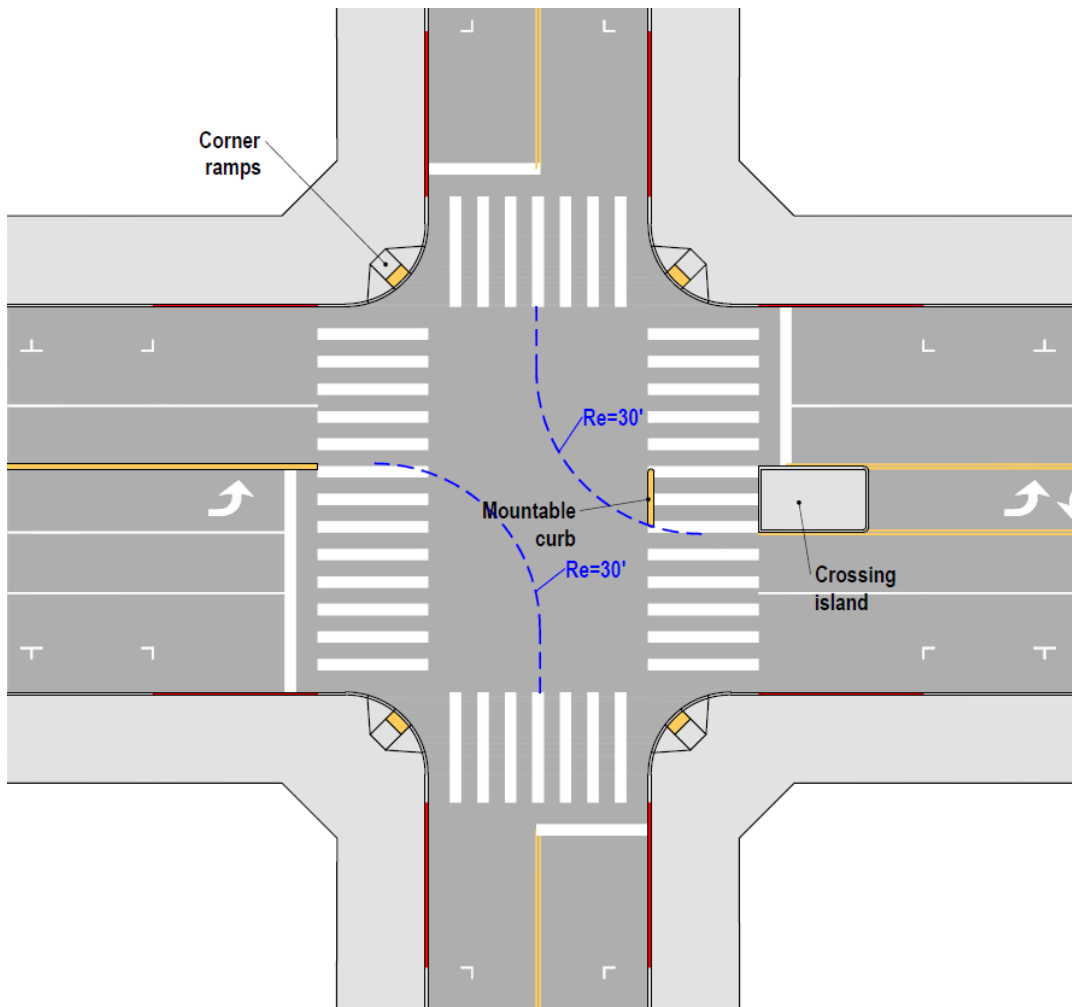
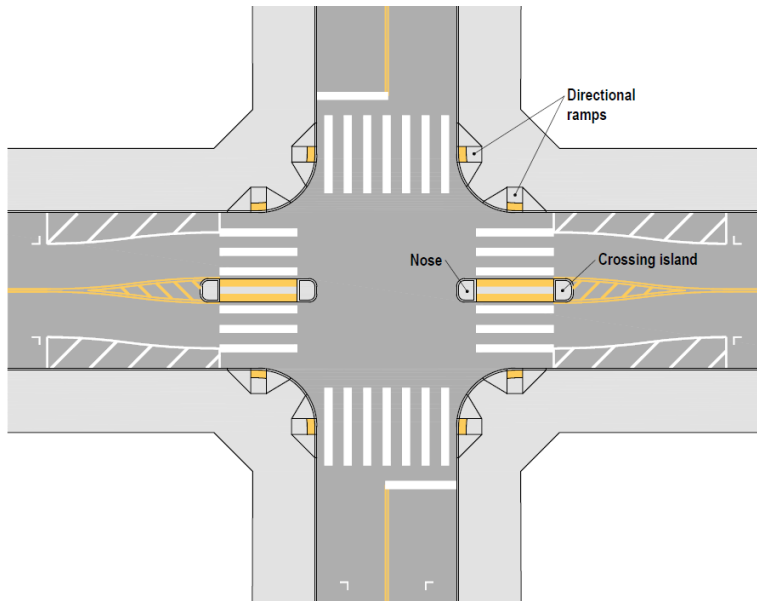

Figure 5-4 Typical Crossing Island with Diagonal Ramps



Crossing islands can be used in conjunction with other traffic calming elements such as chicanes, speed humps, curb extensions, etc. to increase traffic calming effectiveness. **Figure 5-5** illustrates a crossing island design that restricts parking on the approach to create space for the crossing island. By removing parking approaching the intersection, a chicane in the travel lane is established, which may slow motorists at the intersection. If landscaping is provided within the crossing island, it should be maintained to comply with intersection sight distance requirements as discussed in **Section 5.7**.

Figure 5-5 Crossing Island Providing Chicane Traffic Effect



5.5.2 Hardened Centerlines

A hardened centerline is a painted centerline supplemented by flexible delineators, mountable curb, rubber curb, concrete curb, In-Street Pedestrian Crossing signs (R1-6), or a combination of these treatments. Hardened centerlines should be considered where insufficient space is available to provide a 6-foot minimum width pedestrian crossing island or narrower divisional island, as they have been found to reduce the speed of left-turning motorists by reducing the effective turning radius. They can be combined with **Curb Extensions** (to reduce inappropriate motorist encroachments into crosswalks and reduce turning speeds).

Figure 5-6 Examples of Hardened Centerlines



Flexible Delineator Hardened Centerline



Mountable Hardened Centerline (Credit: Tom Bertulis)

Figure 5-7 Typical One-way Street Layout with Crossing Island and Hardened Centerline

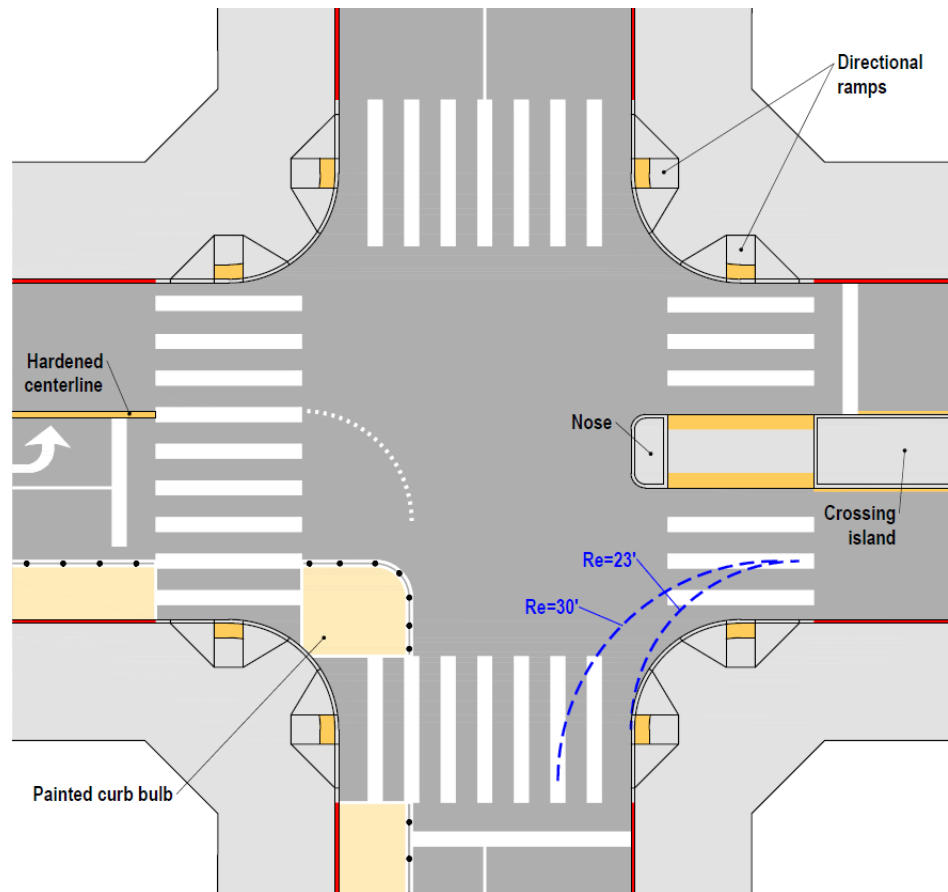

5.5.3 Pavement Markings and Signs

At uncontrolled crossings, the use of pavement markings and signs should follow **LADOT Standard Drawing S-481.0**. At multi-lane crossings, a Rectangular Rapid Flashing Beacon (RRFB) or the In-Street Pedestrian Crossing sign (R1-6) may be used as supplemental treatments (in a gateway configuration at the crossing⁹) to increase motorist yielding rates.

Advanced yield lines and additional traffic control treatments should be considered, per **LADOT Marked Uncontrolled Crosswalk Guidelines**, where crossing islands are provided. If Rectangular Rapid Flashing Beacons (RRFBs) are used, they shall follow LADOT guidelines for installation and operation and allow actuation from within the refuge island. This may require the installation of 2 additional pedestrian push buttons at locations where only 2 RRFBs are provided.

5.6 ACCESSIBILITY CONSIDERATIONS

5.6.1 Design Considerations

Crossing islands shall be a minimum of 6 feet in width to be considered a pedestrian refuge to meet accessibility requirements. To maximize accessibility for people with mobility challenges, the cut

⁹ https://www.michigan.gov/documents/mdot/Spotlight_SPR_1638_1643_560921_7.pdf

through opening of the refuge area should match the width of the crosswalk. The landing should be level in all directions (to a maximum cross slope of 2%), and there should be minimal elevation change above the street to minimize or eliminate the need for curb ramps. Where the refuge area is elevated above the roadway, additional width is needed to provide space for a curb ramp and a level landing at the top.

Detectable warning surfaces are required at each entrance into the street to alert visually impaired pedestrians that they are entering the street when the crossing island is 6 feet or more in width. The detectable warning shall be placed at the edges of the pedestrian island or cut-through median and shall be separated by 24 inches minimum of walking surface without detectable warnings.

5.6.2 Signalized Intersection Considerations

It is preferable for crossings to allow for slower pedestrians to cross the entire street in one movement at signalized intersections. However, pedestrian push buttons should be provided in the median to ensure that pedestrians who do not cross the entire street are able to actuate the signal from the island to complete their crossing on the next cycle. At unique signalized locations where pedestrians are expected to cross in two or more stages by waiting in crossing islands, the crossing island shall be at least 6 feet in width and provide pedestrian push buttons to place a call to cross.

On divided streets where there is sufficient pedestrian clearance time to allow pedestrians to cross in one phase, median pedestrian heads shall not be provided. On divided streets where it is not feasible to allow pedestrians to cross in one phase, pedestrian heads in the median are required.

Where islands are greater than 10 feet in width and median pedestrian signal heads are provided, the crosswalks across each street may be offset or aligned to create an angle point at the median island so as to provide a visual cue for pedestrians to wait in the median and finish crossing on the next cycle.

At the street corners, pedestrian push buttons are to be located within 5 feet of the crosswalk, per LADOT Std. Drawing. S-101.0. Within a median, pedestrian push buttons must be within 18 inches of the curb to ensure they meet accessibility requirements.

5.7 MAINTENANCE CONSIDERATIONS

The median island space outside of the pedestrian crossing and queuing zone may be landscaped or hardscaped. Where plantings are used, they should be native plants or drought resistant species. Species should be planted to not encroach onto travel lanes or reduce motorist and pedestrian visibility.

Planting, trees, street furniture, signs, or other obstructions within the crossing island must not inhibit intersection sight distances by maintaining a clear zone of visibility between 36 inches to 80 inches high from the ground. Trees planted in a crossing island are not considered intersection sight distance obstructions if they are routinely trimmed to ensure a clear zone of visibility and will mature to a clearance of 14 feet on street side and 8 feet on sidewalk side.

For ease of construction, it may be desired to construct the refuge area out of concrete. Concrete generally offers greater control over the finished surface and grade. It can also reduce the number of pavement joints. The refuge area will require regular sweeping to dispose of dirt and debris.

6 RAISED CROSSWALK

6.1 OVERVIEW

A raised crosswalk can slow turning (**Figure 6-1**) or approaching traffic (**Figure 6-2**), help achieve accessible crossings, and increase the conspicuity of crosswalks.



**Figure 6-1 Example Side Street
Seattle, WA**



**Figure 6-2 Example Midblock
Washington DC**

6.2 DEFINITIONS

Raised crosswalks: A speed table elevated above the street which also includes a marked pedestrian crosswalk, bicycle lane crossing, or shared use path crossing spanning the entire width of the street.

6.3 GENERAL BENEFITS AND CONSIDERATIONS

A raised crosswalk has the following general safety benefits and operational or design considerations. In general, the benefits for pedestrian safety associated with raised crosswalks apply to bicyclists as well who may traverse them on sidewalks, shared use paths, sidepaths, or separated bike lanes.

6.3.1 Benefits

- Increases motorists yielding to pedestrians in crosswalks¹⁰.
- Reduced motorist crashes with bicyclists operating in protected bike lanes up to 50% at unsignalized locations with raised side-street crossings¹¹.
- Provides accessible and convenient crossings for pedestrians, especially those with mobility and visual impairments, by minimizing elevation changes at curb ramps; it may be particularly beneficial at locations where it is difficult to construct curb ramps due to limited right-of-way.

¹⁰ Huang, H.F. and M.J. Cynecki. The Effects of Traffic Calming Measures on Pedestrian and Motorist Behavior. FHWA-RD-00-104. Federal Highway Administration. U.S. Department of Transportation, Washington, DC, 2001.

¹¹ Schepers, J.P., P. A. Kroeze, W. Sweers, and J.C. Wust. Road Factors and Bicycle-Motor Vehicle Crashes at Unsignalized Priority Intersections. Accident Analysis and Prevention, Vol. 43, 2011, pp. 853-861.

- Improves motorists' awareness of crosswalks and visibility of pedestrians, especially at midblock crosswalks.
- Supports traffic calming.
- Can eliminate water ponding and debris collection at the base of typical curb ramps and improve accessibility if designed properly (see **Section 6.5.4**).
- Crashed reductions associated with the installation of raised crosswalks will reduce emergency response needs.

6.3.2 Considerations

- In order to maximize raised crosswalk benefits, they can be implemented in conjunction with **Curb Extension** to decrease crossing distances and improve pedestrian visibility to motorists.
- Similar to Curb Extensions, raised crosswalks may create a new low spot due to the existing cross slope and longitudinal slope of one, or both intersecting streets. For this reason, implementing a raised crosswalk at the same location as a curb extension should be considered.
- The use of raised crosswalks on boulevards and arterial streets may be unexpected by motorists. Consider alternate designs if the raised crosswalk is not clearly visible to approaching motorists. LADOT will make the final determination of the potential for the crosswalk to be unexpected or not visible which may warrant advance warnings or the need to consider an alternative design.
- There is potential for some low wheel-base vehicles to bottom out on raised crosswalks over 3 to 4 inches in height. This is dependent upon the vehicle design, ramp length, crosswalk width, and street grade (see **Section 6.5.2.1**).
- Deviations from the raised crosswalk geometrics may dramatically reduce their effectiveness and safety. Raised crosswalk approaches that are too abrupt may cause rear-end crashes or cause bicyclists or motorcyclists to lose control. Conversely, a raised crosswalk that is too low may fail to reduce motorists' operating speeds.
- The design of the approach ramp can have a negative impact on ride quality for vehicles, motorcycles, and bicyclists if it is not built to create a smooth transition between the street surface and the ramp.
- The use of raised crosswalks with elevations below 3 inches and/or flatter approach ramps may reduce traffic calming benefits.
- Raised crosswalks may not be feasible on streets with grades due to the requirement to provide a level landing for pedestrians across the crosswalk
- Installations at locations where horizontal or vertical curves limit the sight distance between the raised crosswalk and approaching motorists may require additional advance warning treatments
- May require changes to drainage infrastructure to ensure that the water flow lines are properly accommodated.
- At signalized intersection locations where the limit line is set back to accommodate the raised crosswalk, existing traffic loops or videos will require adjustment.
- Raised crosswalks may increase emergency response times from 1.8 to 10 seconds¹².
- Traffic signal timing and posted speeds may need to be reassessed at locations where the installation of raised crosswalks results in slower operating speeds.

¹² Institute of Transportation Engineers. Guidelines for the Design and Application of Speed Humps and Speed Tables. Washington, DC. 2011. Pp. 11.

There are additional design considerations which are specific to drainage, accessibility, and maintenance discussed in their respective sections on those topics.

6.4 APPLICATIONS

Raised crosswalks may be appropriate at controlled or uncontrolled crossings to address safety issues related to motorist operating speeds and failure to yield. All locations of proposed raised crosswalks require LADOT approval. In particular, they may be beneficial at the following locations:

- Channelized right turns (see **Figure 6-5**) or roundabouts where motorists are expected to yield to pedestrians or bicyclists within the crosswalk
- Intersection or midblock locations which have direct access to schools, hospitals, senior housing, community centers, parks, transit stations, shared use trail crossings, and other pedestrian-heavy destinations (see **Figure 6-2**)
- Side street crossings (see **Figure 6-1** and **Figure 6-4**), parallel to arterial and collector streets where it is desired to slow the speeds of left or right turning traffic to improve yielding to pedestrians and bicyclists; (see **Figure 6-6**).
- Where there are poor pedestrian or bicyclist visibility issues resulting in low rates of motorist yielding, or a pattern of collisions between pedestrians and motorists
- At locations where it is desired to improve the safety and prioritize the movement of bicyclists or pedestrians operating on shared use paths, separated bike lanes, or sidewalks

Figure 6-3 School Zone Raised Crosswalks on Avenue II

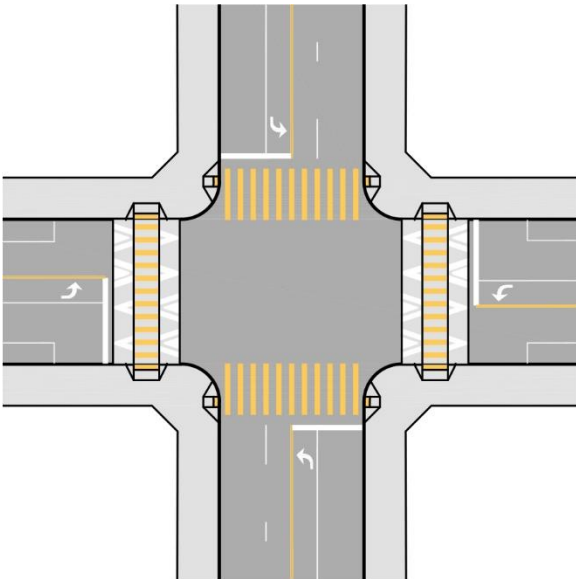

Figure 6-4 Raised Crosswalks on Side Streets

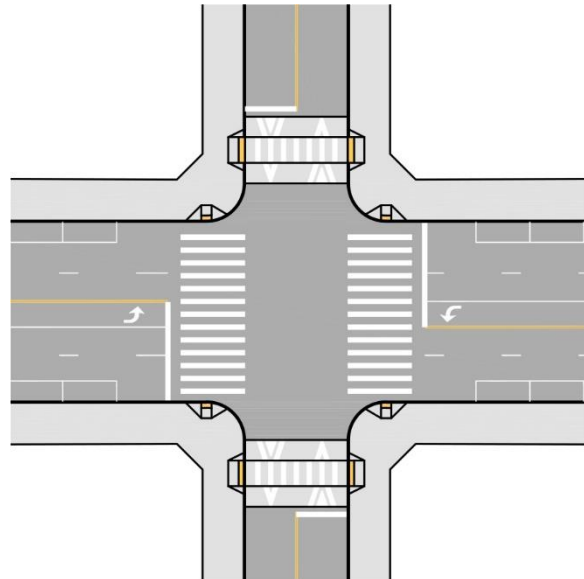

Figure 6-5 Raised Crosswalk at Channelized Right Turn

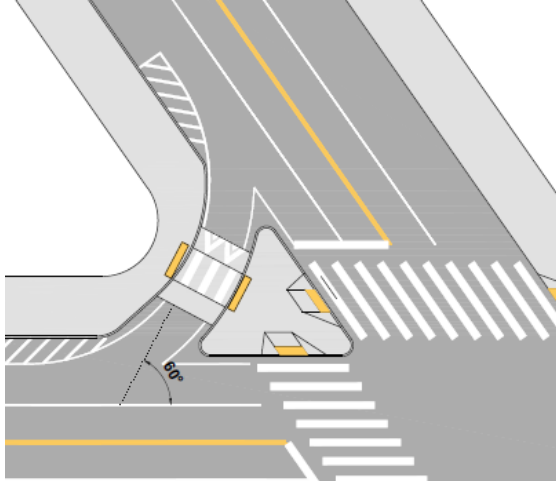
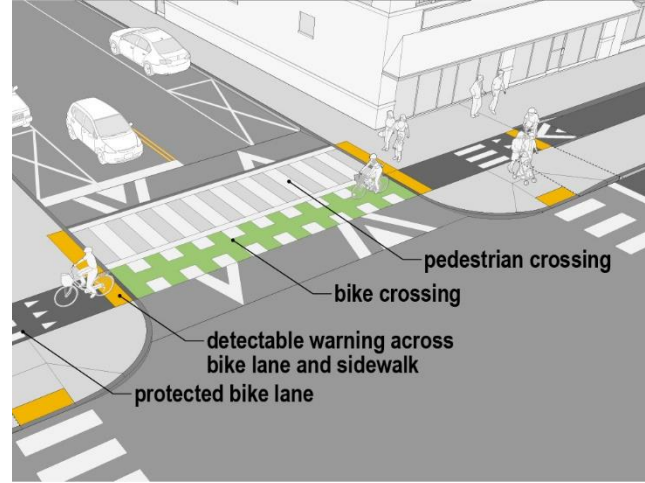

Figure 6-6 Raised Crosswalk with Class IV Bike Lane



Raised crosswalks may only be installed on streets which meet the following traffic conditions or street characteristics based on FHWA¹³, ITE¹⁴, and NACTO¹⁵ recommendations:

- In general, streets with longitudinal slopes require careful consideration of grade breaks, approach ramp design, and crosswalk tops. Raised crosswalks may not be desirable on streets with the following slopes approaching the crosswalk (see **Section 6.5.2.2**):
 - Uncontrolled and signalized approaches with slopes more than 4%
 - Stop controlled approaches with slopes more than 8%
- Posted speeds \leq 35 mph unless it is desired to lower the 85th percentile operating speed to 35 mph or less on streets posted at 40 mph or more to improve safety
- No more than 2 lanes of through traffic per direction (4 total for undivided streets);
- Where streets are “divided” by a continuous center turn lane or a dedicated turn lane – a raised median should be considered to provide refuge for crossing pedestrians
- Traffic volume < 20,000 vehicles per day with:
 - < 5% of total daily traffic volume consisting of heavy vehicles
 - Transit operating with headways of 15 minutes or more
- Not a designated emergency response or truck route
- There is sufficient motorist sight stopping distance to the raised crosswalk
- Midblock raised crosswalks shall be more than 20 feet from a driveway or 150 feet from an adjacent intersection, or other traffic calming device
- Side street raised crosswalks are preferably located within 30 feet of an adjacent intersection, but not more than 50 feet from it

A design exception approved by the City Engineer will be required for installation of a raised crosswalk on streets which do not meet these thresholds or on streets classified as arterials.

¹³ https://safety.fhwa.dot.gov/speedmgt/ePrimer_modules/module3pt2.cfm

¹⁴ <https://www.ite.org/pub/?id=2c3e7d2b%2D0d3a%2D93b9%2Daf9d%2D99dce352e79d>

¹⁵ <https://nacto.org/publication/urban-street-design-guide/street-design-elements/vertical-speed-control-elements/speed-table/>

In addition to the minimum requirements stated in the Design Exception process, the report must include:

- Street classification and use
- Horizontal curve distance and vertical design analysis showing vehicles will not bottom out traversing the crossing and noting the types of vehicles that are not likely to clear the raised crosswalk
- Existing stormwater flow and all necessary proposed mitigations to conditions which may result in ponding or flow re-routing
- Speed limit and the operating or running speed
- Traffic volumes in relation to the installation of speed humps including the total volume of traffic, the presence of cut-through traffic, and the traffic mix
- Emergency vehicle response time
- Study of expected long wheel-base vehicles or other special types of vehicles (i.e. school buses, cargo, motorcycles, etc.)
- Environmental impacts on noise levels and emission of pollutants
- Study of documented and/or anticipated traffic crashes, type and severity, and spillover effect
- How raised crosswalks facilitate calming techniques for pedestrians and Bicyclists
- Review of ADA requirements of raised crosswalks for both pedestrians and drivers with disabilities
- Public Involvement and Company Support to increase awareness and atmosphere of acceptance and ownership of raised crosswalk
- Life cost cycle assessment of installation, maintenance, and possible removal if community does not support the raised crosswalk
- And any other deviations from the previously stated application and design factors

Raised crosswalks shall be constructed using concrete (see **Section 6.5.3.1**). A design exception approved by the City Engineer will be required to construct raised crosswalks from asphalt. Inspection and Maintenance agreements should be identified and included in the design exception report.

A revocable permit (R-Permit) will be required to install a raised crosswalk if proposed by a private party not authorized to occupy the right-of-way.

6.5 DESIGN GUIDANCE

The length of a raised crosswalk consists of the approach ramp, the crosswalk, and the departure ramp. The width is measured from curb to curb, perpendicular to the traveled street. The height is measured from the street surface to the top of the crossing. The raised crosswalk must slow all approaching traffic across its entire length. It must also provide an accessible crossing for all pedestrians, including people with disabilities across its width where a marked crosswalk is provided. These design criteria are impacted by longitudinal street slope, street crown and cross slopes, drainage flow patterns, and infrastructure.

6.5.1 Construction Tolerances and Quality Control

6.5.1.1 Construction Tolerances

Meeting construction tolerances is crucial for raised crosswalks to meet accessibility requirements and to ensure the raised crossing achieves the desired goal of traffic calming and improving pedestrian and bicyclist safety. Post construction inspection should confirm the ramp profiles and other geometric design elements were constructed properly. An initial construction tolerance of 1/8 to 1/4 inch is required for all vertical design dimensions. For asphalt raised crosswalks, a maximum additional deformation or settlement of 3/8 inch is acceptable after 6 months. When vertical settlement is likely, the initial design should compensate to ensure the final vertical height of the crosswalk is between 3 and 4 inches in height, therefore ensuring traffic calming and operational goals are achieved.

6.5.1.2 Inspection and Quality Control

Upon construction, the raised crosswalk should be inspected for all conformance tolerances (defined in **Section 6.5.1.1**). Elements which do not conform to the specifications or tolerances shall be repaired or replaced. Where raised crosswalks are installed with asphalt, they should be re-inspected at 30 days, and 90 days post construction to verify conditions have not changed. Any element which does not meet specifications or tolerances must be repaired or replaced. Raised crosswalks should be inspected periodically as part of routine pavement marking maintenance activities thereafter to ensure the pavement markings remain visible. See **Section 6.7** for additional discussion.

6.5.2 Geometry¹⁶

6.5.2.1 Crosswalk Height

An ideal raised crosswalk for pedestrians provides a relatively level surface along the entire length (see **Section 6.6** for accessibility requirements) and width that is flush with the adjacent sidewalk (see **Figure 6-1**). This may not be achievable where existing or desired curb reveal is more than four inches in height, since taller raised crossings can create operational problems for vehicles with low clearances.

Some low wheel-base vehicles may bottom out on raised crosswalks over 3 to 4 inches in height depending upon the vehicle design, ramp length, crosswalk width, and street grade. Locations along a vertical curve should be checked using a loaded lowboy trailer (5" ground clearance with 36' wheelbase)¹⁷ where those vehicles are likely to operate.

Higher raised crosswalks have shown greater effectiveness on speed reduction. **Table 6-1** provides recommended crosswalk heights to fit speed goals and placement contexts.

¹⁶ Values are based upon findings of two primary sources:

- ITE Guidelines for the Design and Application of Speed Humps and Table. Institute of Transportation Engineers. 2011.
- Weber, P., Braaksma, J. Institute of Transportation Engineers Journal. 2000I Pp. 30-34.

¹⁷ Eck, Ronald, Kang, K. Transportation Research Record, No. 1356, "Roadway Design Standards to Accommodate Low-Clearance Vehicles. 1992. Pp. 80-89.

Table 6-1 Crosswalk Geometric Characteristics and Desired Motorist Speed at Crossing

DESIRED MOTORIST SPEED	MAXIMUM TABLE HEIGHT	APPROPRIATE LOCATIONS	APPROPRIATE RAMP PROFILES	RAMP LENGTH (MIN) AND TARGET SLOPE
≤ 20 MPH	4.0 inches	Local Streets	All	6 Feet or 1:12
≤ 25 MPH	3.5 inches	All Streets <u>without</u> Designated Emergency Response, Truck or Frequent Transit Routes	Sinusoidal or Straight	6 Feet or 1:18
≤ 30 MPH	3 inches	Arterial or Collector Streets <u>without</u> Designated Emergency Response, Truck or Frequent Transit Routes	Sinusoidal or Straight	6 Feet or 1:24
≤ 35 MPH	3 inches	Arterial Streets <u>with</u> Designated Emergency Response, Truck or Frequent Transit Routes	Straight	9 Feet or 1:24

NOTE: The ramp length shall be a minimum of 6 feet in length; the target slope should be used to guide final grading decisions during design to understand the potential impact on motorist approach speeds. The final ramp slope will vary based on existing street slope conditions.

City Departments which may be impacted by these treatments, including the Fire Department for effects on response time, BSS and BOS in term of drainage facilities and maintenance, and any other Departments that may be impacted should approve prior to implementation of these treatments. This approval must be documented.

6.5.2.2 Approach and Departure Ramps

The approach ramp profile impacts the raised crosswalks ability to slow approaching traffic and the comfort of users traversing it. There are three ramp profiles which may be considered:

- **Straight profiles:** constant elevation change, can be harsh at the top for bicyclists and motorcyclists. These profiles reduce speeds the least.
- **Sinusoidal profiles:** changes elevation later in the ramp approach with a smooth approach, is the most comfortable for all vehicles to cross, particularly for bicyclists and motorcyclists. These profiles reduce speeds more than straight profiles, but less than parabolic profiles.
- **Parabolic profiles:** changes elevation early in the ramp approach with a harsher approach for all users. These profiles reduce speeds the most.

The straight profile is easiest to construct. The Sinusoidal and Parabolic profiles are harder to construct to specification. A field template should be used to ensure the dimensions are constructed within a reasonable tolerance. A default ramp length is 6 feet. Where larger vehicles such as WB-50s are likely, or where frequent buses are expected, the approach ramp width should be increased to 9 feet minimum.

See **Supplemental Design Guide Detail 600** for details on approach and departure profiles.

Raised crosswalks installed on streets with longitudinal slopes over 4 percent may result in the elimination of the approach ramp on the uphill side (see **Figure 6-7**). This situation is typical where side streets with steep slopes approach arterial or collector streets. The downhill side of the approach from the steeper local street would not require a ramp to the raised crosswalk. This approach typically does not require traffic calming as motorists will typically approach a “stop control” condition. When a street with steep slopes has a longitudinal slope away from the arterial or collector, it may not be feasible to

install a raised crossing, as the departure ramp may require extensive regrading of the street to match existing grade.

Figure 6-7 Raised Crosswalk on a Steep Street (Seattle, WA)



Where raised crossings are proposed at side streets, the grade break between the existing cross-slope of the arterial or collector and approach ramp slope of the raised crossing must be considered. Where raised crossings are proposed across a stop-controlled side street, the change in grade between the raised crossing ramp and the adjacent street slope should not exceed eight-percent (8%) change in grade.

When a raised crossing is proposed across a signal-controlled side street an 8% change in grade may be too excessive for drivers who arrive at the signal on green. In these instances, a 5% maximum change in grade should be provided between the ramp slope and adjacent street slope. If the change in grade would exceed these thresholds, a raised crossing may not be feasible.

At mid-block raised crossings, the grade break should be limited to 5%.

Designers should note that this approach may require additional adjustments to the gutter line to maintain positive drainage flow across the intersection (see **Section 6.5.4**).

The ramps of raised crosswalks constructed with asphalt can deform (in the direction of traffic flow) over time under heavy traffic conditions. The approach ramp can also be subject to raveling when constructed with asphalt. Raveling can be minimized by milling a minimum 18" long by 1" deep key across the full width of the ramp into the existing pavement surface as shown on **Supplemental Design Guide Detail 600**. Constructing the raised crosswalk with concrete or utilizing flush header curbs in conjunction with asphalt can reduce or eliminate the deformation of asphalt approach ramps. Concrete ramps should be constructed with a consistent full depth thickness throughout their length.

6.5.2.3 Crosswalk Plateau

The width of the top of raised crosswalk should not be less than 10 feet in width, and preferably match the width of the connecting sidewalk, shared use path, or combined sidewalk and separated bike lane. It

is acceptable to increase the width beyond the crosswalk width to help match grades on the intersecting street.

There is no maximum width of the crosswalk, but consideration should be given to installing raised intersections at locations where more than 3 approach legs are desired to be raised or where the crosswalk plateau exceeds 25 feet in width. The vast majority of vehicles have wheel-bases shorter than 25 feet; raised crosswalks with longer plateaus are likely to have diminished traffic calming effectiveness.

To provide an accessible route for people with disabilities¹⁸ the surface must be smooth, stable, and slip-resistant with a maximum cross slope of 2-percent perpendicular to the pedestrian path of travel in the crosswalk (along the longitudinal path of the street). On streets with longitudinal slopes greater than 5% it may not be feasible to construct a raised crosswalk to meet this specification.

The designer may choose to lower sidewalks or provide curb ramps to connect the sidewalk to a raised crosswalk constructed in locations with 8 to 9-inch height curb. A key consideration in the design of the raised crosswalk is accommodating drainage (see **Accessibility Considerations**). Similar to a Curb Extension, raised crosswalks may create a new low spot due to the existing cross slope and longitudinal slope of one, or both intersecting streets.

Section 6.5.4 discusses drainage design options to accommodate drainage flow along the existing gutter line, while still complying with accessibility requirements.

6.5.3 Pavement Materials, Markings & Signs

6.5.3.1 *Raised Crosswalk Materials*

Raised crosswalks should be constructed using concrete. The use of asphalt raised crosswalks requires a Design Exception approved by the City Engineer. As discussed in **Section 6.5.2.2.**, asphalt ramps can be subject to deformation caused by the impact of heavier vehicles over time at locations with higher volumes of traffic or more frequent heavier vehicle use.

It is preferable for the raised crosswalk to have a distinct appearance from the street to enhance its conspicuity to motorists and reduce a reliance upon pavement markings which are subject to wear. Aesthetic enhancements, such as decorative colors and/or textured materials, can be applied to the crosswalk area, but should be excluded from the approach ramps of the raised crosswalks. Aesthetic enhancements should not diminish the conspicuity of the approach ramp or pavement markings.

The structural pavement design of concrete raised crosswalks must be approved by BOE.

6.5.3.2 *Markings*

A Raised Crosswalk marking (Chevron III) shall be used to mark the approach and departure ramps for each lane of travel at all raised crosswalks (see **LADOT Standard Drawing S-483.1**).

Advance speed hump markings shall be placed 100 feet to 250 feet in advance of the raised crossing (**LADOT Standard Drawing S-483.1**) and/or be supplemented by a series of eight white, 12-inch

¹⁸ US Department of Justice. 2010 ADA Standards for Accessible Design. Section 206, Accessible Routes.

transverse lines that become longer and are spaced closer together as the vehicle approaches the raised crosswalk as detailed in the California MUTCD (see **Figure 3B-31 of the CA MUTCD**).

At channelized right turns, it may not be possible to use advanced pavement markings. At uncontrolled crossings, the use of pavement markings should follow **LADOT Standard Drawing S-494.1**.

The crosswalk marking width should match the width of the top of the raised crossing. Where a protected bike lane is located parallel with the pedestrian crossing, the bike lane may be marked with green pavement markings supplemented by white edge lines to differentiate the pedestrian and bicyclist crossing areas within the crossing.

6.5.3.3 Signs

At uncontrolled crossings, the placement of signs and pavement markings should follow **LADOT Standard Drawing S-481.0 and S-483.1**.

A raised crosswalk sign assembly (see **LADOT Standard Drawing S-483.1**) shall be used at the crossing consisting of:

- a W11-1, W11-2, or W11-15 depending upon context,
- a RAISED CROSSWALK plaque (W17-1bP),
- the W16-7p, and
- an advisory speed plaque (W13-1) displaying the recommended advisory speed

If warning beacons are used, they should supplement the raised crosswalk sign assembly.

At channelized right turns, a raised crosswalk sign assembly is not needed if the crosswalk is stop or yield controlled. The stop or yield control should be supplemented with a RAISED CROSSWALK plaque (W17-1bP).

The advance raised crosswalk sign assembly shall be used in advance of the raised crosswalk.

6.5.3.4 Bollards

Rigid bollards should not be used at raised crosswalk locations unless there is a documented history of vehicle encroachment. The use of z-gates, bollards, or other physical obstructions within a shared use path or bicycle lane crossing to slow bicyclists or to force bicyclists to dismount is not appropriate. These treatments present a crash hazard for bicyclists and can create situations where bicyclists are forced to queue into traffic while other users navigate through the obstructed area.

Delineators should be used to delineate the edge of the sidewalk and the roadway at raised crosswalks. It is preferable that they be located on the outside edges of the crosswalk. They should be visible and retroreflective. It is preferable they be flexible with a minimum height of 40 in. and minimum diameter of 4 in.

If they are needed within a crosswalk, it is preferable that they be spaced at 72 inches apart to maximize the accessibility of the crosswalk for pedestrians who may have assisted mobility devices or carriages and to bicyclists who may be operating bicycles with 3 or more wheels (see **Figure 6-8**). Bollards should not be centered along the bicyclists path or lane, but on the edge to minimize crash risk.

Figure 6-8 Raised Crosswalk at Channelized Right Turn



6.5.4 Drainage Considerations to Crossing Profile

Similar to **Curb Extensions**, raised crosswalks may create a new low spot due to the existing cross slope and longitudinal slope of one, or both intersecting streets. For this reason, implementing a raised crosswalk at the same location as a curb extension should be considered.

Supplemental Design Guide Detail 600 addresses the stormwater considerations for raised crossings. The following considerations apply to selecting the appropriate design of the raised crossing:

6.5.4.1 CASE A – *New Catch Basin(s) or where positive drainage is feasible*

Case A is the default design for a stormwater at a raised crossing. The raised crossing is located between 3" and 4" above the existing pavement, and the sidewalk is lowered with either a depressed corner or with curb ramps (see **Supplemental Design Guide Detail 600**) to create a level crossing location (see **Figure 6-10**).

Where the change in street elevation will prevent positive drainage, a new side opening catch basin is installed upstream of the raised crossing. This may only be feasible on streets with existing stormwater infrastructure. If the raised crossing is located at an intersection, but the existing side opening catch basin will be impacted by the addition of the raised crossing, it is preferred to convert this structure to a maintenance hole, and to connect a new side opening catch basin to this structure. This avoids a new connection to the main stormwater conveyance line. This is similar to the preferred method of installing new drainage structures for Curb Extensions.

6.5.4.2 CASE B – *Sidewalk Culvert(s)*

Case B uses a raised crossing that is 4" above the existing pavement and the sidewalk is lowered with either a depressed corner or with curb ramps (see **Supplemental Design Guide Detail 600**) to create a level crossing location. In this instance, a sidewalk culvert is used at the existing gutter, to allow the existing flow line to continue (see **Curb Extension** and **Figure 6-9**). This design is preferable in locations where there is not existing stormwater infrastructure, and where positive drainage is not achievable.

The design of the sidewalk culvert should follow **BOE Standard Plan S-322**, which requires a depth of at least 4" to install the culvert, or **BOE Standard Plan DL-2327** which may require additional depth to accommodate a concrete lid. See **Maintenance Considerations** for more information on maintenance of sidewalk culverts.

The street should be designed such that the sidewalk culvert is visible to all street users. Flexible delineator posts and/or pavement marking should be used upstream of the raised crossing to ensure motorists and bicyclists do not inadvertently use this space (see **LADOT Standard Plan 483.1**).

6.5.4.3 CASE C – Existing Gutter Flow

Where Case A is not feasible, and where a Case B is not desirable, the existing gutter flow should be maintained by sloping the raised crossing down to match the edge of the gutter (see **Figure 6-11**). This is achieved by using a transverse ramp. This design is only feasible where there is unrestricted (by time of day) on-street parking, which ensures that the transverse ramp occurs outside of the travel lane.

The slope of the transverse ramp is limited to 5%; therefore, this design is only applicable to streets with an existing cross slope not exceeding 3.33%. On streets with a cross slope exceeding 3.33%, the transverse ramp will not be able to achieve a raised crossing within the parking area.

When this design is feasible, a full height raised crossing may not be achievable. The raised crossing should be between 2" and 4" above the existing pavement. The sidewalk should meet the existing gutter elevation by using a curb ramp. The sidewalk should not be depressed with this design, which would lower the existing curb height, resulting in a wider gutter pan to achieve sufficient stormwater flow capacity.

Figure 6-9 Example of Case B Raised Crosswalk with Sidewalk Culvert (Edmond, OK)



Figure 6-10 Case A Raised Crosswalk

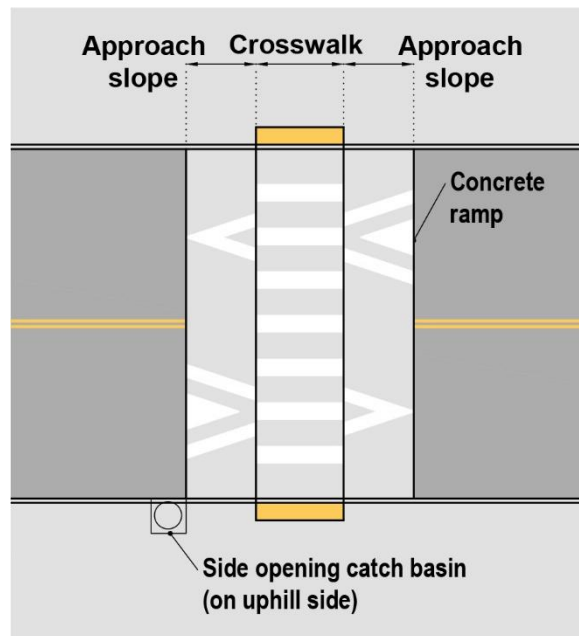
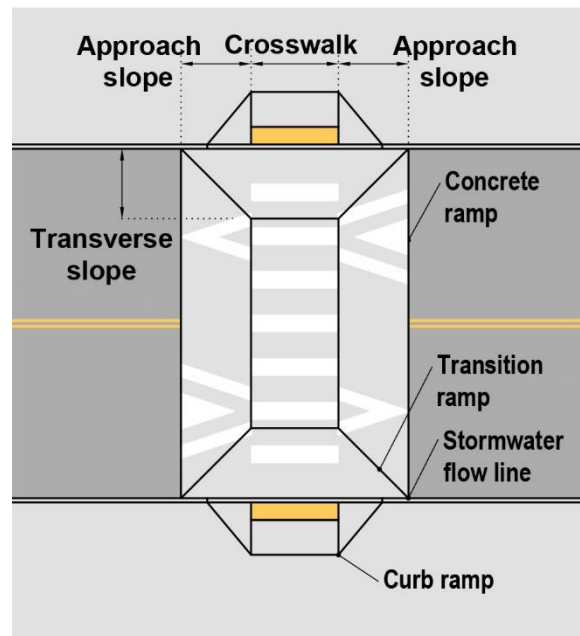

Figure 6-11 Case C Raised Crosswalks



6.6 ACCESSIBILITY CONSIDERATIONS

As stated in **Section 6.5.2.3**, a raised crosswalk is considered part of an accessible route for people with disabilities. Therefore, the surface must be smooth, stable, and slip-resistant with a maximum cross slope of 2-percent perpendicular to the pedestrian path of travel in the crosswalk (along the longitudinal path of the street).

Additionally, the longitudinal slope of the crosswalk (along the path of the pedestrian) should be no greater than 5%. On streets with steep cross slopes, this becomes problematic because it would result in an uneven surface that would be difficult to construct. It is preferable to mill the crown to achieve the 5% maximum slope to the maximum extent practicable. Exceptions may be approved by the ADA Coordinator where lowering the crown is not practicable and the 5% slope would result in the raised crosswalk not being provided where the raised crosswalk is necessary to address safety goals. For these limited cases the intersection should be programmed for future reconstruction to lower the crown and ensure the crossing meets accessibility requirements.

As discussed in **Section 6.5.2.3**, crosswalks will require the approach sidewalk to be lowered to create a slightly depressed corner or the installation of curb ramps to connect the sidewalk to the raised crosswalk. Curb ramps should be installed following the guidance of **BOE Standard Plan S-442**. Where depressed corners are used to negate the need for curb ramps at the crosswalk, a detectable warning surface is required to demarcate the edge of the sidewalk. At locations with sidewalk level protected bike lanes or shared use paths, the detectable warning should extend across the full width of the crossing unless the protected bike lanes are physically separated from the sidewalk or a directional indicator strip is provided.

On streets with steeper cross slopes, it may be advantageous to consider combining the raised crosswalks with **Curb Extensions** where parking is unrestricted by time of day. Since curb extensions may require a portion of the street to be resurfaced to achieve appropriate landing areas and cross slopes, implementing a raised crosswalk may have a similar cost while providing more benefit to pedestrians.

While it is preferred to install directional curb ramps at intersection corners, which can be done in conjunction with raised crosswalk implementation, there may be other utilities and appurtenances (i.e. signal cabinets, light poles) which would significantly increase the scope of the raised crosswalk project to install directional ramps. In this case, a raised crosswalk set back from the intersection may allow the existing utilities to remain, while the existing corner ramp is repurposed to serve a single crossing. This should be seen as a temporary solution as a person in wheelchair will still need to turn within the curb ramp street landing to orient themselves to the crossing within the street instead of being able to orient on themselves on the sidewalk (See **Figure 6-12**). It is preferable to limit out of direction travel for crossing pedestrians; crossings may be set back between 6 feet and 30 feet. Visibility sight lines for pedestrians must be taken into consideration with this option.

Figure 6-12 Setback Raised Crosswalk

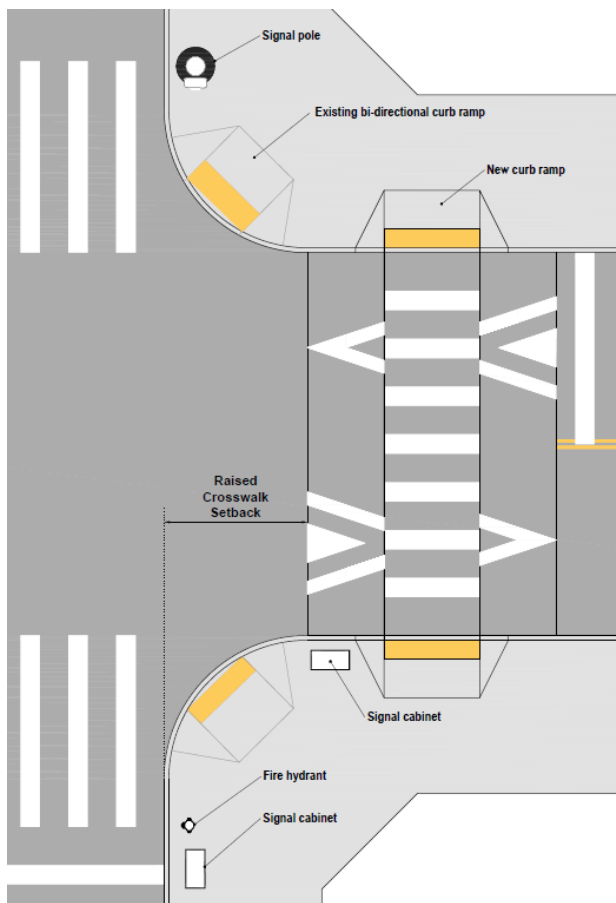

Detectable warning shall be installed at both ends of the raised crosswalk, extending the entire width of the top of the raised portion as shown on the **Supplemental Design Guide Detail 600**.

6.7 MAINTENANCE CONSIDERATIONS

Raised crosswalks should be inspected annually for deformations and pavement marking visibility. See **Section 6.5.1.2** for additional discussion.

Weekly street cleaning prohibits parking, allowing street sweepers to clean the street. If a sidewalk culvert is used (see **Section 6.5.4.2**), access points or removable covers should be provided to allow for regular cleaning to maintain adequate stormwater capacity. The access points and covers should be designed to minimize damage caused by normal maintenance activities and deter vandalism.

Asphalt constructed ramps should be monitored for raveling and deformity. They should either be repaired, or the entire raised crosswalk replaced, once ramps deform and no longer provide the desired performance characteristics or comply with ADA requirements.

During street resurfacing, special care should be taken with raised crossings. They should either be removed and rebuilt (if asphalt), or the resurfacing should stop 5 feet short of the approach and departure ramps with a milled surface to ensure a smooth transition to the ramps. Overlaying a street up to the raised crosswalk and feathering pavement to the approach will reduce the ramp profile, thereby reducing traffic calming effects of the device.

Due to the importance of warning motorists of the raised crosswalk, it is important for the pavement markings and signs be maintained to maintain the conspicuity of the devices. Integrating color throughout the raised crosswalk material or surface can be an effective strategy to increase its conspicuity to the adjacent street and minimize the need to rely on pavement markings.

7 NEIGHBORHOOD TRAFFIC CIRCLE OR MINI-ROUNDAABOUT

7.1 OVERVIEW

Neighborhood traffic circles and mini-roundabouts are two closely related types of intersection treatments typically used as traffic calming measures at intersections. Neighborhood traffic circles and mini-roundabouts are visually similar because of their use of traffic islands placed in the center of an existing intersection; however, there are functional differences between the two and they are used in different contexts.

Mini-roundabouts are primarily used on two-lane collector streets and require all vehicles to yield to traffic in the roundabout and traverse counterclockwise around the circle. Because of their traffic calming effects, they are installed primarily to reduce crashes, and also to reduce delays at minor approaches. Mini-roundabouts share the characteristics of standard roundabouts with approach splitter islands and yield control on each approach. The splitter island may be raised or painted. The central island may be raised with a mountable apron (See **Figure 7-1**) or completely mountable (see **Figure 7-2**) with a modified Type E Curb (Supplemental Design Guide Detail 710) to constrain the circle size while still accommodating larger vehicles. Where the diameter of the center circle is less than 8 feet, it may be painted. Mini-roundabouts are typically constructed to fit within existing curb lines at intersections but in some locations, may require reconstruction of curb returns to accommodate larger design vehicles. In most cases the addition of new accessible curb ramps will be necessary to accommodate pedestrians at a crossing recessed from the circle (see **Supplemental Design Guide Detail 710**). The intersecting streets will typically have marked center lines.

Neighborhood traffic circles are primarily used at four-legged, two-lane local streets (see **Figure 7-3**) and are installed to reduce crashes and slow traffic speeds. The intersection may have stop control on one or more approaches. Splitter islands are not required, and the central island is typically raised with a mountable apron to prevent a straight-through movement of the Design Vehicle. The occasional Control Vehicle should not be precluded from operating within the intersection with encroachment, if necessary. Landscaping may be planted with the center median. The local streets typically do not have marked center lines.

The design of traffic circles, rotary intersections, and full-size standard roundabouts are not provided in this guidance.

Figure 7-1 Example Mini-Roundabout with Raised Center Island



South Harvard Boulevard Los Angeles, CA

Figure 7-2 Example Mini-Roundabout with Mountable Center Island

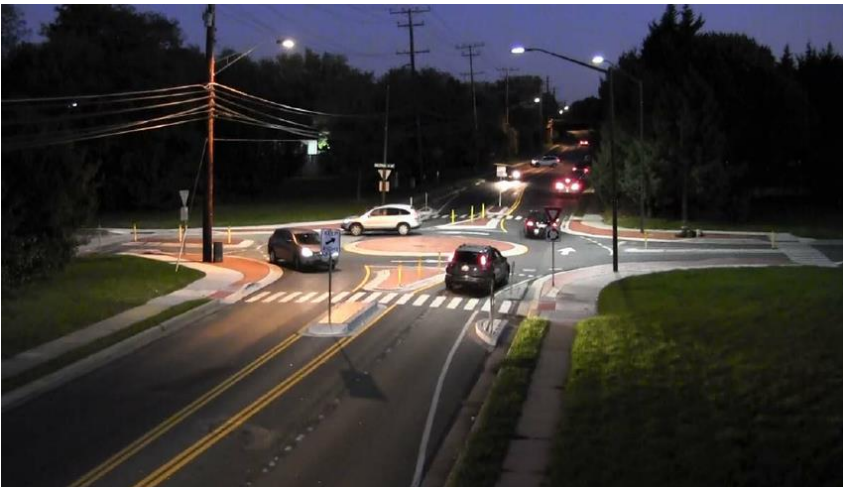

S. Tollgate Rd and W. MacPhail Rd, Bel Air, MD

Figure 7-3 Example Neighborhood Traffic Circle



Seattle, WA

7.2 DEFINITIONS

Neighborhood Traffic Circle: A type of roundabout characterized by a small diameter central circulating island which is raised. The circle may include a mountable apron, but the approaches do not have splitter islands.

Mini-Roundabout: A type of roundabout characterized by a small diameter central circulating island which may be raised, partially traversable, or fully traversable. Raised or traversable splitter islands are provided on all approaches.

7.3 GENERAL BENEFITS AND DESIGN CONSIDERATIONS

Mini-roundabouts and neighborhood traffic circles have the following benefits and challenges.

7.3.1 Benefits

Mini-Roundabout and Neighborhood Traffic Circles:

- Can provide traffic calming effects by reducing speeds, creating visual cues for drivers to approach the intersection with more caution, and by creating a curved path of travel through the intersection rather than a straight-through path
- Can reduce the number and severity of collisions at intersections by reducing the angle of impact and speed of vehicles, potentially eliminating all angle crashes

Mini-Roundabout:

- Can improve operational efficiency of the intersection and reduce crashes by replacing existing 4-way stops or signalized intersections
- More compact than a traditional roundabout
- May provide opportunity for added landscaping and neighborhood enhancement if circle size is sufficient and is not fully traversable
- Can accommodate continuous volumes of vehicles
- Can accommodate larger vehicles

Neighborhood Traffic Circles:

- Can help establish proper right-of-way and reinforce driver yielding behaviors, thereby reducing crashes
- Typically provides opportunity for added landscaping and neighborhood enhancement
- Can improve the pedestrian and bicycling environment by slowing vehicle speeds
- Can retrofit into existing curb lines
- In some cases, it may be possible to maintain the existing bi-directional pedestrian curb ramps (confer with ADA coordinator for site-specific requirements)

7.3.2 Design Considerations

Mini-Roundabout and Neighborhood Traffic Circles:

- Landscaping will require additional maintenance

Mini-Roundabout:

- Diagonal curb ramps will require reconstruction to uni-directional curb ramps to direct pedestrians to crossing points 20 feet from the circulating street

- At locations with uni-directional curb ramps, a non-walkable surface or curb will be required between the curb ramps to discourage pedestrians from entering the circulatory portion of the roadway
- May require reconstruction of some intersection corners to accommodate larger vehicles or to provide adequate deflection which would increase implementation costs
- The constrained space typically does not allow for the provision of separate bicycle facilities
- May reduce available on-street parking where crosswalks are relocated further away from the intersection

Neighborhood Traffic Circles:

- May make it more challenging for larger vehicles to traverse (e.g., WB-40)
- Curb may be damaged where it is routinely driven over, requiring replacement or repair
- May require restrictions to truck access

7.4 APPLICATIONS

Both mini-roundabouts and neighborhood traffic circles are used only on two-way, two-lane streets (one travel lane in each direction). Parking lanes may also be present. In some rare cases where one of the crossing streets may be one-way, it should only be a single lane. On multi-lane streets (three or more total travel lanes) a standard roundabout should be used.

Both mini-roundabouts and neighborhood traffic circles can be used as a component of a Neighborhood Enhanced Network (NEN) route to enhance the comfort and safety of bicyclists and pedestrians.

At intersections where the total average daily traffic volumes (AADT) exceed 15,000 vehicles per day, traditional roundabouts should be considered in place of mini-roundabouts.

7.4.1 Mini-Roundabouts

Mini-roundabouts can be used to slow traffic while minimizing traffic delay on higher volume collectors or local streets that accommodate larger vehicles on a daily basis. A fully mountable center island is recommended, though a raised center island may be used in less constrained corridors. Mini-roundabouts can be considered:

- at any two-lane local or collector street intersection where average total entering daily traffic volume is less than 15,000 vehicles
- at any Local or Collector street intersection with a posted speed limit of 30 mph or less
- at existing intersections to replace two-way stop control, all-way stop control, or a traffic signal where all-way yield control is desired
- at intersections with imbalanced traffic volumes between the major and minor legs to help reduce delays on minor approaches

7.4.2 Neighborhood Traffic Circles

Neighborhood traffic circles can be used to slow traffic and improve neighborhood aesthetics on lower volume neighborhood streets where it is not as necessary to accommodate larger design vehicles except on an occasional basis. Neighborhood traffic circles can be considered:

- at any local or collector street intersection where total entering average daily traffic (ADT) volume is less than 5,000 vehicles and heavy vehicles are less than 2% of total ADT
 - If a given location sees unusually high peak hourly volumes and heavy vehicle traffic in excess of 2% of the hourly volume, a mini-roundabout should be considered
 - The installation of neighborhood traffic circles will not typically change traffic patterns and volumes, but in some limited cases it may reducing vehicle traffic by redirecting heavy vehicle traffic that wish to avoid the circle
- at existing intersections where it is desired to supplement two-way or all-way stop control (on NEN routes with two-way stop control, the stop control should be located on the non-NEN legs)

Figure 7-4 Schematic Examples of Mini-Roundabouts and Neighborhood Traffic Circles

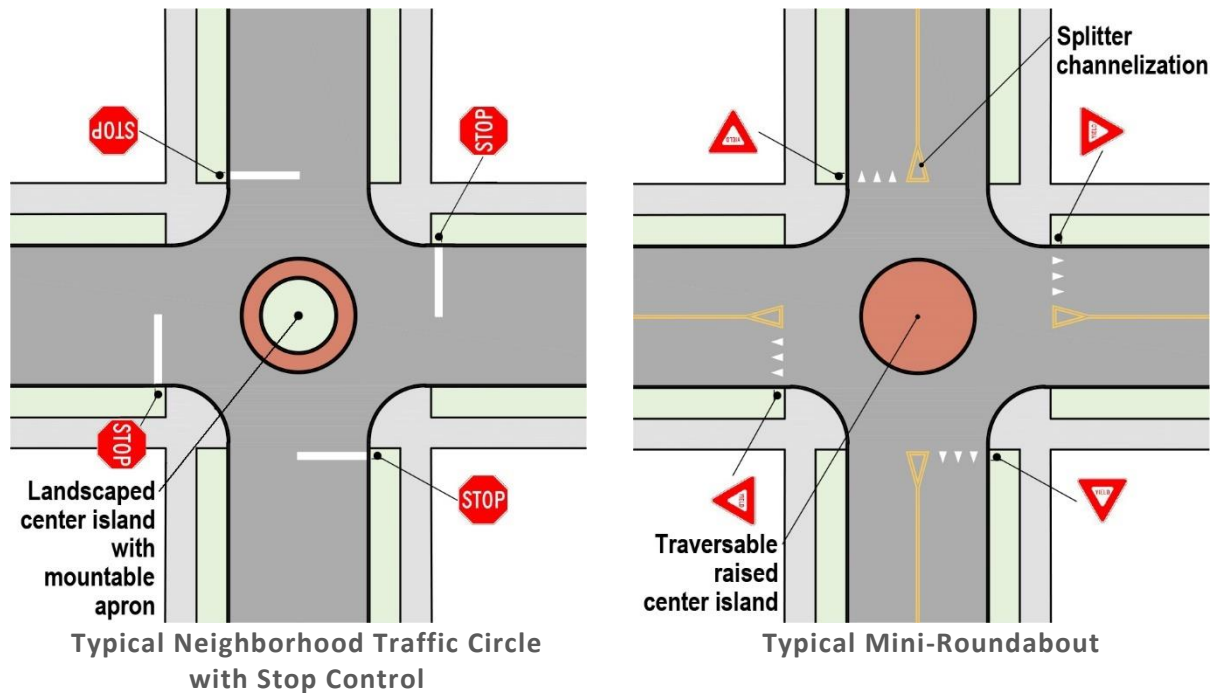

7.5 DESIGN GUIDANCE

7.5.1 Geometry

Mini-roundabouts and neighborhood traffic circles are both used at existing intersections in which the existing curb lines establish an inscribed circle diameter that is less than 90 feet in width (**Figure 7-5**). If the inscribed circle diameter exceeds 90 feet, then a single-lane standard roundabout design should be used.

Figure 7-5 Key Geometric Elements

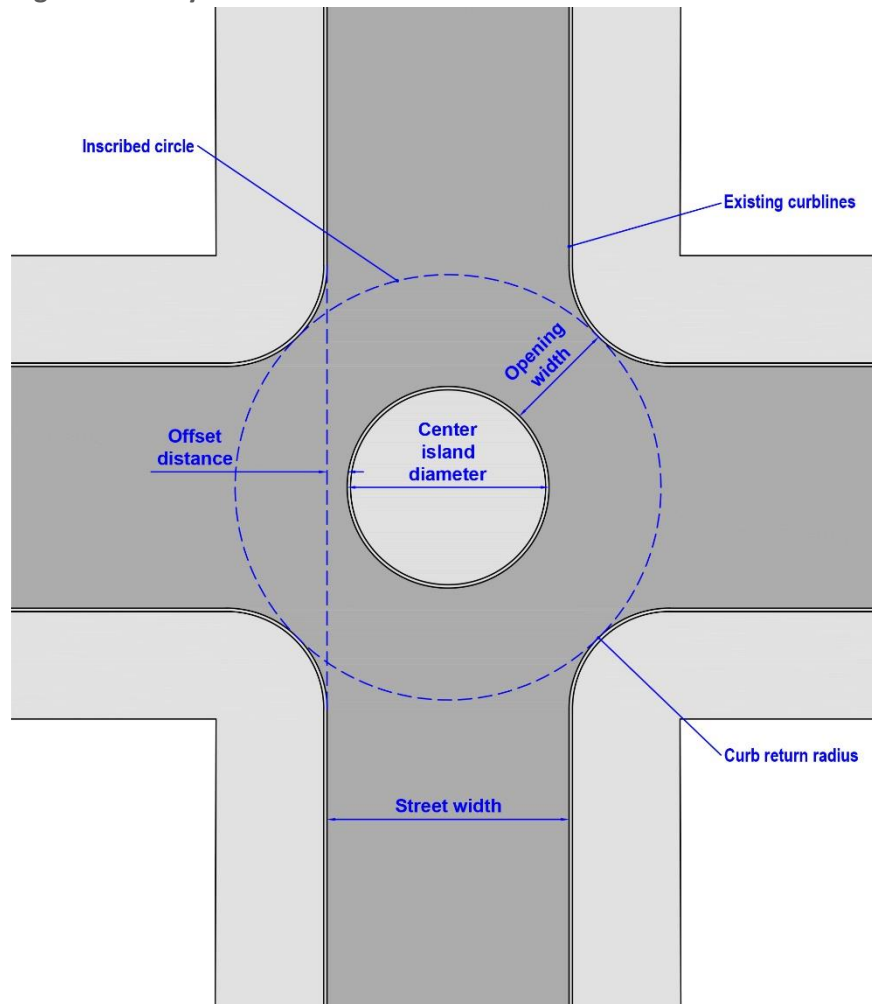

7.5.1.1 Deflection

The efficacy of both mini-roundabouts and neighborhood traffic circles is dependent on the principle of ‘deflection’, which is the degree to which a vehicle passing through an intersection must deviate from a straight line through the intersection. The goal is to provide adequate deflection to achieve slow speeds (15 mph or slower) both approaching, traveling through, and departing the intersection¹⁹.

For intersections using mini-roundabouts without splitter islands, or neighborhood traffic circles, deflection is achieved solely by the path of travel defined by the edge of the center island and the curb returns at the corners of the intersection. For this reason, it is vital that the physical curb returns be located along the perimeter of the inscribed circle of the intersection, which defines the outer limits of a vehicle’s path of travel. Any offsets between a striped circular lane and the physical curb returns will dramatically reduce the efficacy of the intersection treatment by allowing straighter paths of travel through the intersection.

As a general rule, the offset distance shown in **Figure 7-5** should be a maximum of 5.5 feet. The use of the center island sizing chart below will provide center islands that meet this requirement. Additional

¹⁹ FHWA, *Roundabouts: An Informational Guide, 2nd Ed.*, 2010

detail is provided in the standard plans. It may be necessary to constrain the approach with **Curb Extension** or **Truck Aprons** or to reconstruct the **Corner Radius** to achieve this constrained path.

Section 7.7 provides considerations related to curb ramp placement and accessibility requirements.

7.5.1.2 Center Island

The diameter of the center island for mini-roundabouts and neighborhood traffic circles is generally determined by the table below which establishes a starting point for establishing the center island diameter based upon existing curb return radii located at existing intersections. The largest curb return radii at the intersection should be used to establish the initial center island diameter.

Table 7-1 Center Island Sizing Chart

Street Width	Curb Return Radii	Center Island Diameter
28'	15'	18'
<i>(Hillside Local Limited)</i>	20'	20'
	25'	22'
30'	15'	20'
<i>(Local Street Limited)</i>	20'	22'
	25'	24'
36'	15'	27'
<i>(Local Street Standard)</i>	20'	29'
	25'	33'
40'	15'	32'
<i>(Collector)</i>	20'	34'
	25'	38'

These dimensions provide a circulating lane width between 16 to 20 feet, which can accommodate a DL-27 design vehicle. If a 16-foot circulating width is provided, an additional 4-foot width mountable truck apron may be required to accommodate larger vehicles while ensuring lower vehicle speeds for passenger vehicles. In all cases, a minimum circulating space inclusive of truck aprons of 20 feet is required. Final designs should incorporate the specific geometrics available at a given intersection, the chosen design vehicles, and left turn accommodations for those vehicles.

It may be necessary to consider truck aprons for Neighborhood Traffic Circles. The center island should allow delivery vehicles (DL-27) to navigate the intersection without mounting the apron, while allowing the occasional Control Vehicle to use the intersection with encroachment, if necessary. If the SU-30 is expected to be accommodated with regular frequency, the center island should be fully mountable as a truck apron.

At locations where curb radii vary substantially, reconstruction of the intersection should be considered to ensure that the desired operational and traffic calming benefits are achieved. At locations where the intersecting streets have very different widths, **Curb Extension** should be considered on the wider street in order to create consistent approach widths and to allow the use of a circular center island.

The pavement color and texture within the central island should be distinct from the adjacent street to discourage most motorists from driving over or on the island. This also helps pedestrians understand

that this is not a designated waiting area. The City will approve the use of any color and/or textured concrete.

7.5.1.3 Corner Radii

Because both mini-roundabouts and neighborhood traffic circles are intended to be retrofitted to existing street intersections, **Corner Radii** dimensions should be 25 feet or less. Larger radii allow higher speeds for right turns, which can negate the goal of slower traffic speeds; if larger radii are present, constraining the corner radii with **Curb Extension** or **Mountable Truck Apron** or **Pillow** or reconstructing the **Corner Radius** should be considered.

7.5.2 Mini-Roundabout Materials, Markings & Signs

7.5.2.1 Center Island

In most locations a mini-roundabout will use a fully traversable center island to accommodate larger vehicle left turn movements. They would have to encroach onto the center island to turn because they cannot be accommodated on the circulating path around the circle. On corridors without transit and no expected volumes of heavy vehicle traffic, the center island of a mini-roundabout may be fully raised in the same manner as a neighborhood traffic circle. Partially-traversable islands (raised center islands with wider truck aprons) may also be used in certain locations.

Traversable center islands should be domed using 5 to 6% cross slope, with a maximum height of 5 inches to encourage most vehicles to remain on the circulating path around the circle.

7.5.2.2 Splitter Island

Splitter islands should be provided on each approach to the circle to guide vehicles around the center island in the proper direction of travel and to create a defined pedestrian crossing point that is 20 feet from the circulating street. Mountable islands are preferred, but islands may be painted when the available geometry of the intersection would result in islands less than 50 square feet in size. See **Supplemental Design Guide Detail 710**.

7.5.2.3 Pavement Markings

Centerline striping should be used on all approaches to mini-roundabouts. If there is none, a 20' centerline should be added on each approach to the splitter island. This may require removal of on-street parking on narrow streets to accommodate 10' minimum travel lanes in each direction.

Yield pavement markings should be provided at the edge of the circulatory street for each approach to the intersection, outside of the travel path of the inscribed circle of the intersection. Yield markings should be placed for the full width of the entry lane, from the centerline striping to the edge of lane.

Reflective pavement markings should be used on the curbing of the center island and splitter islands to improve visibility of the islands at night. Type D pavement markers placed on the yellow center line are required for painted center islands and splitter islands.

Marked crosswalks should be provided at all intersections where pedestrians are expected to cross. They should be placed 20 feet from the inscribed circle of the intersection. This may result in the need to relocate existing pedestrian curb ramps. Diagonal curb ramps that direct pedestrians into the circulating lane are not permitted; existing diagonal curb ramps must be replaced by uni-directional ramps.

See **LADOT Standard Drawing S-524.0** for additional guidance on the use of pavement markings at mini-roundabouts.

The pavement color and texture within the splitter island should be distinct from the adjacent street and sidewalk to discourage most motorists from driving over them. Colored and/or textured concrete may be used upon approval from the City.

7.5.2.4 Signs

Yield signs should be provided adjacent to the yield markings for each approach.

A pedestrian (W11-2) or pedestrian/bicycle (W11-15) crossing assembly (including the W16-7p) should be provided at each crosswalk. Pedestrian activated Rapid Rectangular Flashing Beacons (RRFBs) may be used to increase motorists yielding upon approval by LADOT.

If a raised center island is used, roundabout directional arrow signs (R6-4) should be included in the center island to guide drivers around the circle in the appropriate counter-clockwise direction. If the center island is not large enough to accommodate signs, or if the center island is entirely traversable, roundabout circulation plaques (R6-5P) should be placed below the yield signs at each approach. See **CA MUTCD Sections 2B.43 through 2B.45**, and Figures 2B-21 and 2B-22, for additional guidance.

7.5.3 Neighborhood Traffic Circle Materials, Markings & Signs

7.5.3.1 Center Island

The outside two feet of a neighborhood traffic circle should be constructed as a raised, semi-mountable concrete curb apron, doweled to the existing pavement. The center island should allow delivery vehicles (DL-27) to pass by without mounting the apron, while still accommodating the occasional Control Vehicle to use the intersection with encroachment, if necessary.

Landscaping and/or stormwater elements may be provided within the interior of the raised center island as needed. The landscaping should be raised with a central mound to allow excess water to drain out of the island. In these cases, maintenance is required.

7.5.3.2 Pavement Markings

Neighborhood traffic circles are typically used on neighborhood streets that do not include centerline markings due to the low traffic volume. Centerline markings are not required if they do not already exist on the approaches to the intersection.

Reflective pavement markings should be used on the curbing of the center island to improve visibility of the center island at night.

If marked crosswalks are used, they should be placed outside the limits of the inscribed circle of the intersection. This may require relocating existing pedestrian curb ramps.

7.5.3.3 Signs

Neighborhood traffic circles are often used in conjunction with existing intersection traffic control (non-signalized). Neighborhood traffic circles can be used at locations with two-way stop control or all-way stop control (see **Figure 7-6**).

On the center island, traffic circles should include a yellow high intensity Type 1 object marker for each approach and may include “Circular Traffic” (R6-5p) signs mounted in the center island to guide drivers around the circle in the appropriate direction. Reflective object markers are also often used to assist drivers in recognizing the presence of the traffic circle at night. See CA MUTCD guidelines.

Figure 7-6 Example Neighborhood Traffic Circle with 2-Leg Stop Control (Arlington, VA)



7.6 SPECIAL CASES

7.6.1 ‘T’ Intersections

At ‘T’ intersections, or at three-legged intersections in which two opposing legs are nearly in line, the path of travel opposite the third leg of the intersection runs through the intersection without direct conflicts. Because of this, it can be difficult to achieve appropriate deflection through the intersection for that particular path of travel. Additional features such as chokers or **Curb Extension** should be employed along the straight-through path to ensure adequate deflection for vehicles traveling along that route.

Smaller islands should be used at ‘T’ intersections, with the center of the island shifted off-center in the intersection to provide enough width along the straight side of the intersection (See **Figure 7-7**).

Figure 7-7 Example 'T' Intersection Treatment

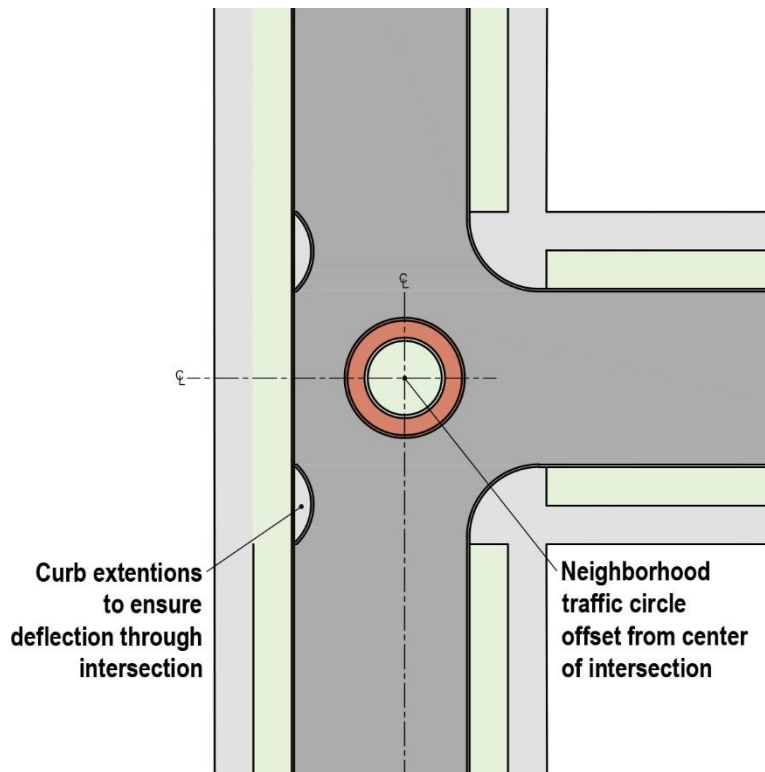

7.6.2 Community Identity Treatments

In some locations the local community may wish to include other special features in a neighborhood traffic circle, if the circle is of sufficient size. These features may include 'gateway' treatments, special signage, community artwork, or other special installations. Such treatments can provide significant community enhancement and character. Considerations for such treatments include:

- Treatments should not entirely block drivers' sight lines through the intersection
- Treatments should not present significant hazards in case of crashes
- Treatments should not invite people to walk to or otherwise occupy the center island
- All proposed treatments must be reviewed and approved by the City Engineer prior to installation

A revocable permit (R-Permit) will be required to install community identity features if proposed by a private party not authorized to occupy the right-of-way.

7.7 ACCESSIBILITY CONSIDERATIONS

Accessibility considerations vary considerably according to the existing conditions and context of each intersection. Considerations include, but are not limited to, the following:

- Pedestrians should not be directed to travel toward the circulating portion of the street at mini-roundabouts, since the circulating path is marked and established as a vehicular lane; for this reason, existing diagonal curb ramps must be removed if a mini-roundabout is used. See standard plan for location of new uni-directional ramps and crosswalks.

- Diagonal curb ramps at neighborhood traffic circles are not desirable and should be evaluated for replacement with directional curb ramps. However, diagonal curb ramps may be permitted to remain at some intersections without marked crosswalks if traffic approaching the intersection must stop for pedestrians legally crossing within the intersection control area regardless of the presence of the traffic circle; the presence of a neighborhood traffic circle does not establish a dedicated vehicular lane as does a mini-roundabout, and the location of unmarked crosswalks remains the same with or without the traffic circle. In practice, the use of traffic circles will generally improve motorist compliance yielding to pedestrians compared to identical intersections without a traffic circle.
- All projects must be evaluated to determine site-specific ADA compliance requirements.

7.8 MAINTENANCE CONSIDERATIONS

The center island space may be landscaped or hardscaped. Where plantings are used they should be native plants or drought resistant species. These species should be planted to not encroach onto the intersection or reduce motorist and pedestrian visibility to other potential conflicting users in the roadway. Planting, trees, street furniture, signs, or other obstruction within the center island must not inhibit intersection sight distances by ensuring a clear zone of visibility between 36 inches high and 80 inches high from the ground. Trees planted in a center island are not considered intersection sight distance obstructions if they are maintained to ensure a clear zone of visibility and will achieve an eventual mature clearance of 14 feet.

APPENDIX A:
Supplemental Design Guide Details
Bureau of Engineering

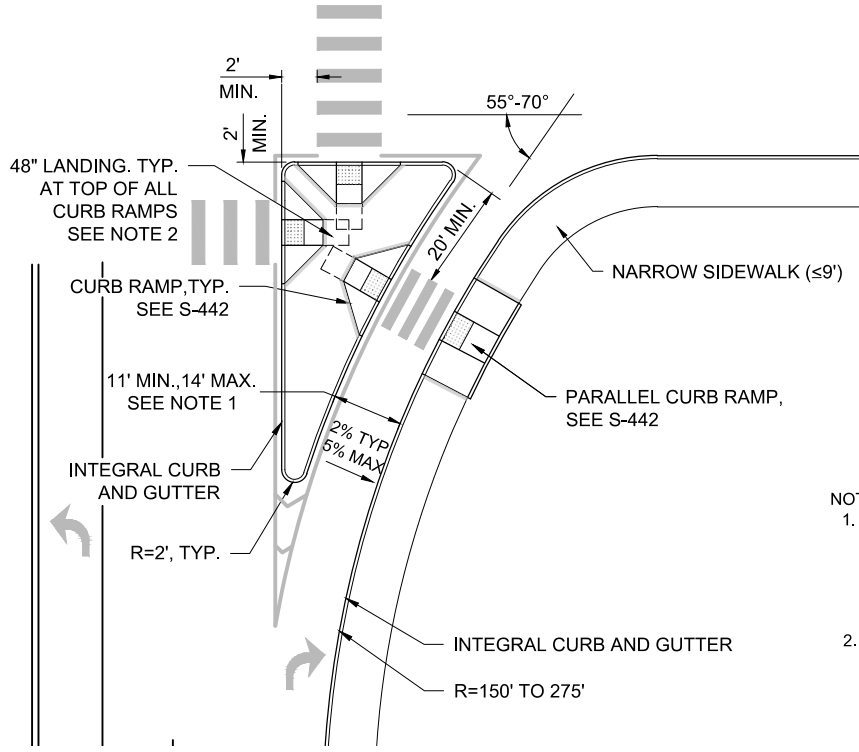
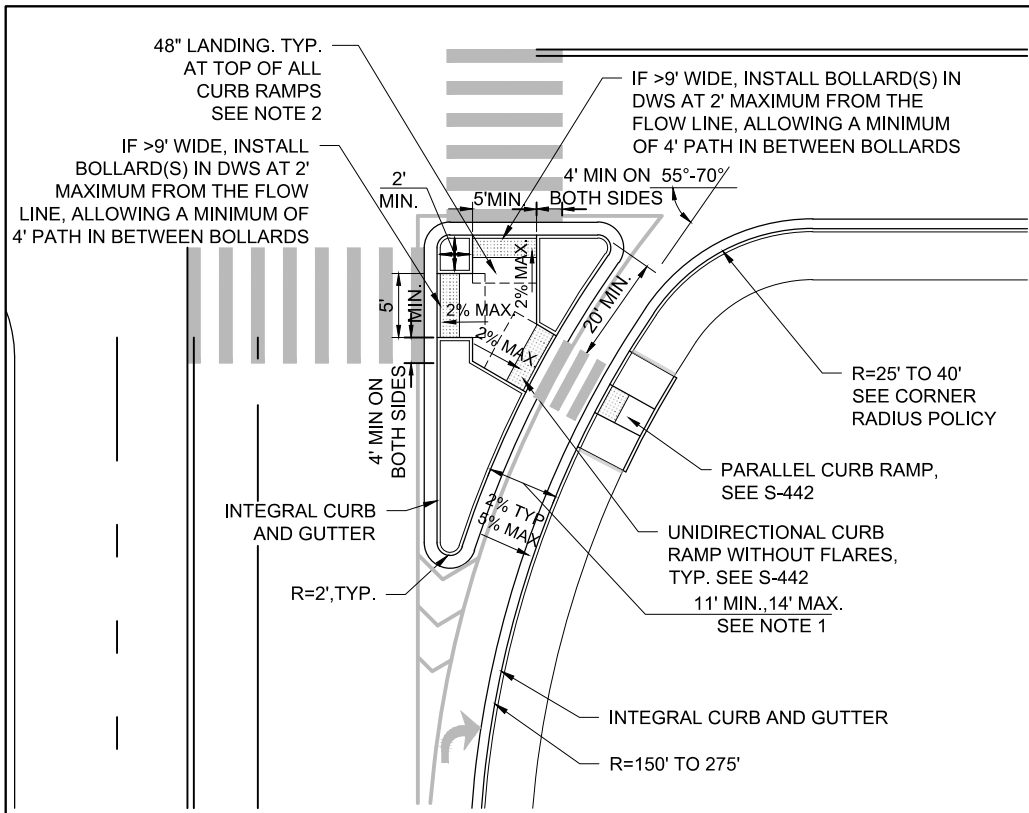

- NOTES:
1. PROVIDE MOUNTABLE TRUCK APRON ALONG OUTSIDE CURB LINE IF LANE WIDTH GREATER THAN 14' IS NEEDED TO ACCOMMODATE DESIGN VEHICLE.
 2. PROVIDE 48" MINIMUM CLEAR SPACE WITH 2% MAX. SLOPE IN ALL DIRECTIONS FOR LANDING AREA.

CONSTRAINED GEOMETRIC DESIGN FOR CHANNELIZED RIGHT TURNS

C:\Users\ccueva\Desk\top\Carloss\SSD\Supplemental Design\Final\Right Turn Slip Lane - BOE2.dwg
4/2/2020 1:29 PM

RIGHT ANGLE APPROACH

**SUPPLEMENTAL
DESIGN GUIDE**

DETAIL 100

SHEET 1 OF 2

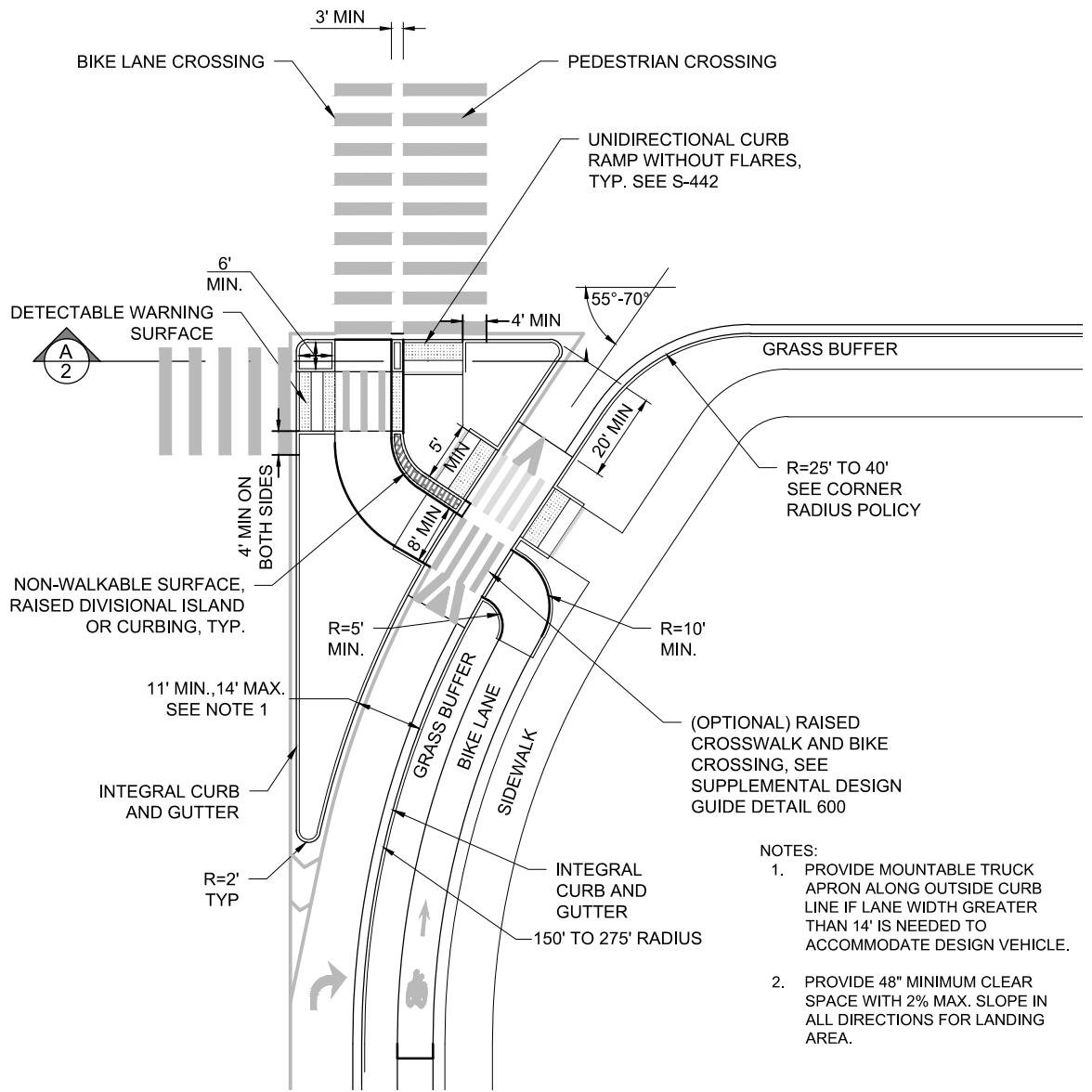

UNCONSTRAINED GEOMETRIC DESIGN FOR CHANNELIZED RIGHT TURNS

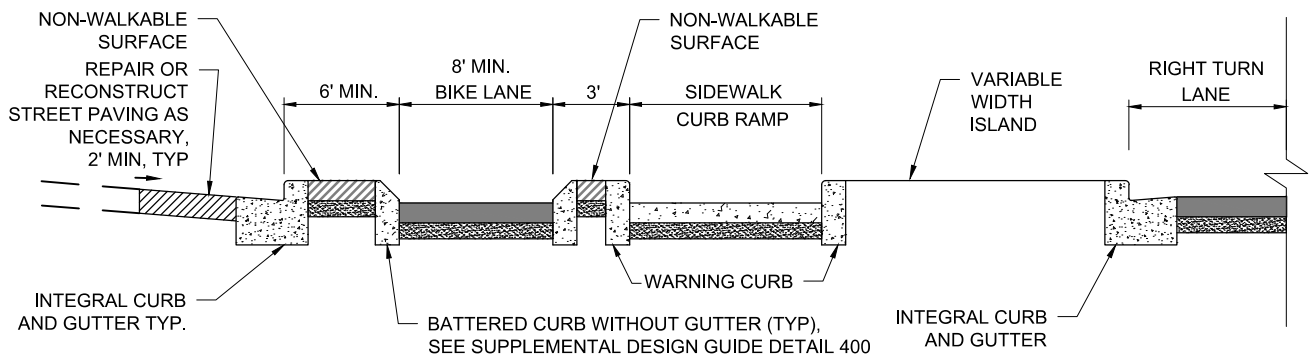

A
2 TYPICAL SECTION AT PEDESTRIAN/BICYCLIST ISLAND
STEEP ROAD CROSS SLOPES

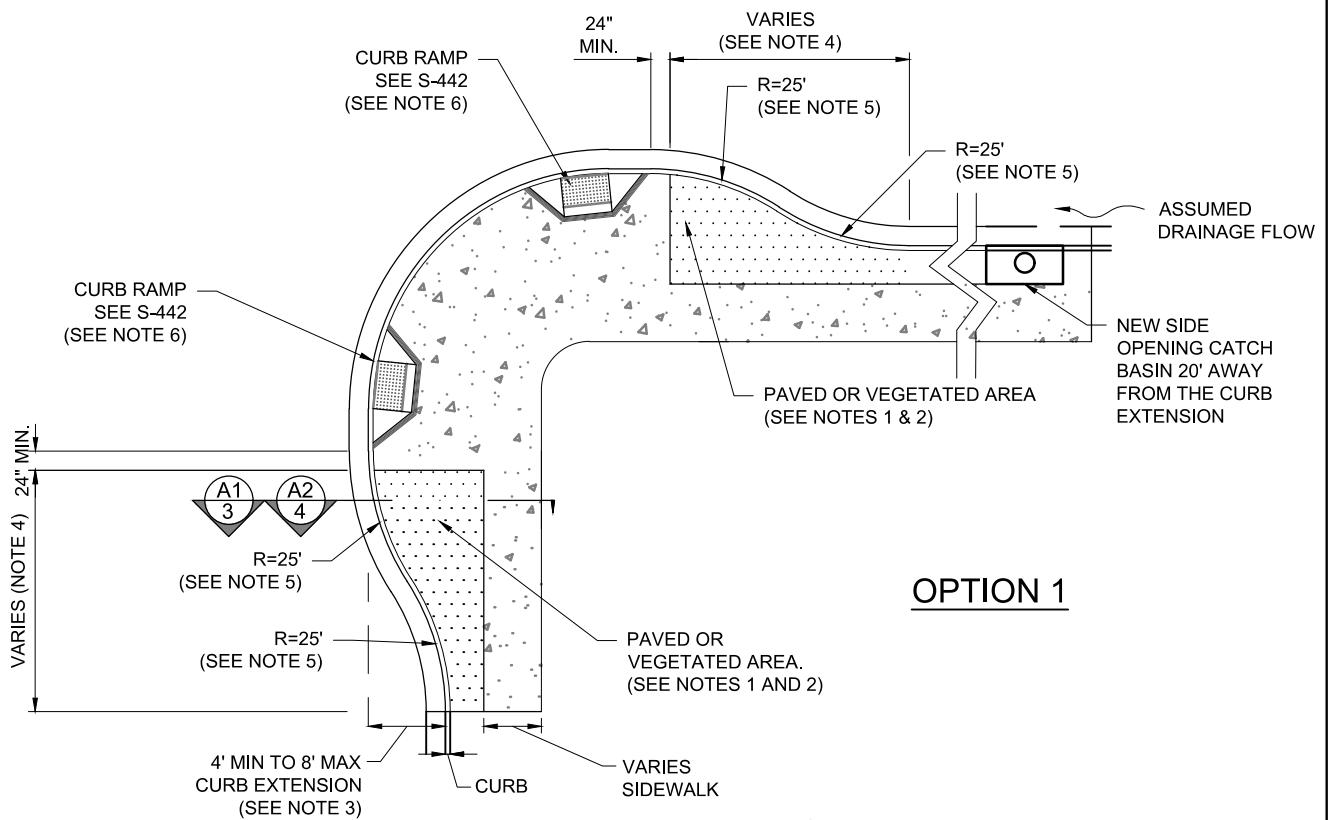

OPTION 1

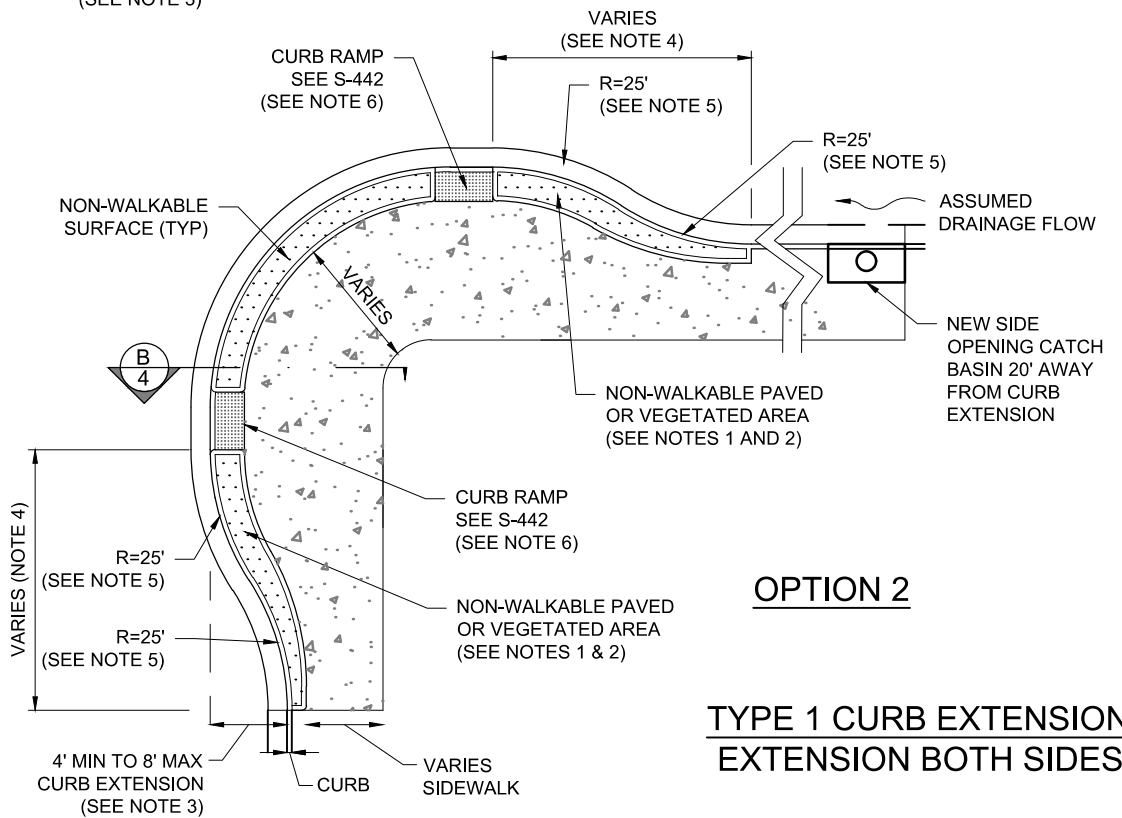

OPTION 2

**TYPE 1 CURB EXTENSION
EXTENSION BOTH SIDES**

CURB EXTENSION DETAILS

**SUPPLEMENTAL
DESIGN GUIDE**

DETAIL **200**

SHEET 1 OF 11

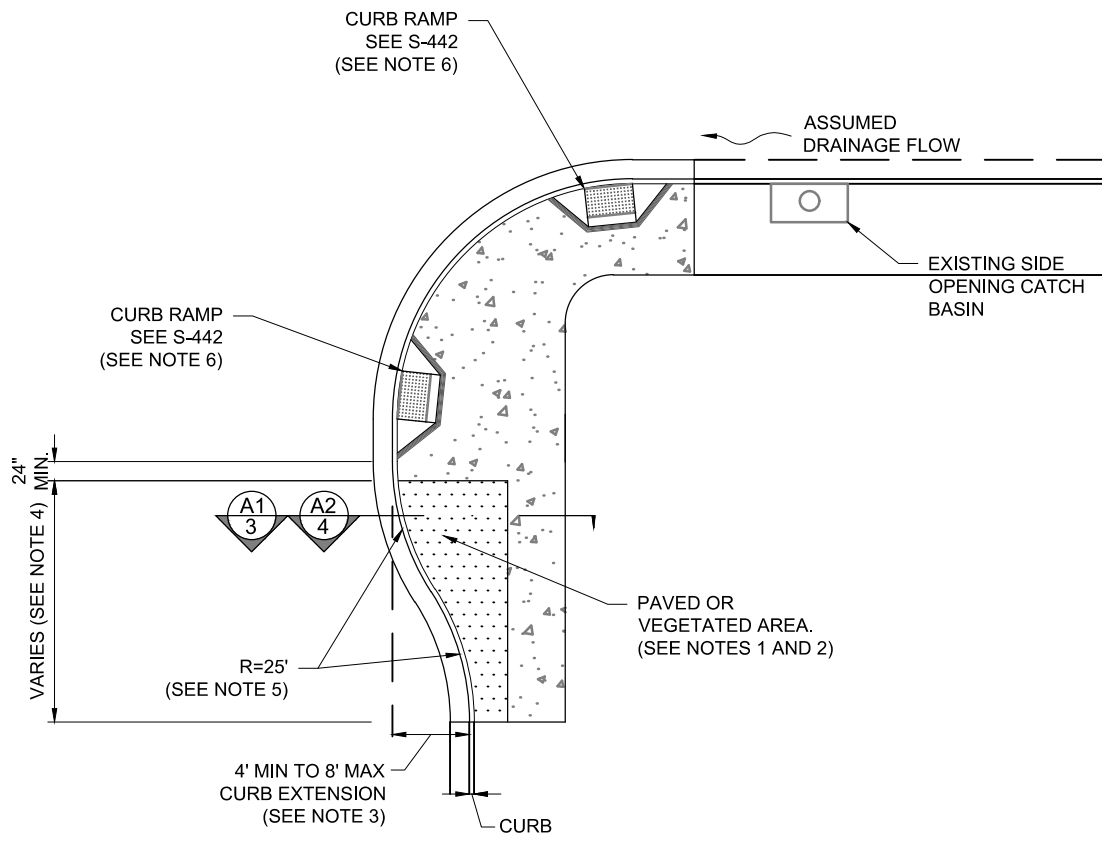

TYPE 1 CURB EXTENSION
EXTENSION ON 1 SIDE

C:\Users\ccueva\Desktop\Carlos\SSD\Supplemental Design\Final\Curb Extensions_BOE_DOT2.dwg
 3/31/2020 8:55 PM

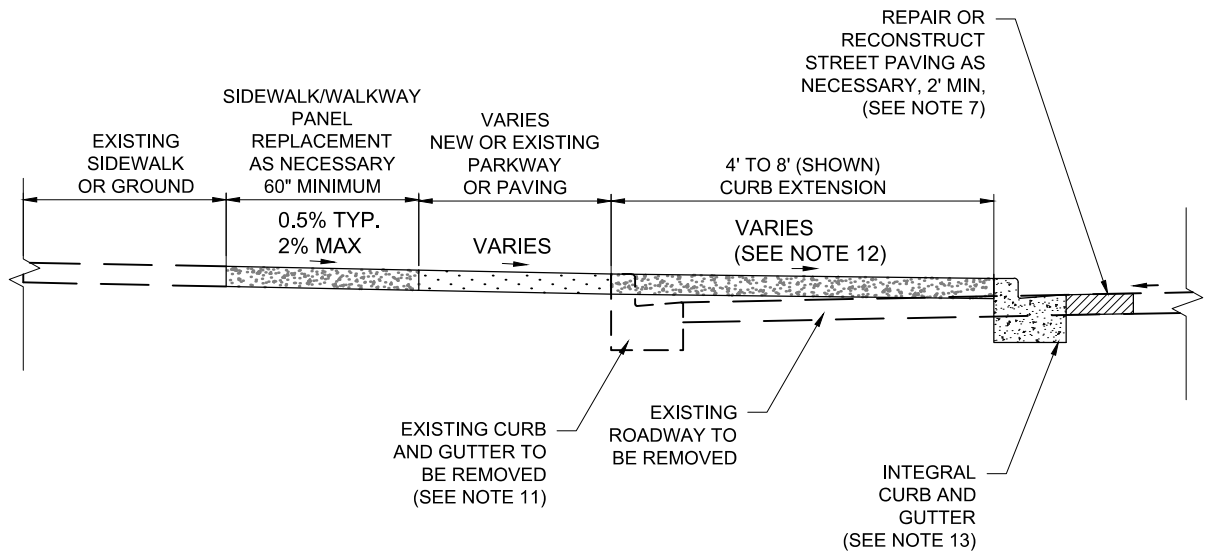

A1 TYPICAL SECTION AT CURB RETURN
 1,2 WALKABLE - SHALLOW ROAD CROSS SLOPES

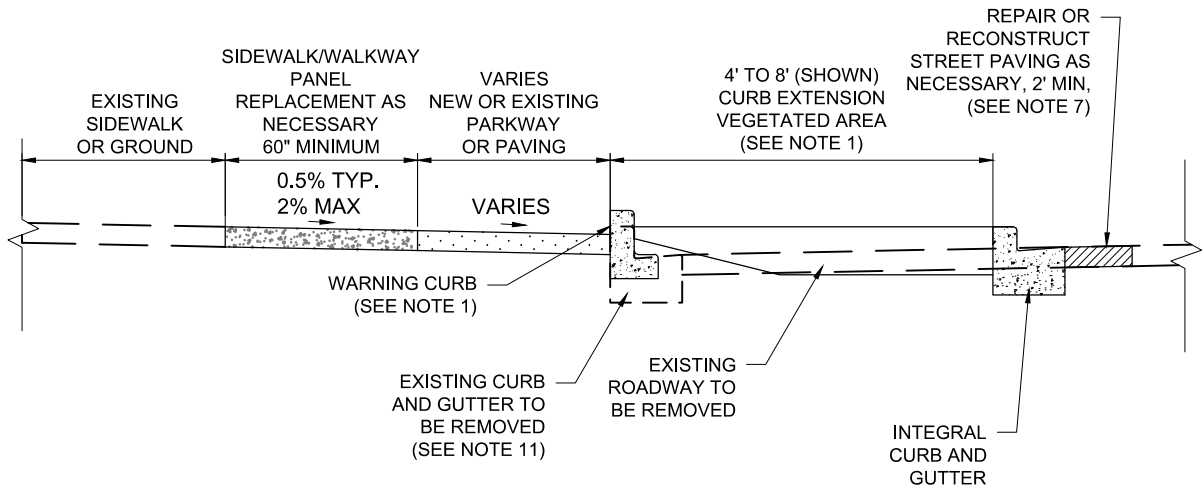

A2 TYPICAL SECTION AT CURB RETURN
 1,2 NON-WALKABLE WITH VEGETATION

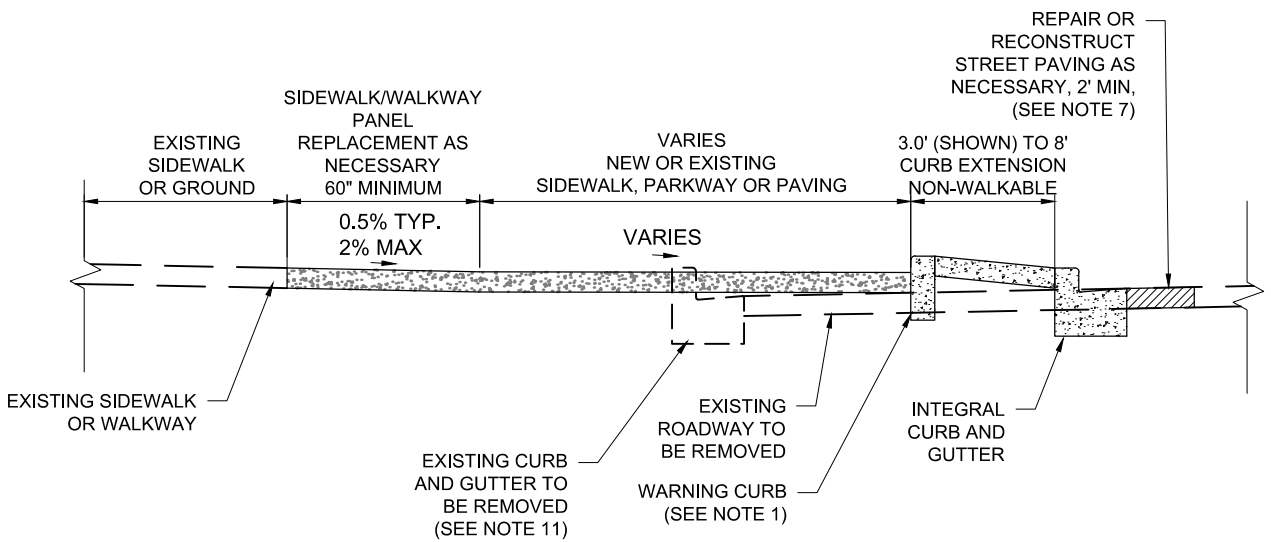

B TYPICAL SECTION AT CURB RETURN
 1 NON-WALKABLE WITH RAISED LANDSCAPED AREA

C:\Users\ccueva\Desktop\Carloss\SSDI\Supplemental Design\Final\Curb Extensions_BOE_DOT2.dwg
 3/31/2020 8:56 PM

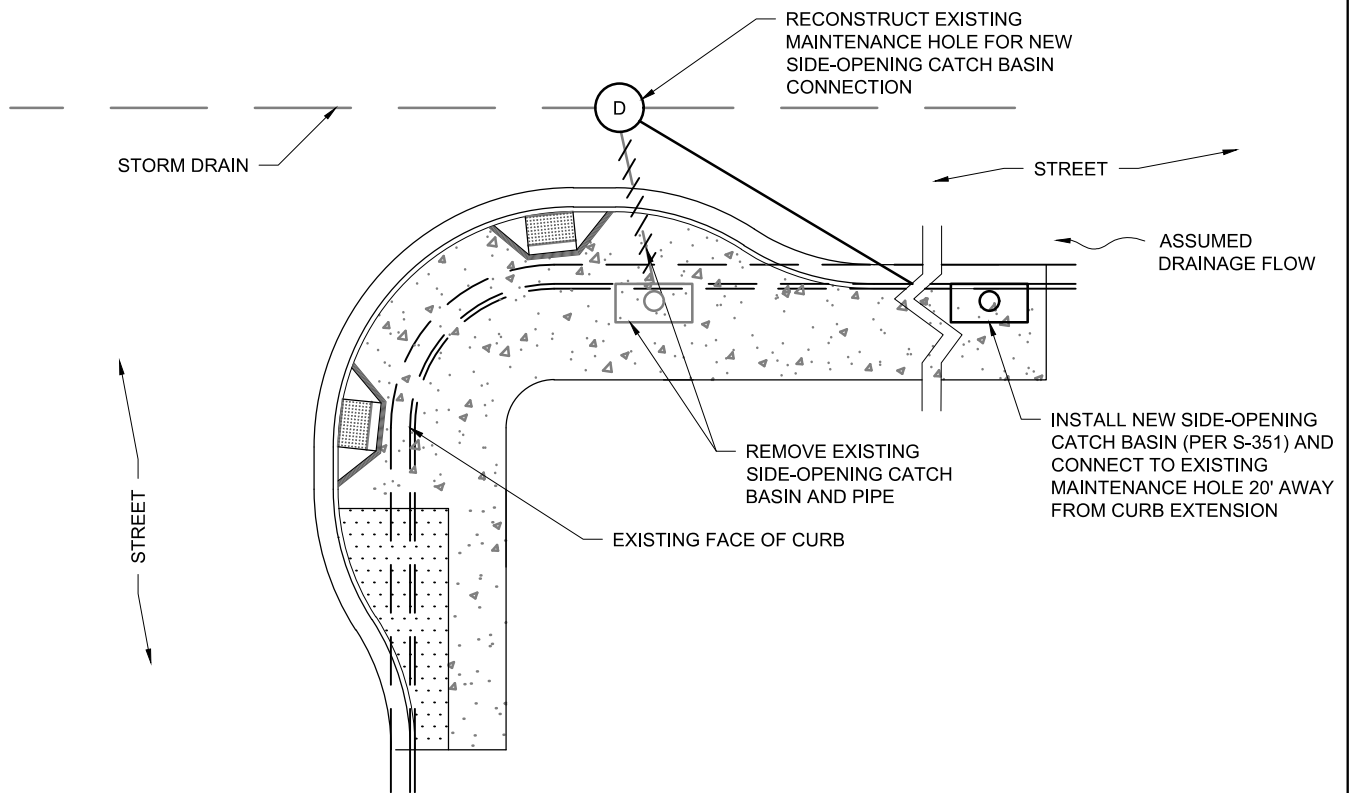

**STORM DRAIN CONNECTION TYPE 1
CONNECTION TO EXISTING MAINTENANCE HOLE**

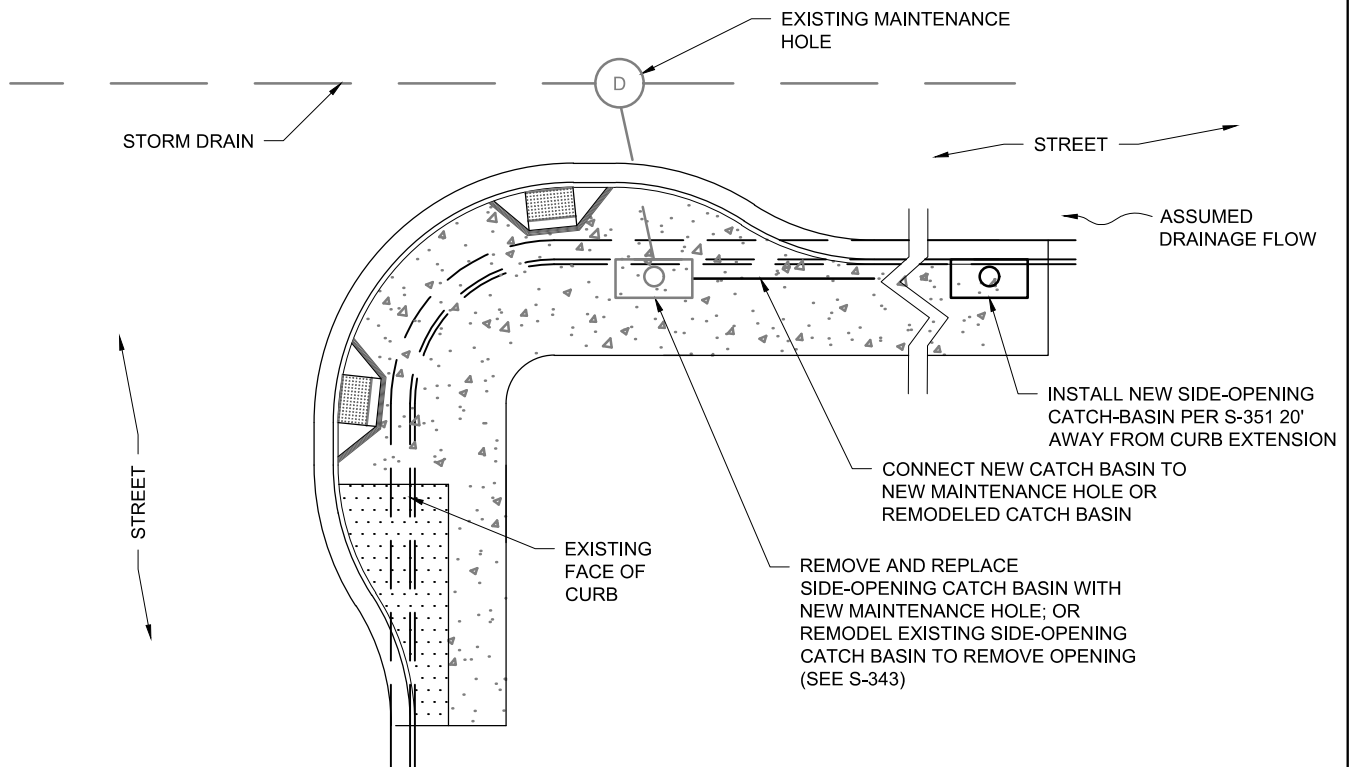

**STORM DRAIN CONNECTION TYPE 2
REMODEL EXISTING SIDE-OPENING CATCH BASIN**

C:\Users\ccueva\Desktop\SSDI\Supplemental Design\Final\Curb Extensions_BOE_DOT2.dwg
3/31/2020 8:56 PM

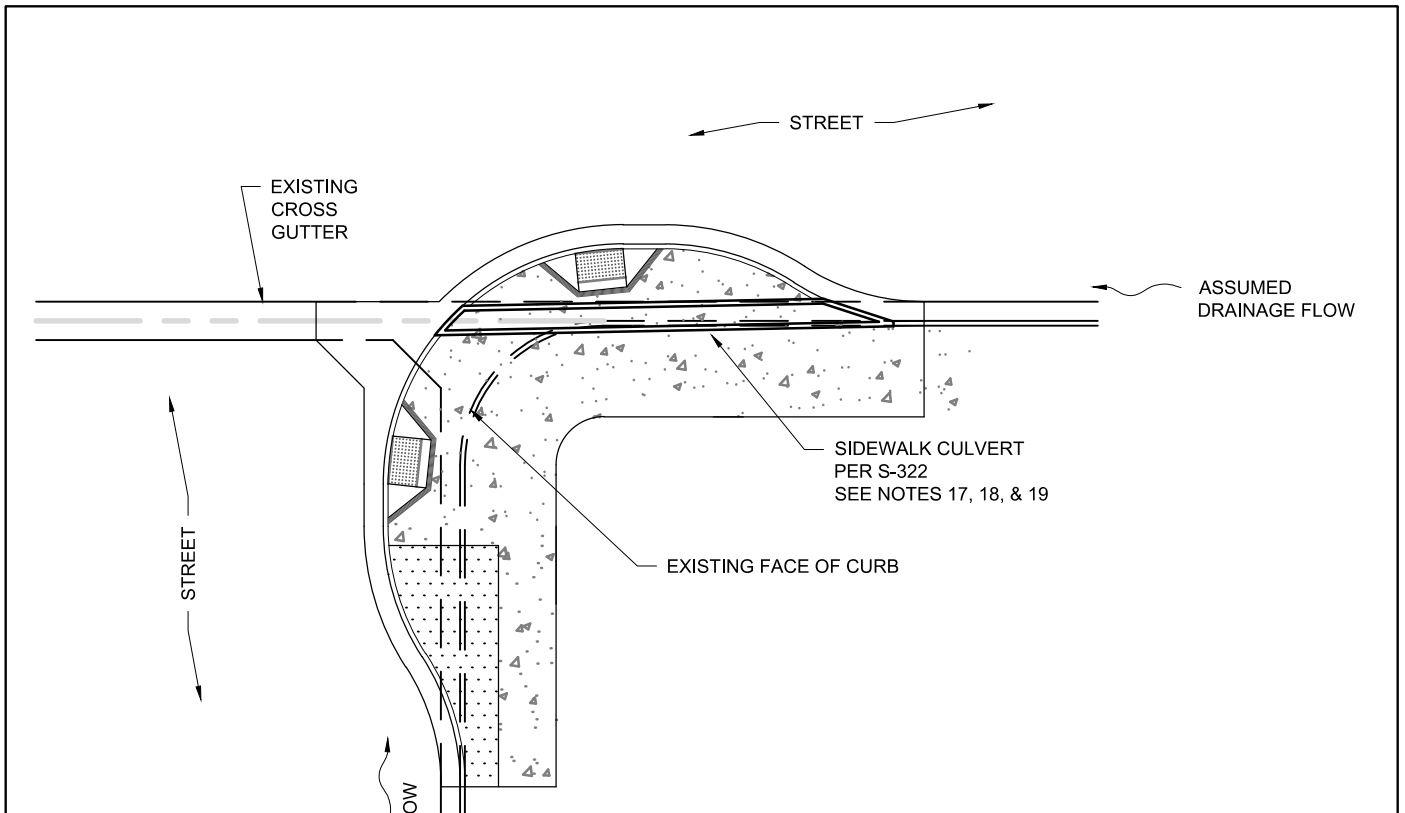

**TYPICAL LAYOUT
UPSTREAM CORNER**

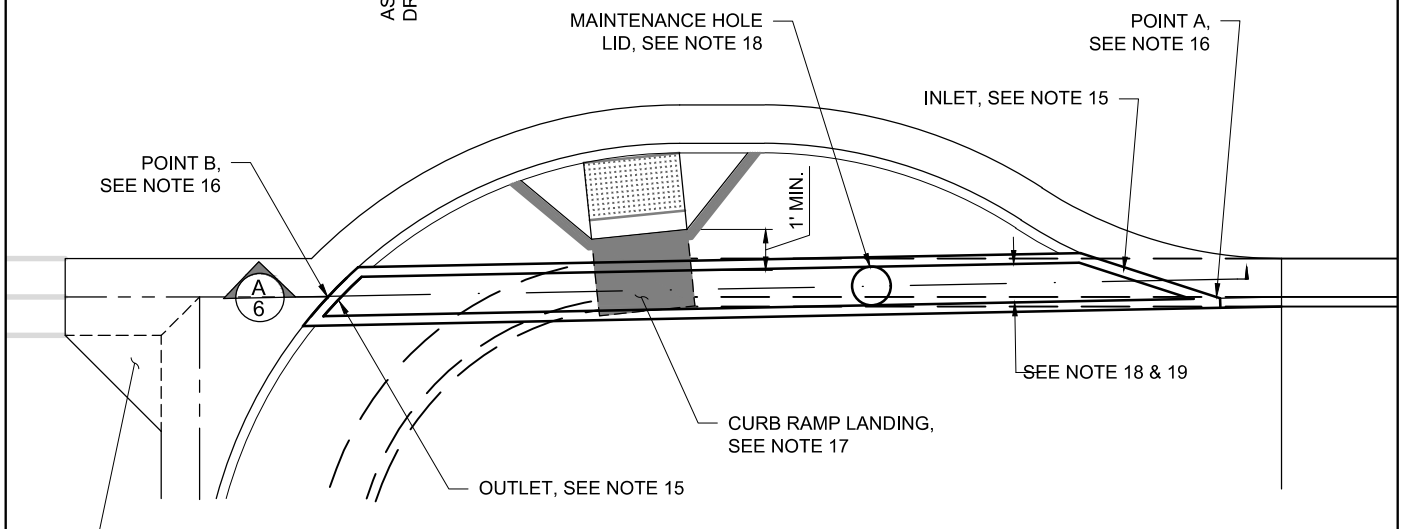

DETAIL

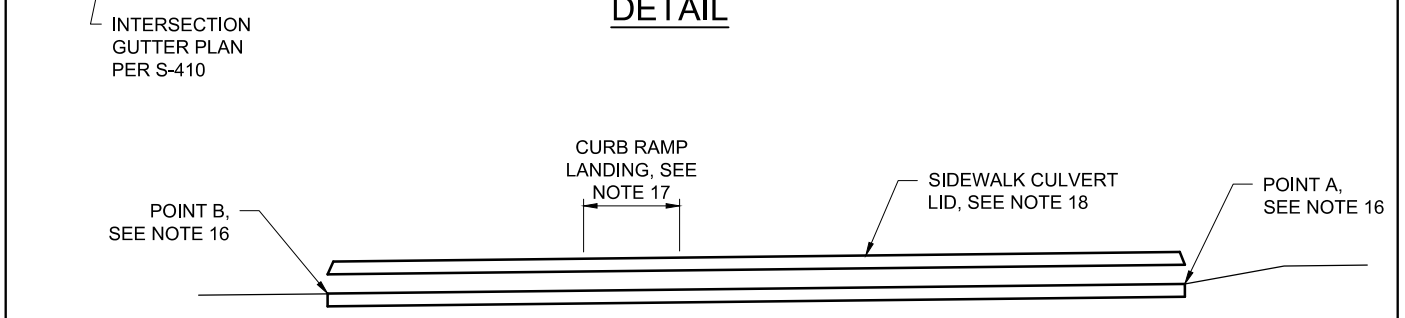

**A
6
SIDEWALK CULVERT SECTION**

C:\Users\ccueva\OneDrive\Desktop\SSDI\Supplemental Design\Final\Curb Extensions_BOE_DOT2.dwg
4/2/2020 7:29 AM

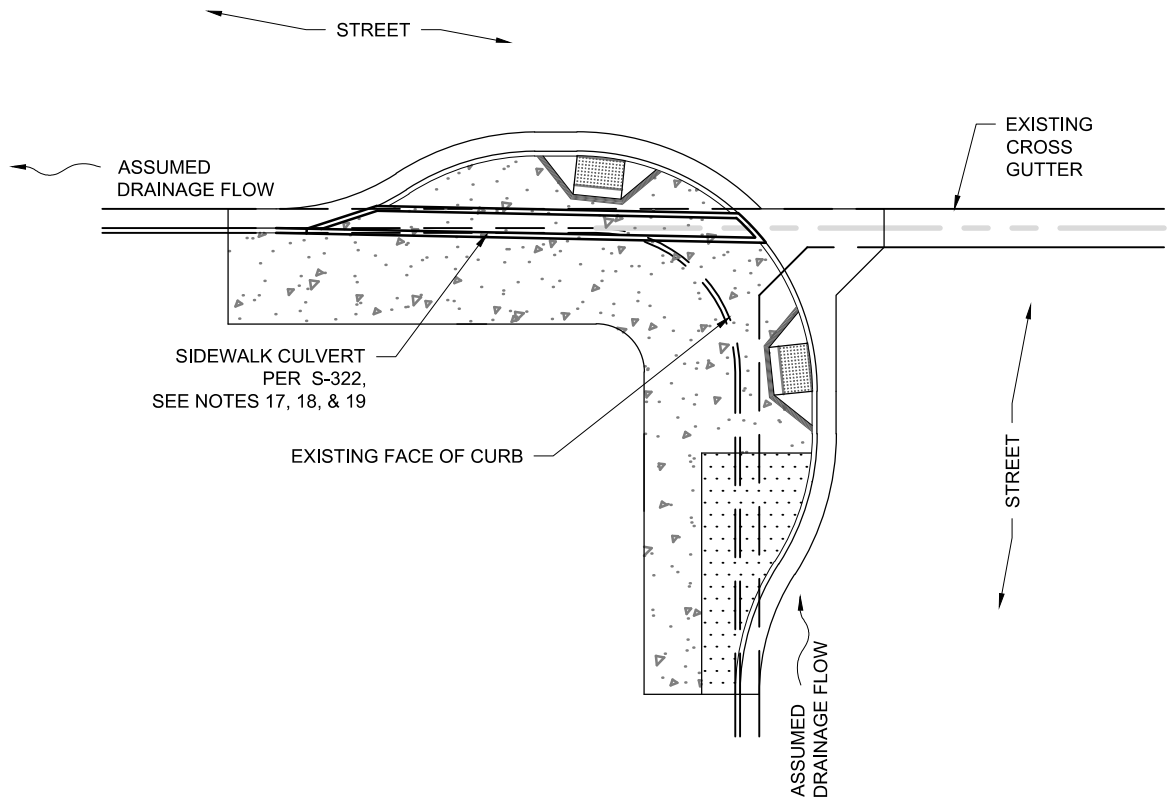

**TYPICAL LAYOUT
DOWNSTREAM CORNER**

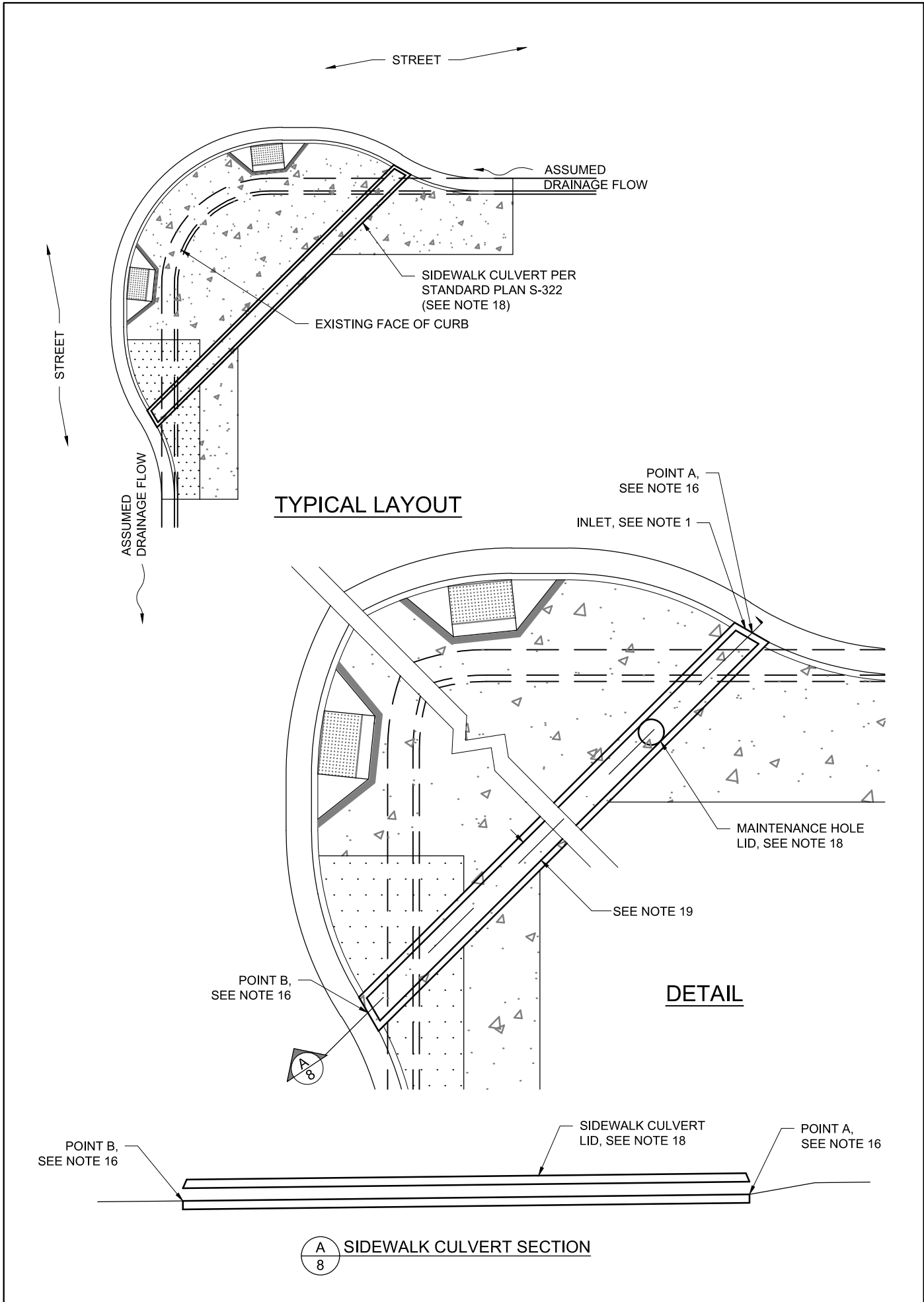

TYPICAL LAYOUT

DETAIL

A
8 **SIDEWALK CULVERT SECTION**

C:\Users\ccueva\OneDrive\Desktop\SSDI\Supplemental Design\Final\Curb Extensions_BOE_DOT2.dwg
4/2/2020 7:30 AM

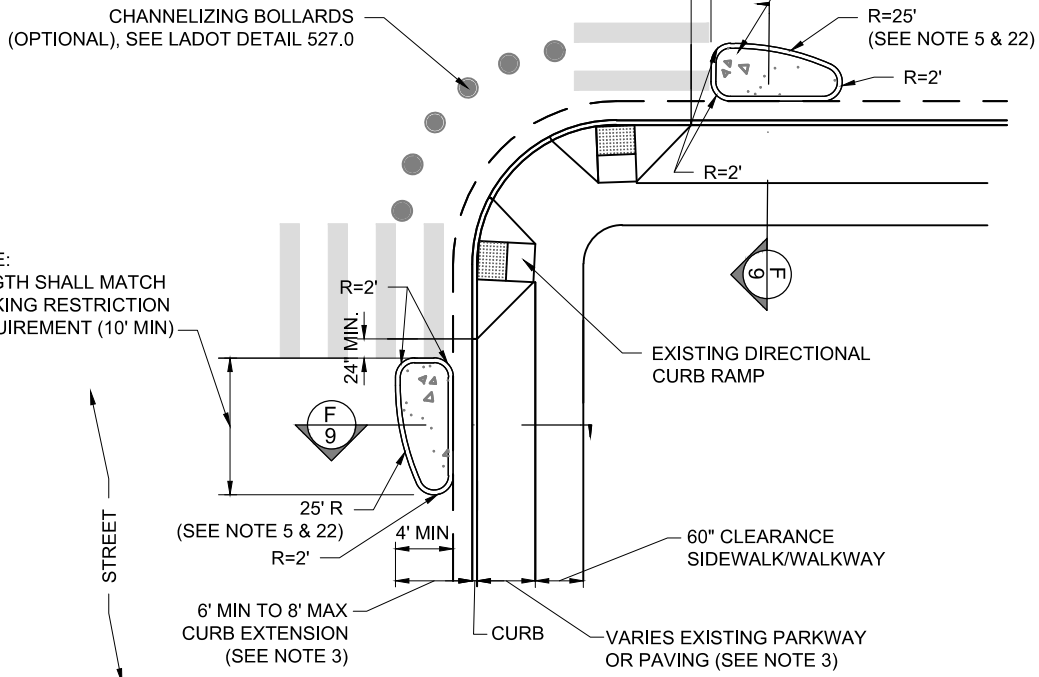

**TYPE 2 CURB EXTENSION
WITH DUAL DIRECTIONAL RAMPS**

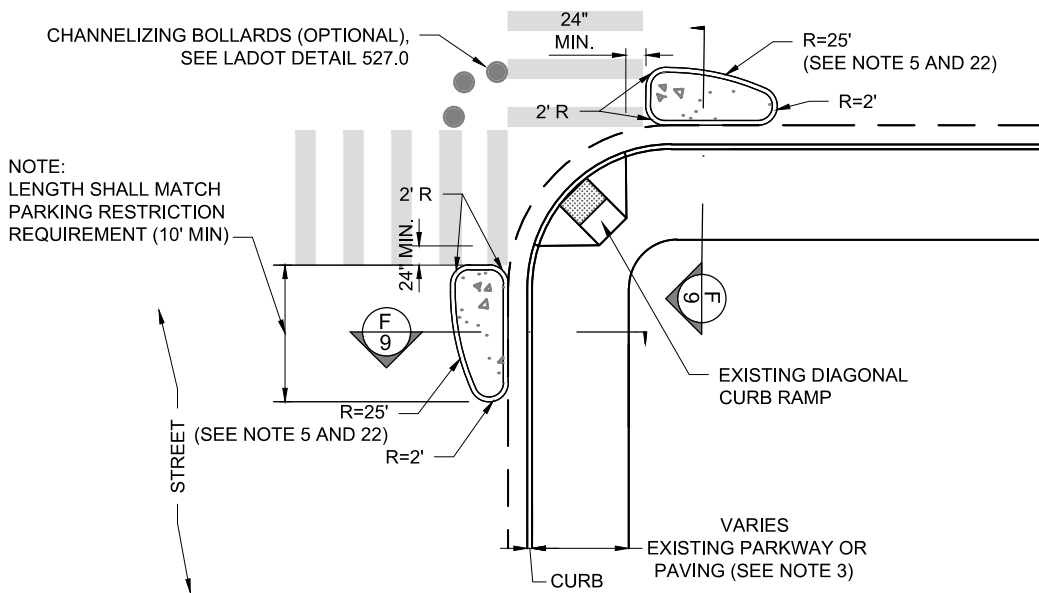

**TYPE 2 CURB EXTENSION
WITH DIAGONAL RAMP**

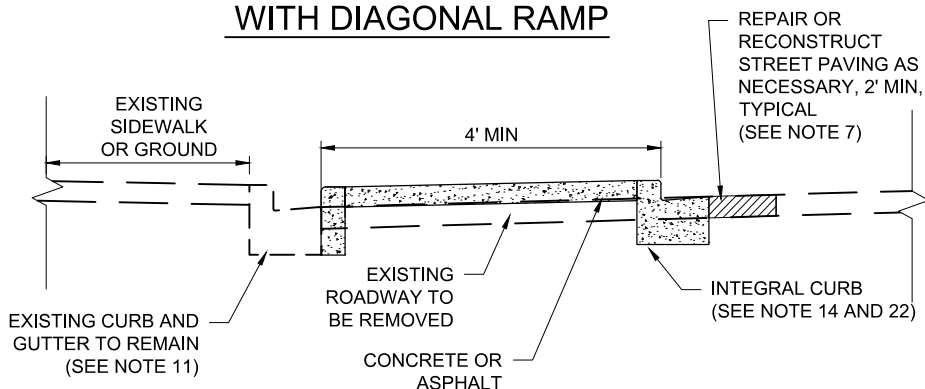

TYPICAL SECTION FOR TYPE 2 CURB EXTENSION

C:\Users\ccueva\Desktop\SSDI\Supplemental Design\Final\Curb Extensions_BOE_DOT2.dwg
4/2/2020 7:55 AM

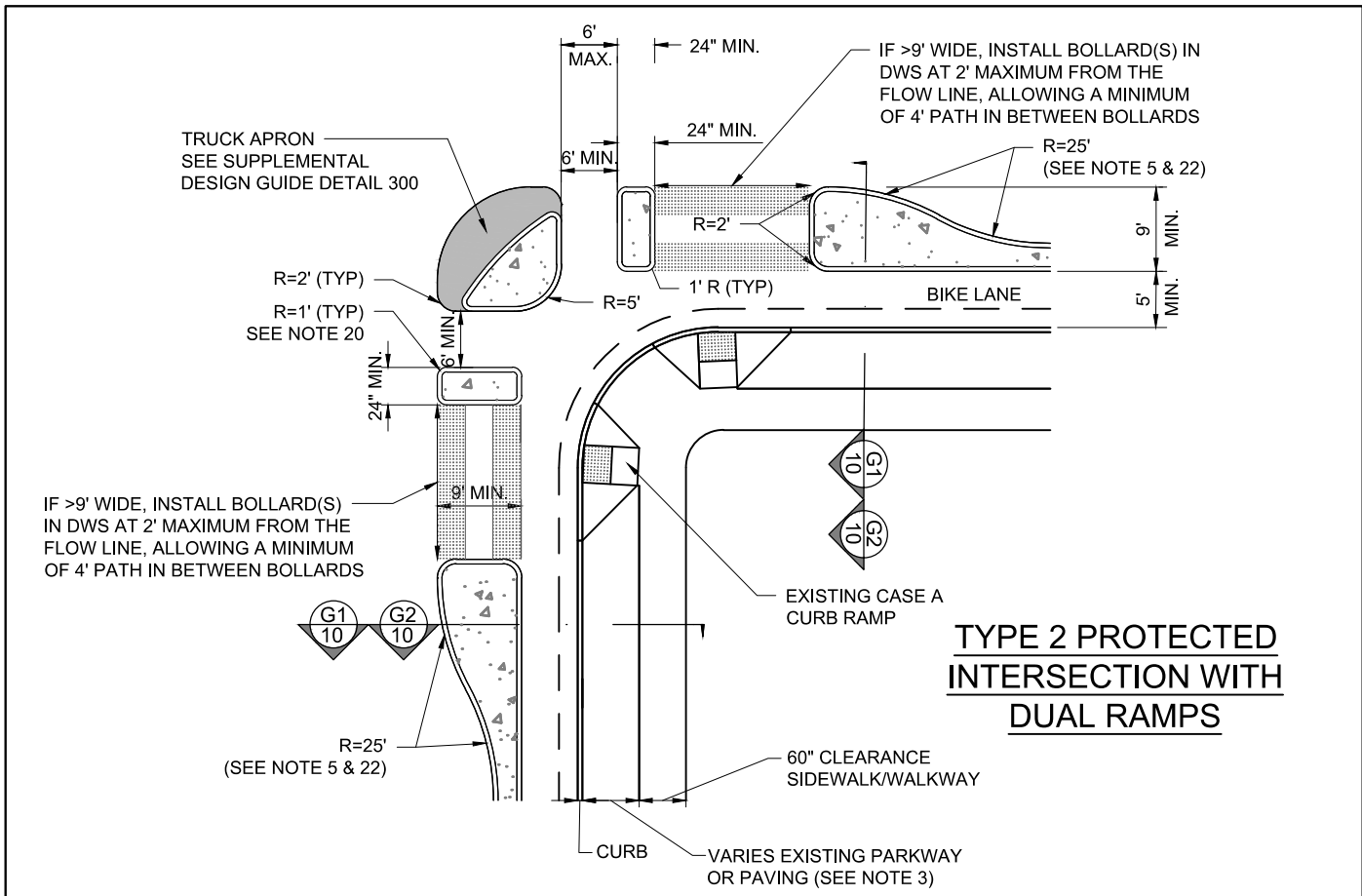

TYPE 2 PROTECTED INTERSECTION WITH DUAL RAMPS

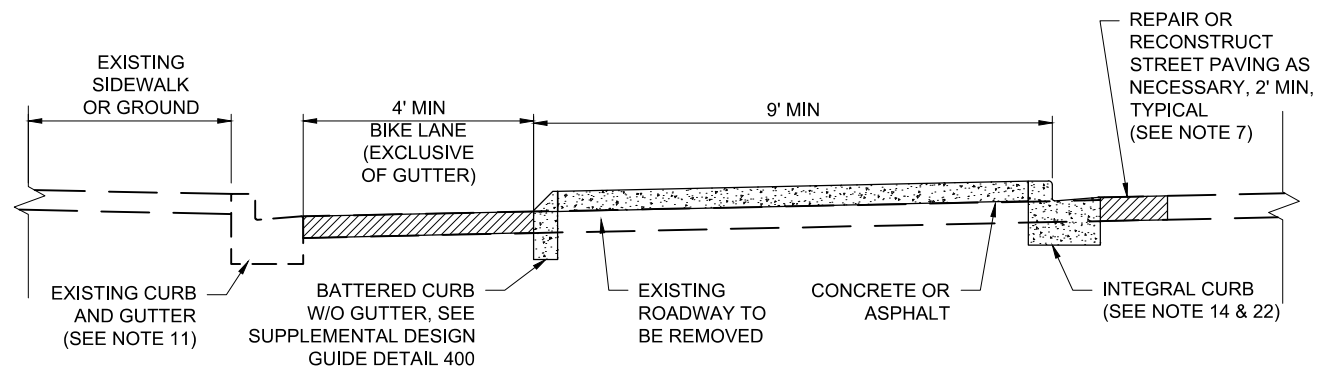

G1 TYPICAL SECTION FOR TYPE 2 PROTECTED INTERSECTION WITH EXISTING CURB AND GUTTER

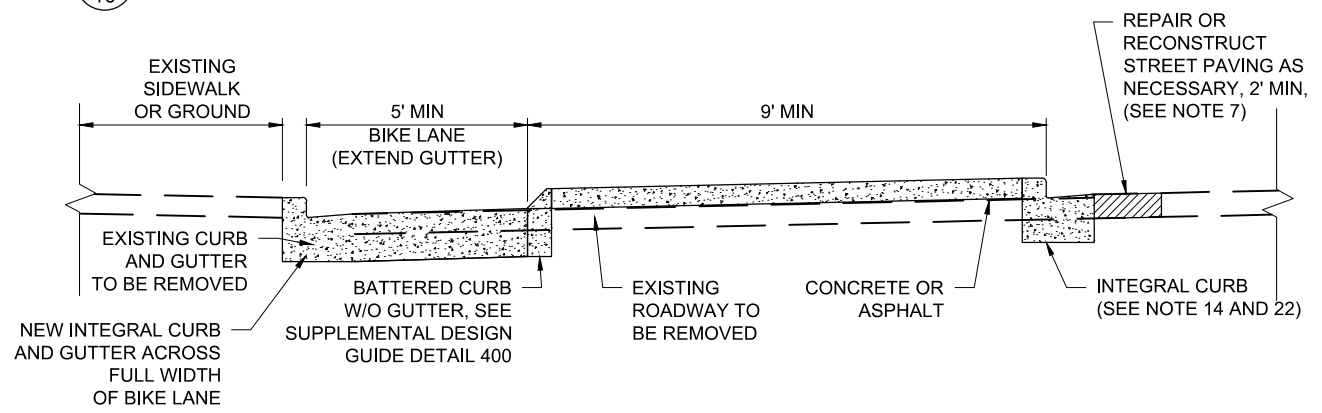

G2 TYPICAL SECTION FOR TYPE 2 PROTECTED INTERSECTION WITH REBUILT CURB AND GUTTER

C:\Users\ccueva\OneDrive\Desktop\SSDI\Supplemental Design\Final\Curb Extensions_BOE-040220.dwg
4/2/2020 5:25 PM

NOTES

1. SEE STANDARD PLAN S-484 FOR DETAILS INVOLVING VEGETATED STORMWATER CURB EXTENSIONS, WHICH MAY BE USED FOR SITUATIONS INVOLVING LANDSCAPED AREAS WITHIN A NON-WALKABLE AREA.
2. AREA SHALL BE PAVED AND ADHERE TO ADA REQUIREMENTS WHEN WALKABLE SLOPES CAN BE ACHIEVED. WHEN WALKABLE SLOPES ARE UNATTAINABLE, TREATMENTS SHALL BE INSTALLED TO DISCOURAGE PEDESTRIANS FROM WALKING IN THE AREA. NON-WALKABLE ALTERNATIVES INCLUDE VEGETATION AS SHOWN IN STANDARD PLAN S-484, RAISED PLANTING BEDS, OR FLUSH PLANTING BEDS WITH A VALLEY GUTTER. SEE CROSS SECTIONS A-1 FOR DETAILS ON ALTERNATIVES. INLETS MAY ALSO BE PROVIDED WITHIN THE NON-WALKABLE AREAS AND CURB OPENINGS MAY BE PROVIDED IN THE WARNING CURB TO ALLOW RUNOFF IN THE SIDEWALK TO REACH THESE INLETS.
3. WHERE STRUCTURALLY FEASIBLE AND NO PARKWAY OBSTRUCTIONS INTERFERE OR REQUIRE CURB FOR LATERAL SUPPORT, WIDTH OF TYPE 1 CURB EXTENSION SHALL REMOVE EXISTING CURB AND GUTTER TO INCORPORATE THE ADJACENT PARKWAY AND FOLLOW SECTION A-1. OTHERWISE THE TYPICAL SECTION MINIMUM WIDTH IS 3'-6" FROM INSIDE EXISTING AND NEW CURBS.
4. TRANSITION LENGTH SHALL VARY BASED THE WIDTH OF THE CURB EXTENSION AND THE CURB RADII USED FOR THE TRANSITION.
5. A STREET SIDE CURB RADIUS OF 25' IS REQUIRED FOR COMPLETED STREET SWEEPING FROM GUTTER TO FACE OF CURB. A CURB RADIUS OF 10 FEET IS ALLOWABLE TO INCREASE AREA OF THE STORAGE/DETENTION AREA ONLY IF THE ADJACENT PROPERTY OWNER ASSUMES FULL RESPONSIBILITY FOR ANY GUTTER MAINTENANCE AS MAY BE REQUIRED DUE TO LACK OF STREET SWEEPING.
6. SEE STANDARD PLAN S-442 FOR DETAILS INVOLVING CURB RAMPS. CHOOSE CURB RAMP TO FIT CONDITIONS. WHERE CURB EXTENSION HAS REVERSE SLOPE, RAMP SLOPE SHALL NOT BE LESS THAN 2% TOWARD THE STREET.
7. MODIFY THE EXISTING STREET PAVING AS NECESSARY TO RESTORE A SMOOTH TRANSITION AND STREET CROWN (STANDARD PLAN S-432, SIMILAR). MATCH PAVING MATERIALS AND THICKNESS, SEE S-410 FOR STANDARD CURBS & GUTTERS. ENSURE POSITIVE DRAINAGE IS PROVIDED.
8. CONSTRUCT CONCRETE SIDEWALK WHEN SPECIFIED ON PLAN. SIDEWALK MINIMUM CLEARANCE 60".
9. ALL CONCRETE & SIDEWALKS SHALL BE CLASS 520-C-2500 PORTLAND CEMENT CONCRETE. INSTALL CONTRACTION, EXPANSION AND WEAKENED PLANE JOINTS IN CONCRETE PER S-480 & S-430.
10. MINIMUM RELATIVE COMPACTION OF EARTHWORK UNDER NEW PAVING SHALL BE PER SSPWC. SEE S-480 FOR FURTHER REQUIREMENTS.
11. EXISTING CURB HEIGHT GENERALLY VARIES FROM 5 INCHES TO 8 INCHES.
12. A WALKABLE ALTERNATIVE IS THE PREFERRED OPTION WHEN ADA COMPLIANT GRADES CAN BE ACHIEVED. FACTORS AFFECTING THE ABILITY TO PRODUCE WALKABLE GRADES INCLUDE THE ROADWAY CROSS SLOPE, EXISTING CURB HEIGHT, EXISTING GROUND OR SIDEWALK ELEVATION, AND THE WIDTH OF THE SIDEWALK EXTENSION. SLOPES NOT TO EXCEED 2%.
13. WHERE GRADES CAN BE MODIFIED, TYPE C CURB AND GUTTER WITH A STANDARD CURB HEIGHT SHALL BE INSTALLED. NEW CURB MAY BE INSTALLED WITH A CURB HEIGHT BETWEEN 5 TO 8 INCHES TO CREATE WALKABLE SLOPES ON THE CURB EXTENSION. WHERE APPROVED BY BUREAU OF ENGINEERING, A TYPE C (MODIFIED) DEPRESSED CURB AND GUTTER MAY BE UTILIZED IF A REDUCED CURB HEIGHT PRODUCES A WALKABLE SLOPE OF 2% OR LESS. CURB HEIGHTS LESS THAN 5" REQUIRE APPROVAL OF CITY ENGINEER.
14. OVERALL CURB HEIGHT WILL VARY BASED ON EXISTING GRADES AND CURB REVEALS. ENSURE THAT CURB DEPTH EXTENDS AT LEAST 8 INCHES BELOW FINISHED GRADE.
15. THE INLET AND OUTLET SHALL BE DESIGNED PER STANDARD PLAN S-322 (STEEL) OR STANDARD PLAN DL-2327 (CONCRETE) DEPENDING ON THE CULVERT TOP MATERIAL. THE INLET OPENING SHALL BE AT LEAST AS WIDE AS THE CULVERT, BUT MAY BE WIDER BASED ON THE HYDRAULIC ANALYSIS (CHECK SPREAD DURING THE DESIGN STORM).
16. WARPING THE GUTTER (PER STD PLAN S-311) IS OPTIONAL, WHICH WILL RESULT IN A LOWER ELEVATION AT POINT A, EFFECTING THE LONGITUDINAL SLOPE (SEE NOTE #3).
17. THE CURB RAMP LANDING SHALL ADHERE TO STANDARD PLAN S-442. THE CULVERT TOP SHALL BE SLIP RESISTANT AND ADA COMPLIANT.
18. THE CULVERT TOP SHALL BE EITHER CONCRETE (PER STD PLAN S-320 AND DL-2327), STEEL (PER STD PLAN S-322), OR GRATED (AS APPROVED BY BOE). A MAINTENANCE HOLE LID MAY OPTIONALLY BE INSTALLED ALONG THE LENGTH OF THE CULVERT WHEN THE TOP IS CONCRETE. A CONCRETE CULVERT TOP WILL RESULT IN A LOWER ELEVATION AT POINT A, EFFECTING THE LONGITUDINAL SLOPE (SEE NOTE #3). A MAINTENANCE AGREEMENT SHALL BE IN PLACE PRIOR TO THE INSTALLATION OF CULVERT.
19. THE MINIMUM INSIDE WIDTH OF THE CULVERT IS 2 FEET. AT THE DISCRETION OF THE OFFICE ENGINEER, THE ABSOLUTE MINIMUM WIDTH THAT IS PERMITTED IS 1.5 FEET. A NARROWER WIDTH MAY BE NECESSARY TO CONSTRUCT THE CURB RAMP.
20. A 2 FOOT TYPICAL CURB RADIUS IS PREFERRED FOR ALL ISLAND CORNERS. A 1 FOOT RADIUS OR SQUARED CORNERS MAY BE USED TO MAXIMIZE THE FOOTPRINT AND IMPROVE CONSTRUCTABILITY OF ISLANDS LESS THAN 10 SQUARE FEET IN SIZE.
21. VALLEYS CREATED FROM REVERSE SLOPES SHALL BE DRAINED BACK TO THE CURB WHEN POSSIBLE TO AVOID PONDING ON THE CURB EXTENSION. THE USE OF A VALLEY GUTTER REQUIRES THE APPROVAL OF THE CITY ENGINEER. WHERE A CROSS SLOPE OF 2% OR LESS IS NOT FEASIBLE, A NON-WALKABLE SURFACE MUST BE PROVIDED.
22. WHERE DRAINAGE IS A CONCERN AS INSTRUCTED BY THE CITY ENGINEER, TYPE C CURB & GUTTER SHALL BE INSTALLED.

C:\Users\ccueva\Desktp\Carlota\SSDI\Supplemental Design\Final\Curb Extensions_BOE_DOT2.dwg
4/2/2020 7:32 AM

MOUNTABLE TRUCK APRON

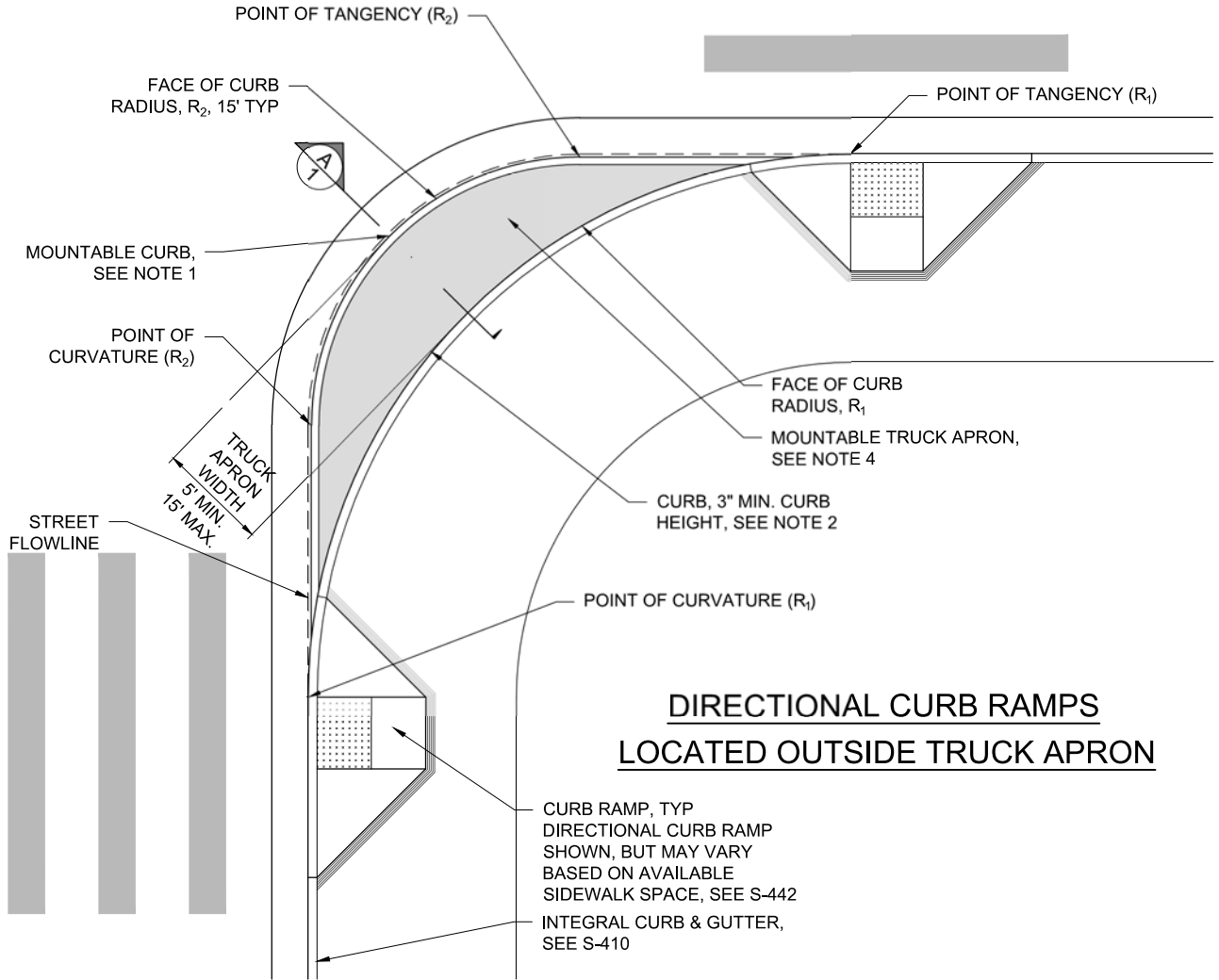

DIRECTIONAL CURB RAMPS LOCATED OUTSIDE TRUCK APRON

CURB RAMP, TYP
 DIRECTIONAL CURB RAMP
 SHOWN, BUT MAY VARY
 BASED ON AVAILABLE
 SIDEWALK SPACE, SEE S-442
 INTEGRAL CURB & GUTTER,
 SEE S-410

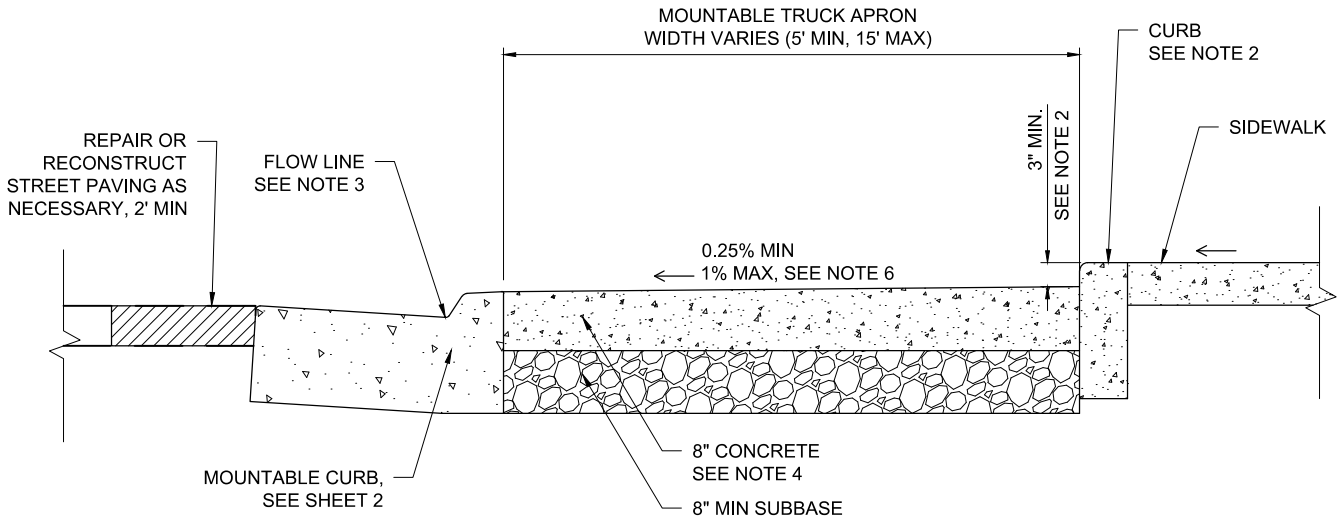

A APRON SECTION
 1 1 TIER APRON

TRUCK APRONS

SUPPLEMENTAL
 DESIGN GUIDE

DETAIL 300

SHEET 1 OF 6

MOUNTABLE TRUCK APRON

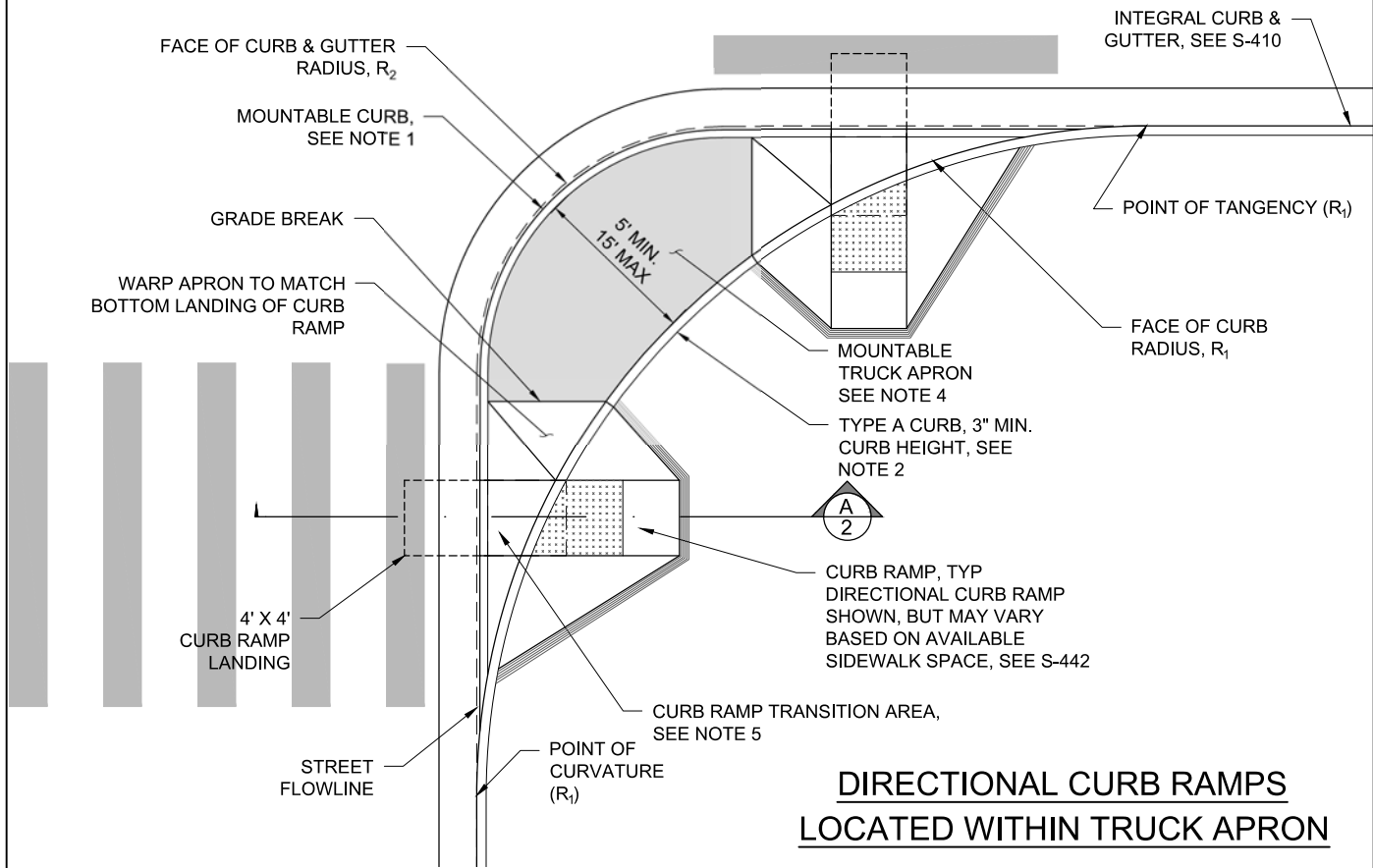

DIRECTIONAL CURB RAMPS LOCATED WITHIN TRUCK APRON

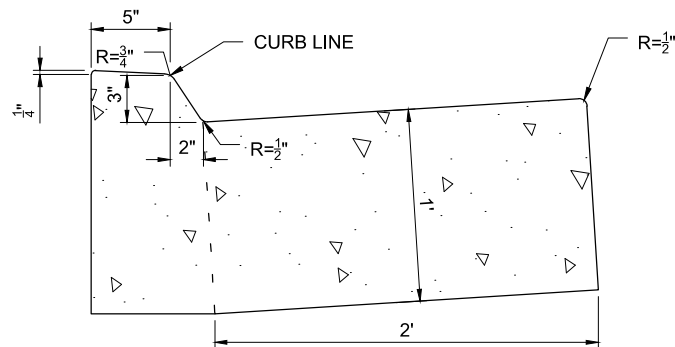
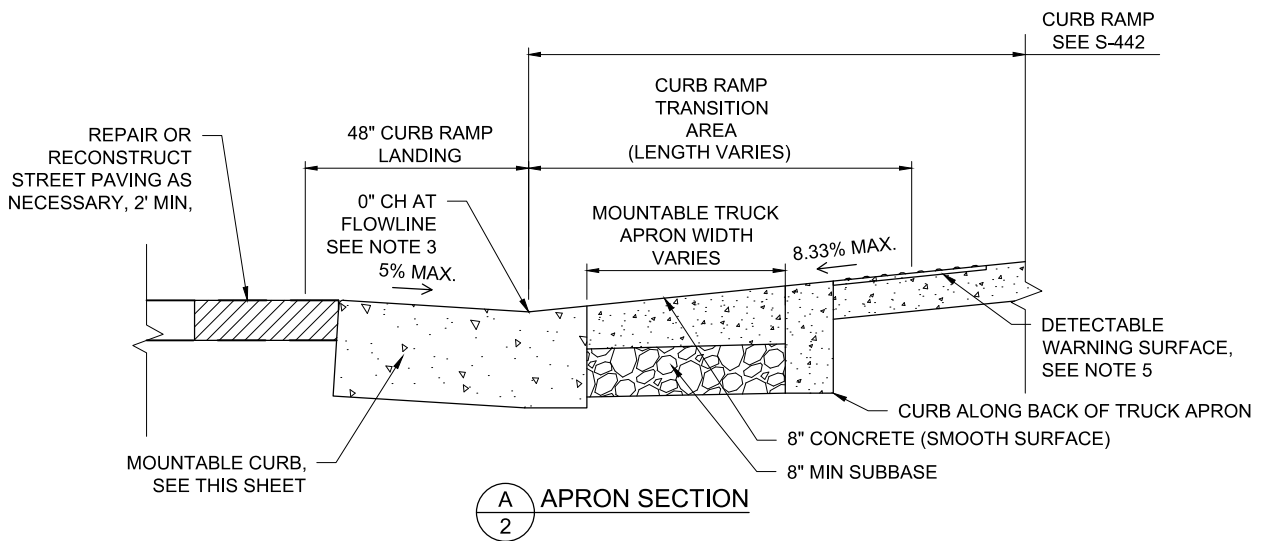

MOUNTABLE CURB AND CONCRETE PAVEMENT

C:\Users\ccueva\Desktop\Cartosa\SSDI\Supplemental Design\Final\Truck Apron + Pillow_BOE2.dwg
 3/31/2020 9:09 PM

MOUNTABLE TRUCK PILLOW

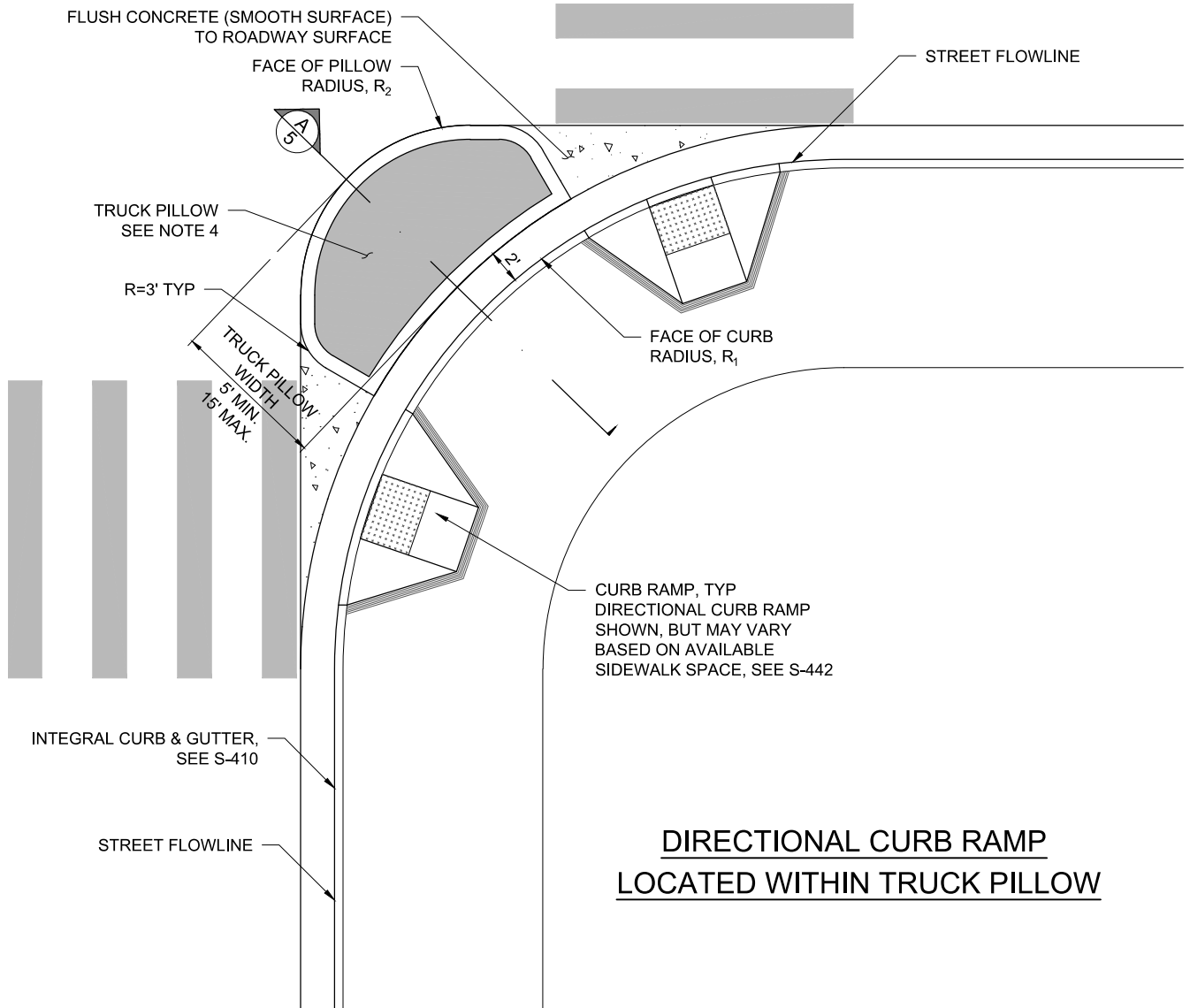

DIRECTIONAL CURB RAMP LOCATED WITHIN TRUCK PILLOW

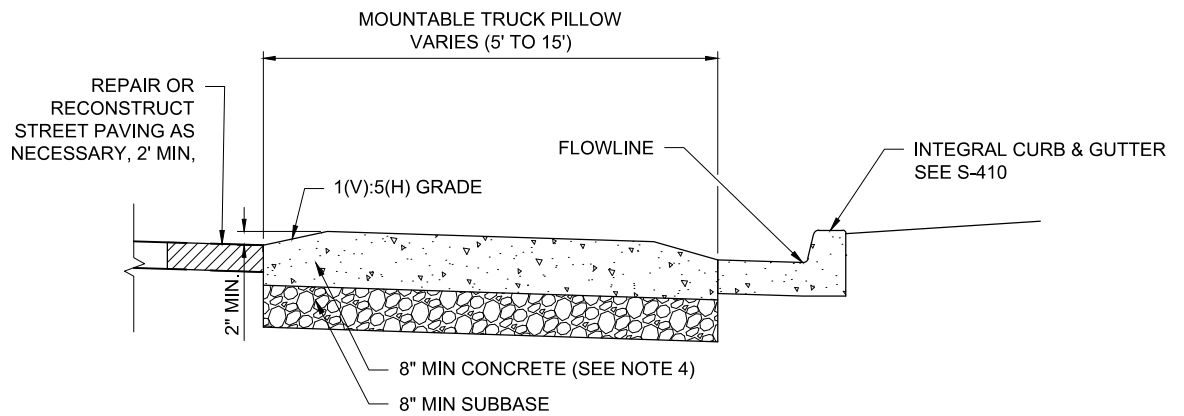

A
5
PILLOW SECTION

C:\Users\ccueva\Desktop\Carloss\SSDI\Supplemental Design\Final\Truck Apron + Pillow_BOE2.dwg
3/31/2020 9:09 PM

MOUNTABLE TRUCK PILLOW

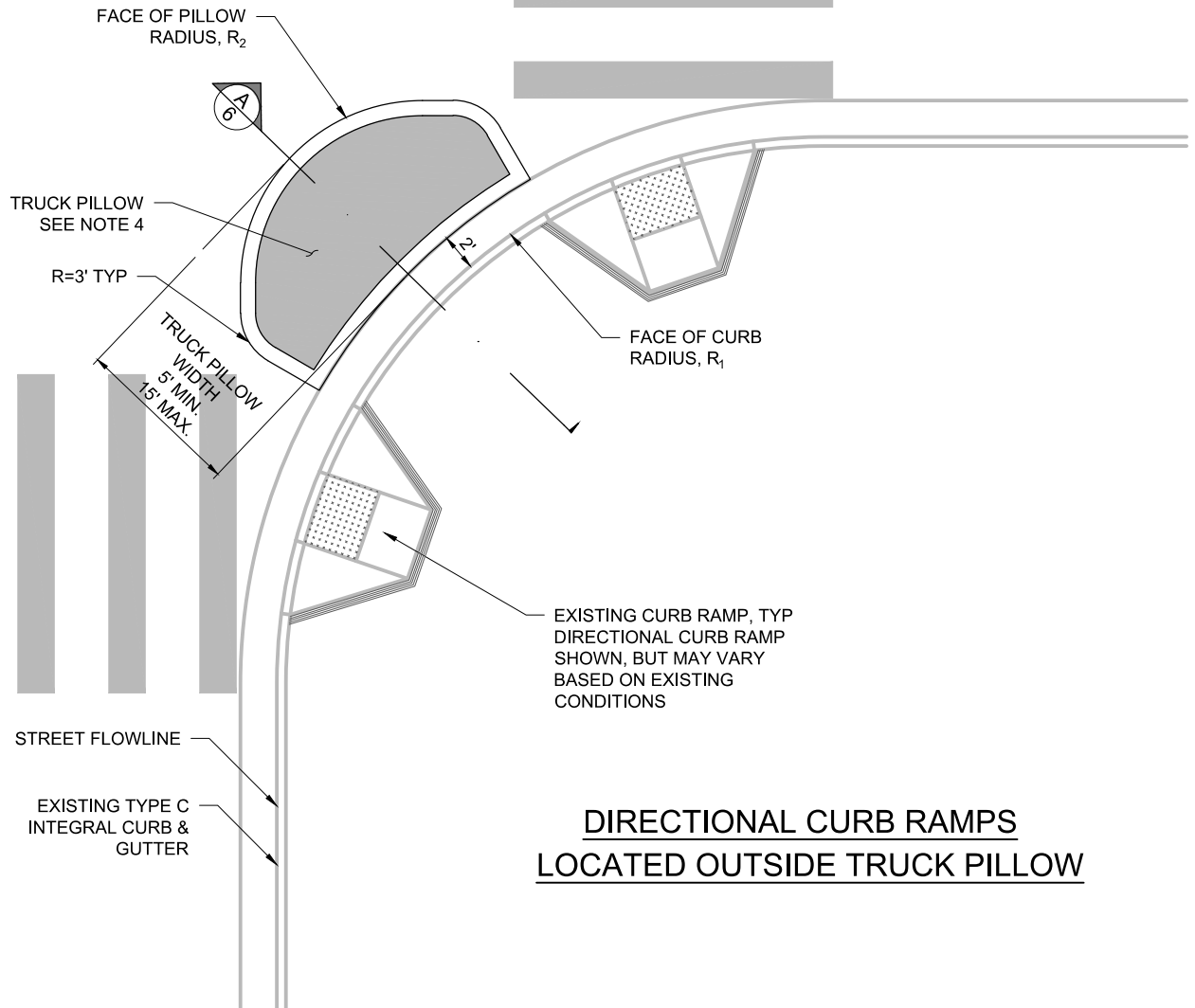

DIRECTIONAL CURB RAMPS LOCATED OUTSIDE TRUCK PILLOW

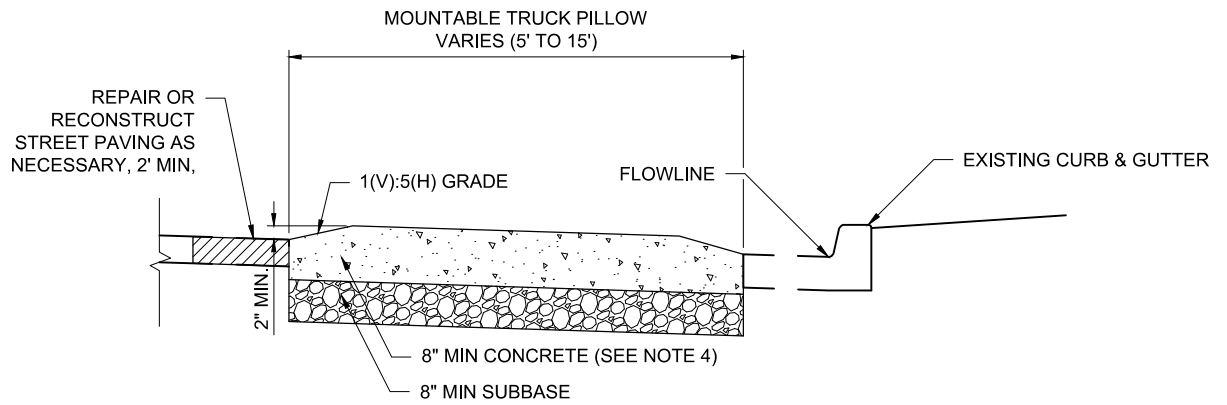

A
6 PILLOW SECTION

C:\Users\ccueva\Desktop\Carloss\SSDI\Supplemental Design\Final\Truck Apron + Pillow_BOE2.dwg 3/31/2020 9:09 PM

MOUNTABLE TRUCK PILLOW

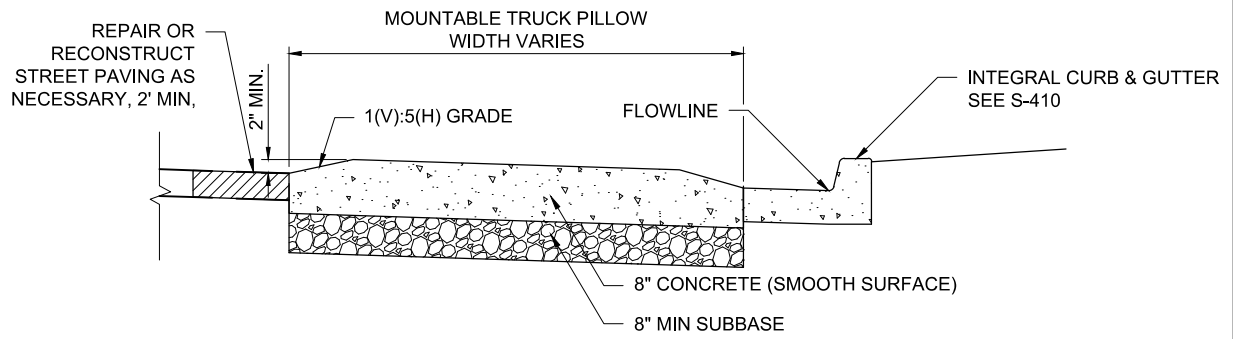
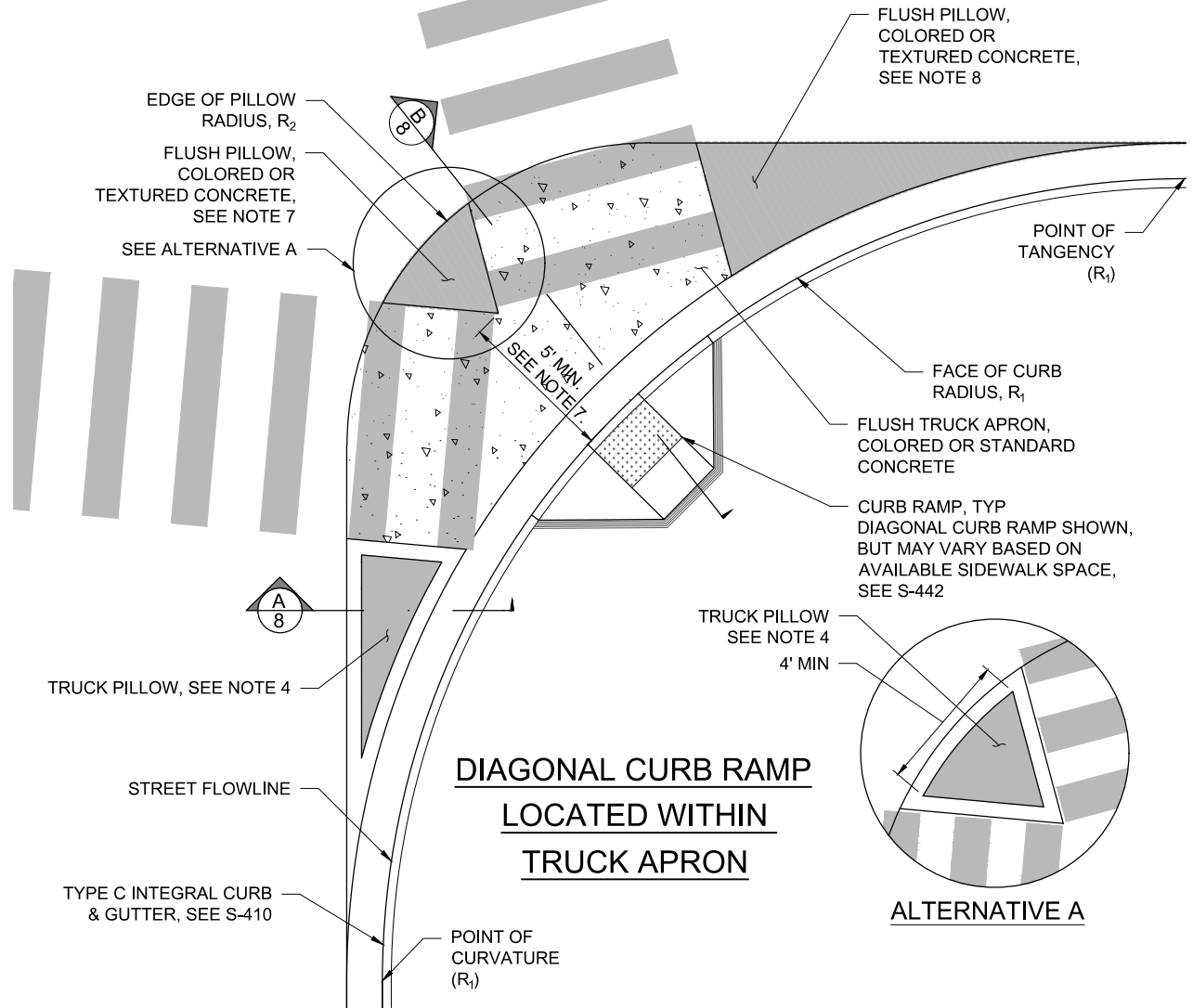

A
8
PILLOW SECTION

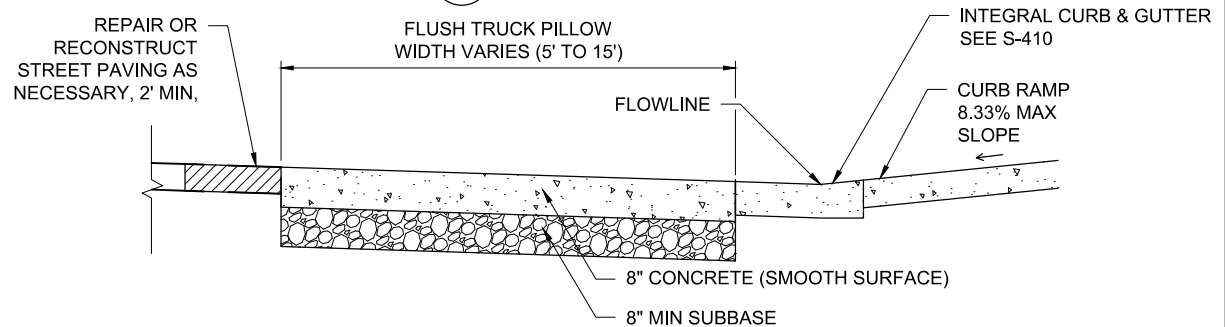

B
8
PILLOW SECTION

C:\Users\ccueva\OneDrive\Desktop\SSDI\Supplemental Design\FinalTruck Apron + Pillow_BOE2.dwg
4/2/2020 1:37 PM

NOTES:

1. THE HEIGHT OF THE MOUNTABLE CURB MAY VARY ALONG THE APRON RADIUS (R_2) WITH A MINIMUM HEIGHT OF 1 INCH AND A MAXIMUM HEIGHT OF 3 INCHES. A MINIMUM CURB HEIGHT OF AT LEAST 2 INCHES SHOULD BE PROVIDED AT THE POINT OF CURVATURE IF GRADING PERMITS. CURB HEIGHT MUST BE WARPED TO PROVIDE A 0 INCH CURB REVEAL APPROACHING CURB RAMPS. CURB HEIGHT WILL VARY BASED ON THE WIDTH OF THE APRON, THE CROSS SLOPE OF THE ROADWAY WITHIN THE INTERSECTION, AND THE OPPORTUNITIES TO MAKE GRADING CHANGES BEHIND THE CURB WITHIN THE SIDEWALK AREA.
2. THE HEIGHT OF THE FULL HEIGHT CURB VARIES ALONG THE BACK OF THE APRON (R_1) BUT SHALL BE A MINIMUM OF 3 INCHES (5" PREFERABLE). CURB HEIGHTS LESS THAN 5" REQUIRE APPROVAL OF CITY ENGINEER, BUT SHALL NOT BE LESS THAN 3 INCHES.
3. THE STORMWATER FLOW LINE FOLLOWS THE APRON RADIUS (R_2). WHEN THE CROSS SLOPE OF THE ROADWAY WITHIN THE INTERSECTION DOES NOT ALLOW FOR POSITIVE DRAINAGE AROUND THE APRON RADIUS (R_2), A TRUCK PILLOW IS REQUIRED.
4. THE MOUNTABLE TRUCK APRON OR PILLOW SHALL BE DISTINCT FROM THE ADJACENT ROADWAY AND SIDEWALK. THE APRON OR PILLOW SHALL BE CONSTRUCTED WITH CONCRETE AND MAY USE INTEGRAL COLOR. SURFACE TEXTURE MAY BE APPLIED TO AREAS OUTSIDE OF THE CURB RAMP AND CROSSWALK. PAVEMENT MARKINGS, RAISED PAVEMENT MARKERS, AND / OR SURFACE APPLIED COLOR MAY BE APPLIED TO ACHIEVE CONSPICUITY.
5. THE CURB RAMP TRANSITION AREA TOWARDS THE BOTTOM OF THE CURB RAMP SHALL MEET STANDARD PLAN S-442 FOR CURB RAMPS. THE LANDING FOR THE CURB RAMPS WILL BE LOCATED BEYOND THE STREET FLOWLINE. IF THE CURB RAMP IS PARTIALLY LOCATED WITHIN THE TRUCK APRON OR PILLOW, THE ACCESSIBLE PATH OF TRAVEL SHALL BE SMOOTH AND THE DETECTABLE WARNING SURFACE SHALL BE PLACED OUTSIDE OF THE TRUCK APRON OR PILLOW AREA.
6. THE TRUCK APRON IS SHOWN SLOPING TOWARDS THE MOUNTABLE CURB. THE TRUCK APRON MAY BE DESIGNED TO INSTEAD SLOPE TOWARDS THE SIDEWALK WITH THE SAME MINIMUM AND MAXIMUM SLOPES IF POSITIVE DRAINAGE CAN BE MAINTAINED AND DISCHARGED BACK TO THE FLOWLINE BEYOND THE TRUCK APRON.
7. IF AT LEAST 4 FEET OF RAISED MOUNTABLE TRUCK APRON OR TRUCK PILLOW CAN BE PROVIDED, THEN ALTERNATIVE A SHOWING THE RAISED DESIGN SHOULD BE IMPLEMENTED.
8. THE TRUCK APRON ALONG THE TRAILING END OF THE MOUNTABLE TRUCK APRON (NEAR THE R_1 POINT OF TANGENCY) MAY BE CONSTRUCTED AS A RAISED MOUNTABLE TRUCK APRON INSTEAD OF FLUSH TRUCK APRON. THIS SHOULD BE CONSIDERED IF THE SPACE BETWEEN THE CROSSWALKS IS NOT SUFFICIENT TO CONSTRUCT THE ALTERNATIVE A DESIGN.

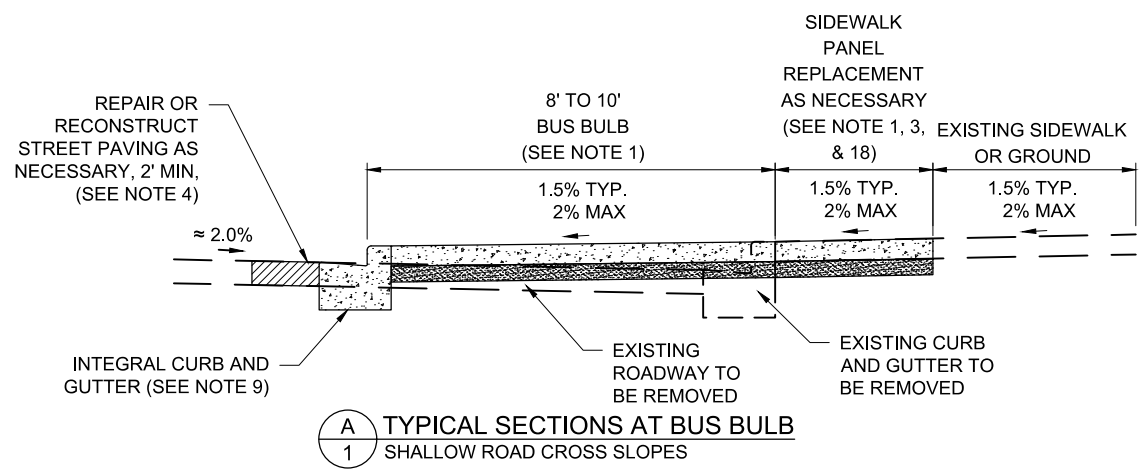
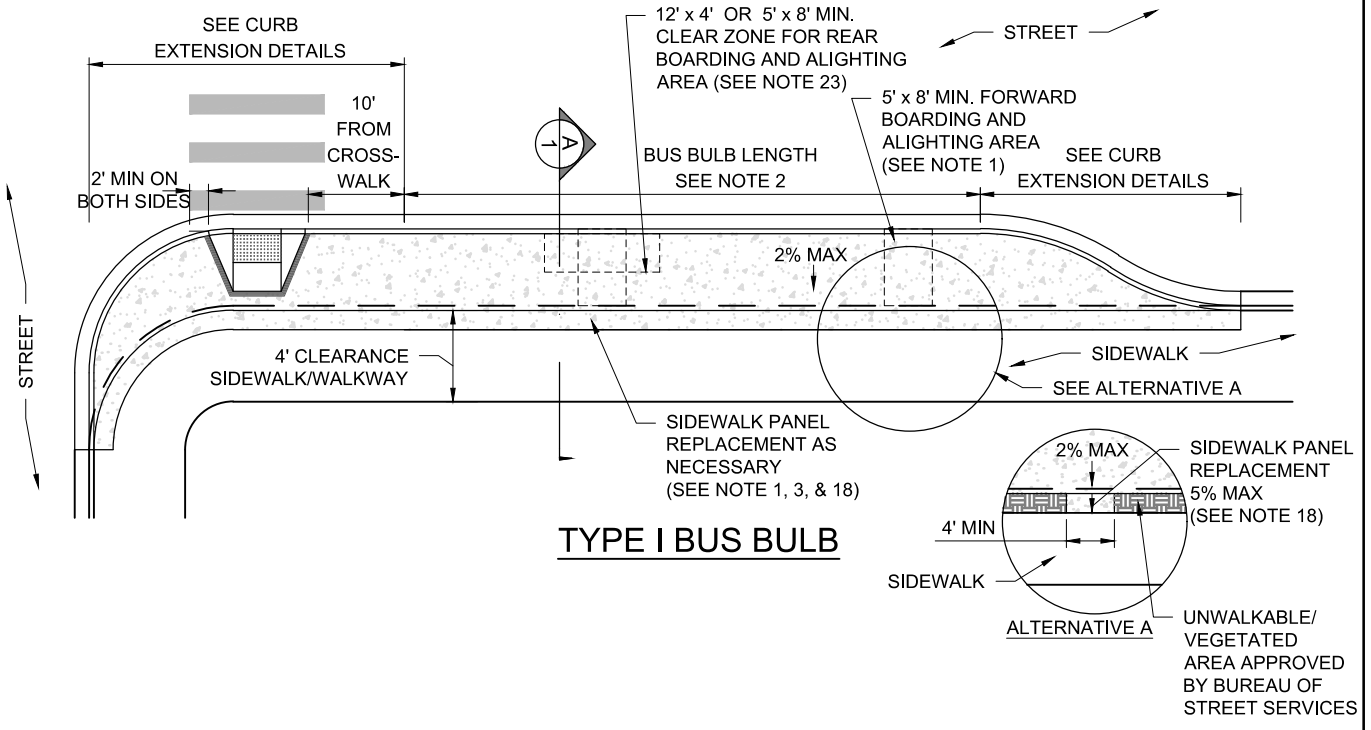

C:\Users\ccueva\Desktop\Cartosa\SSDI\Supplemental Design\Final\Bus Bulbs_BOE-040220.dwg
4/2/2020 8:37 PM

BUS BULBS

SUPPLEMENTAL DESIGN GUIDE

DETAIL 400

SHEET 1 OF 14

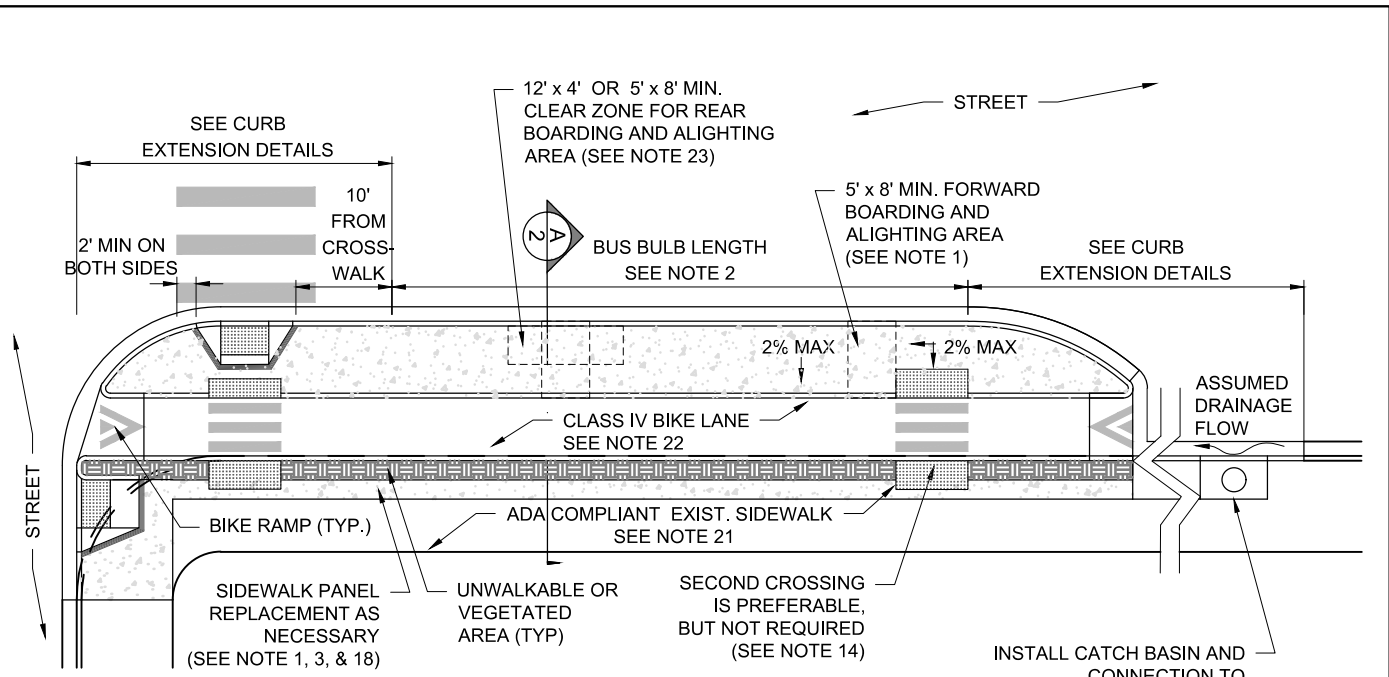

**TYPE II BUS BULB
SIDEWALK ELEVATION BIKE LANE**

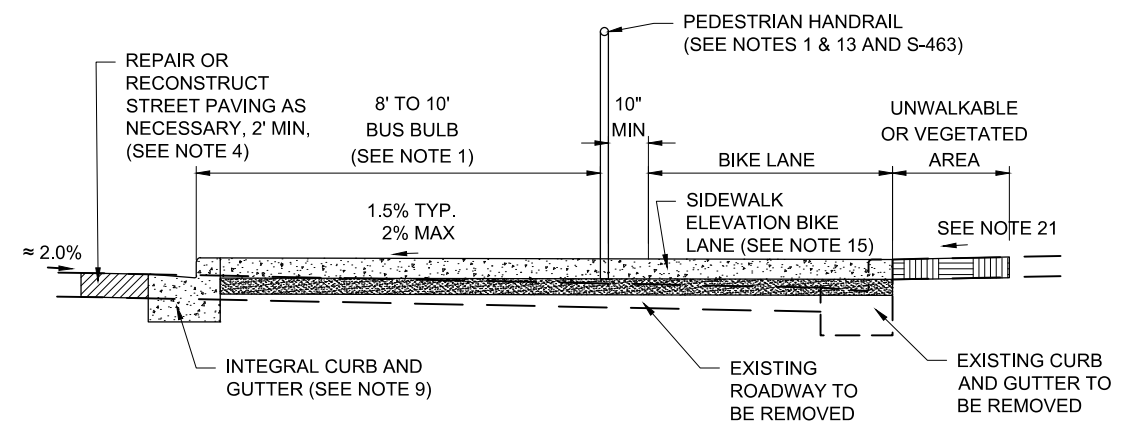

A TYPICAL SECTIONS AT BUS BULB
2 SHALLOW ROAD CROSS SLOPES

C:\Users\ccueva\OneDrive\Desktop\Carlota\SSD\Supplemental Design\Final\Bus Bulbs_BOE-040220.dwg
4/2/2020 8:46 PM

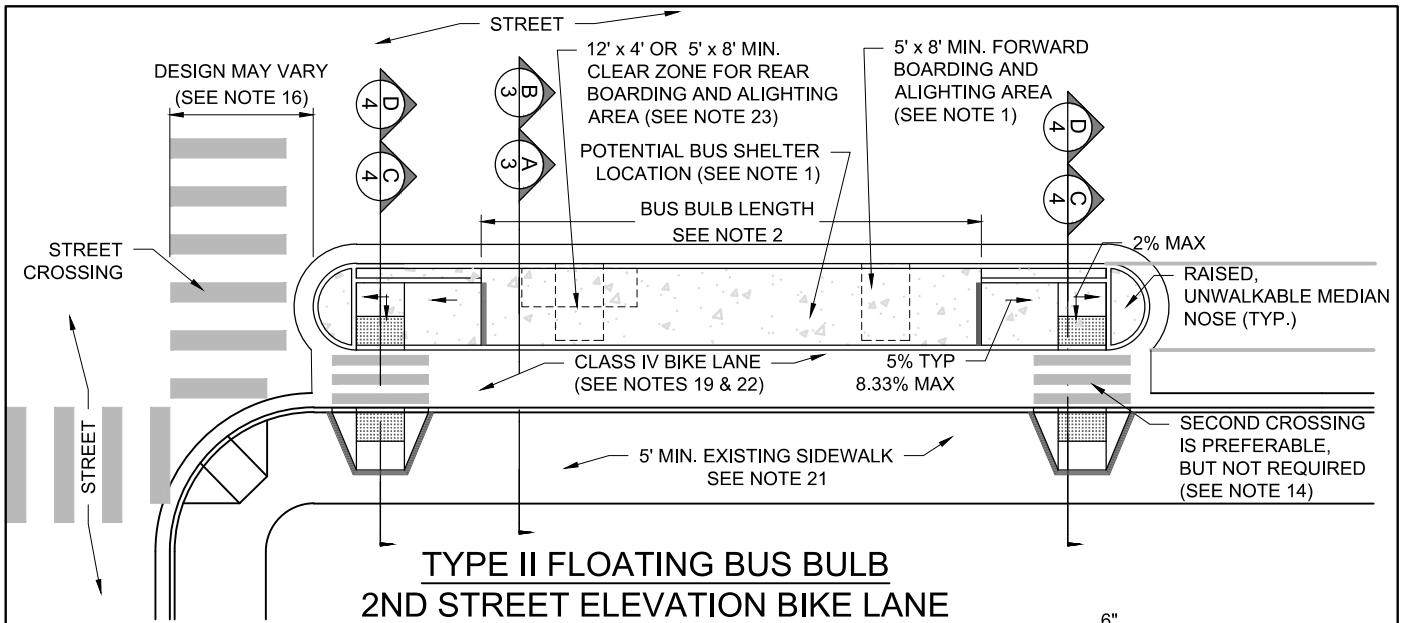

**TYPE II FLOATING BUS BULB
2ND STREET ELEVATION BIKE LANE
FROM STREET CROSSING**

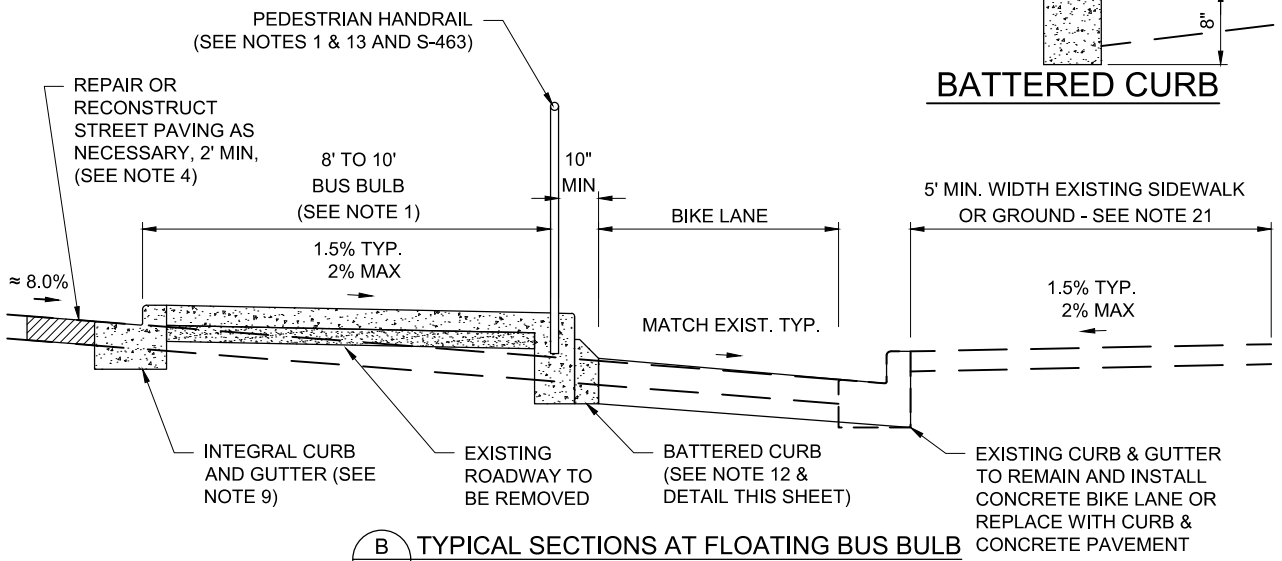
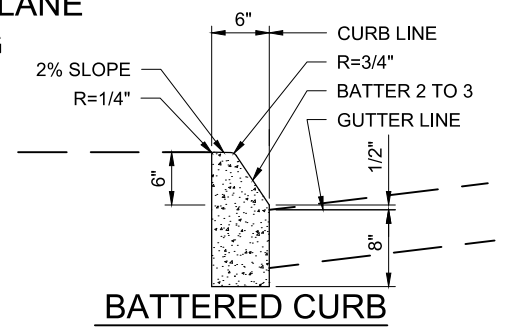

**B
3 TYPICAL SECTIONS AT FLOATING BUS BULB
STEEP ROAD CROSS SLOPES**

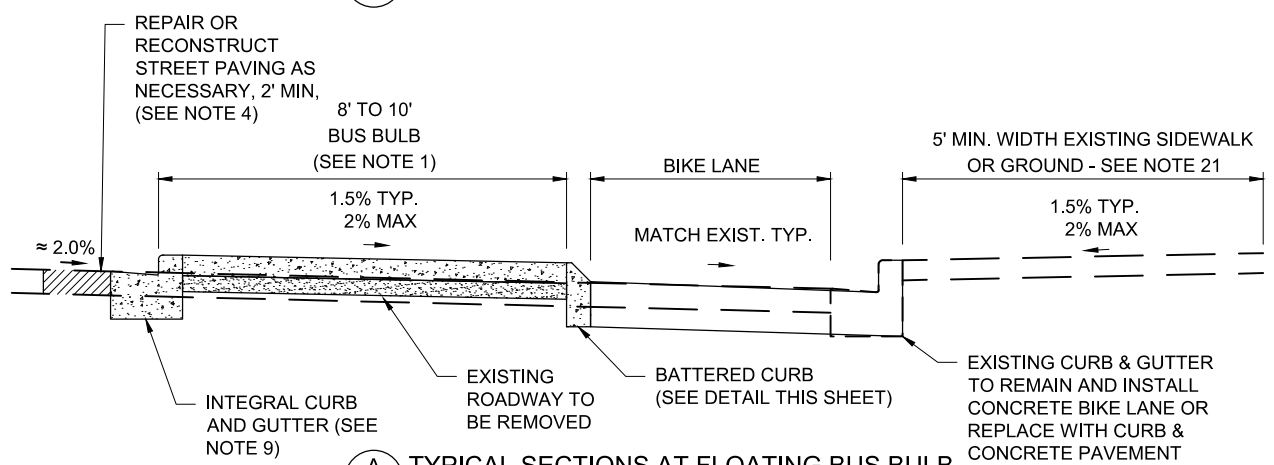

**A
3 TYPICAL SECTIONS AT FLOATING BUS BULB
SHALLOW ROAD CROSS SLOPES**

C:\Users\ccueva\Desktop\Carlota\SSDI\Supplemental Design\Final\Bus Bulbs_BOE-040220.dwg
4/2/2020 8:48 PM

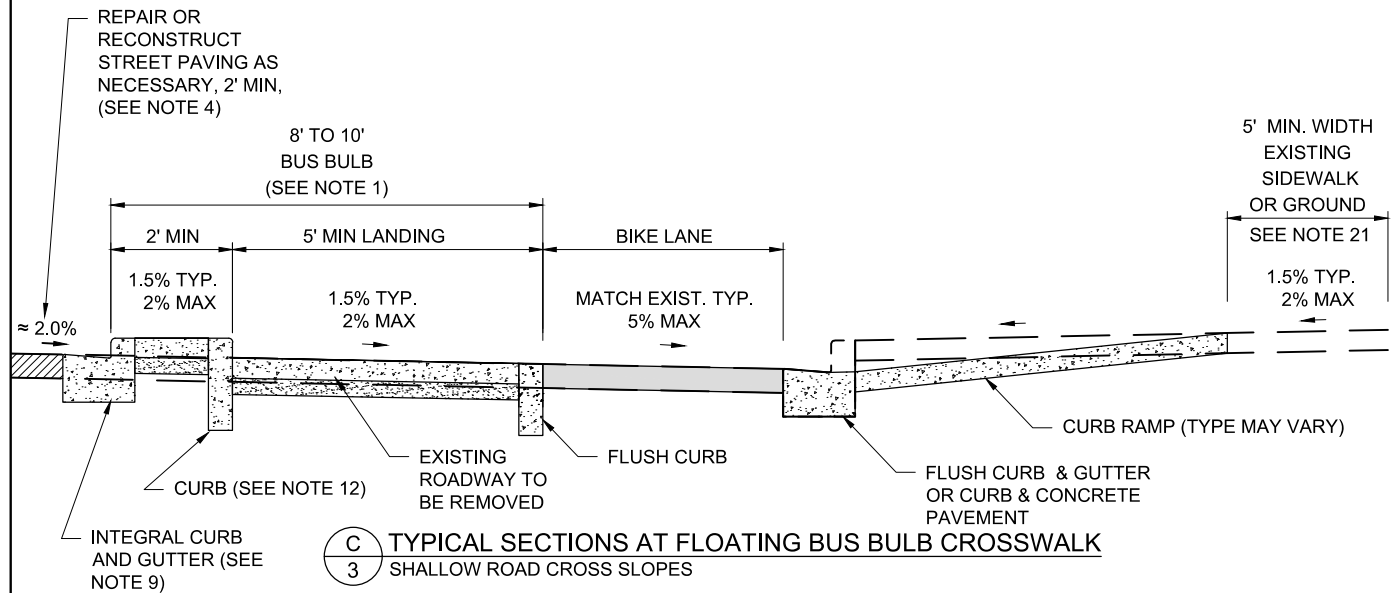
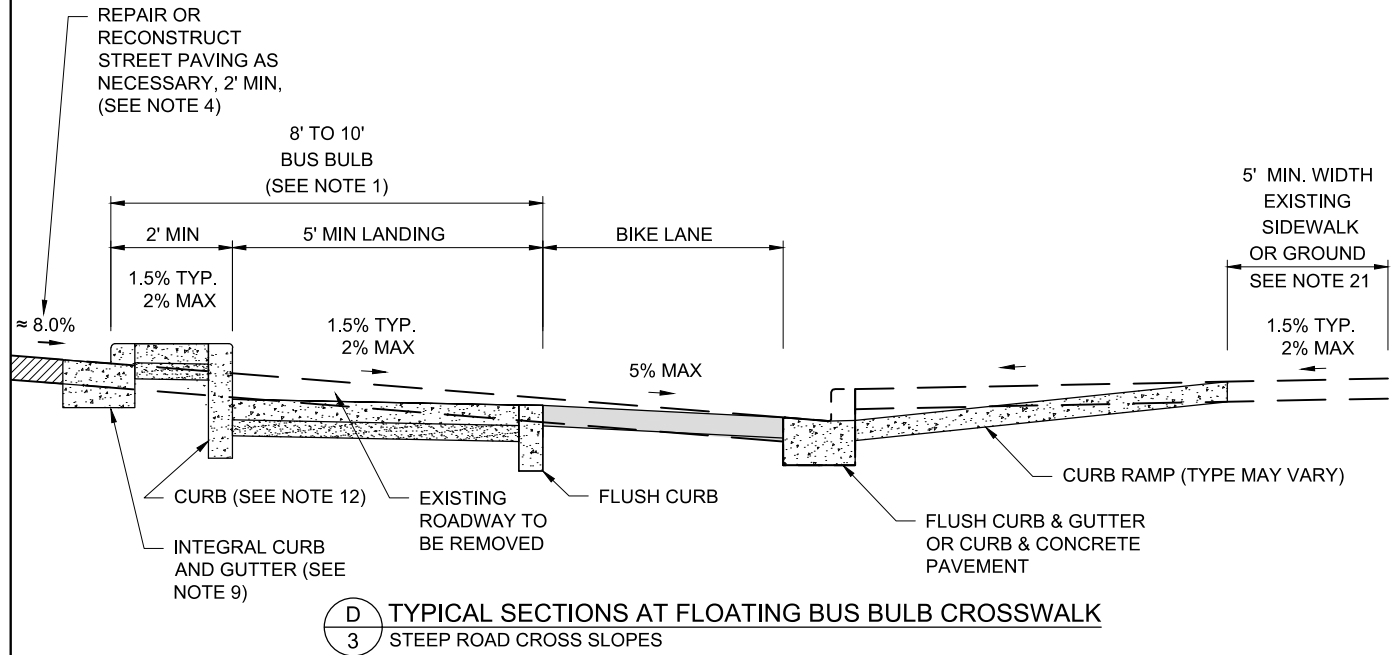

C:\Users\ccueva\OneDrive\Desktop\Cartosa\SSDI\Supplemental Design\Final\Bus Bulbs_BOE-040220.dwg
4/2/2020 7:42 PM

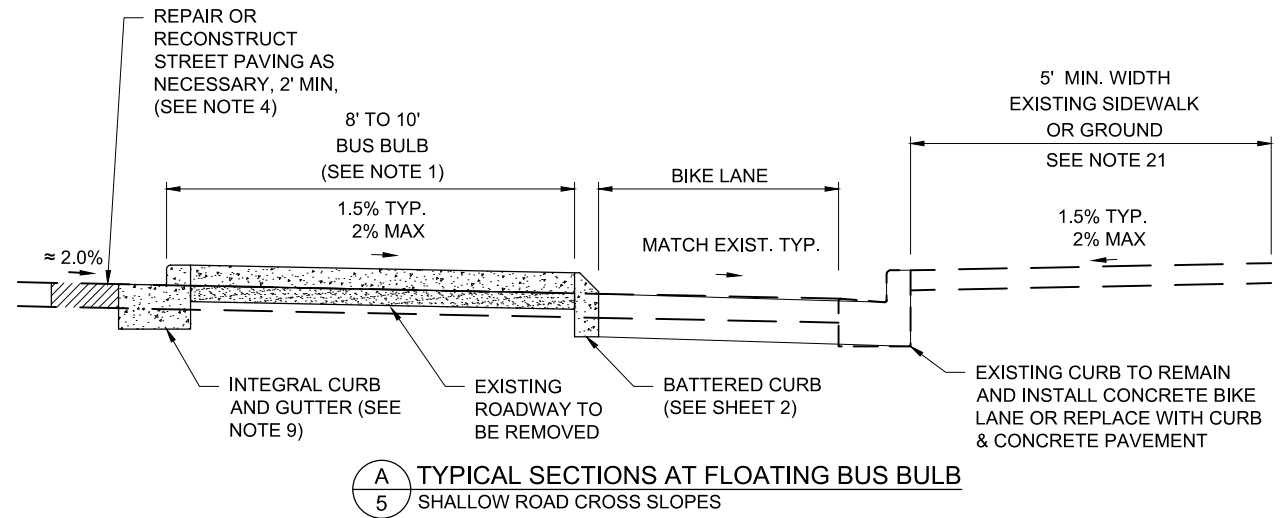
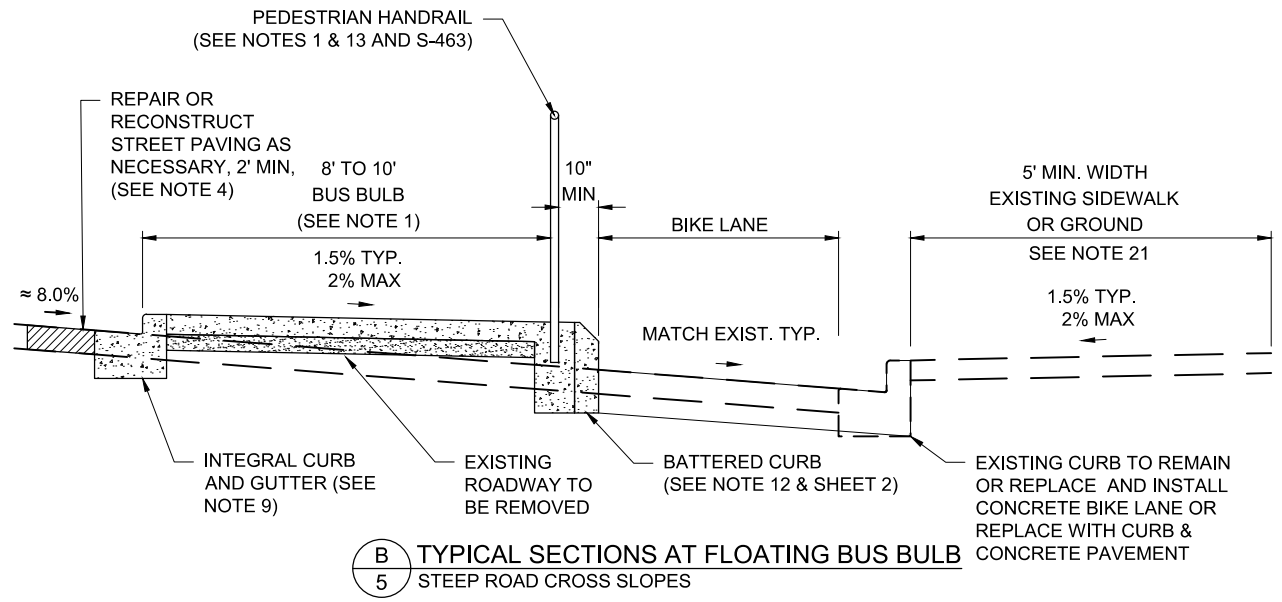
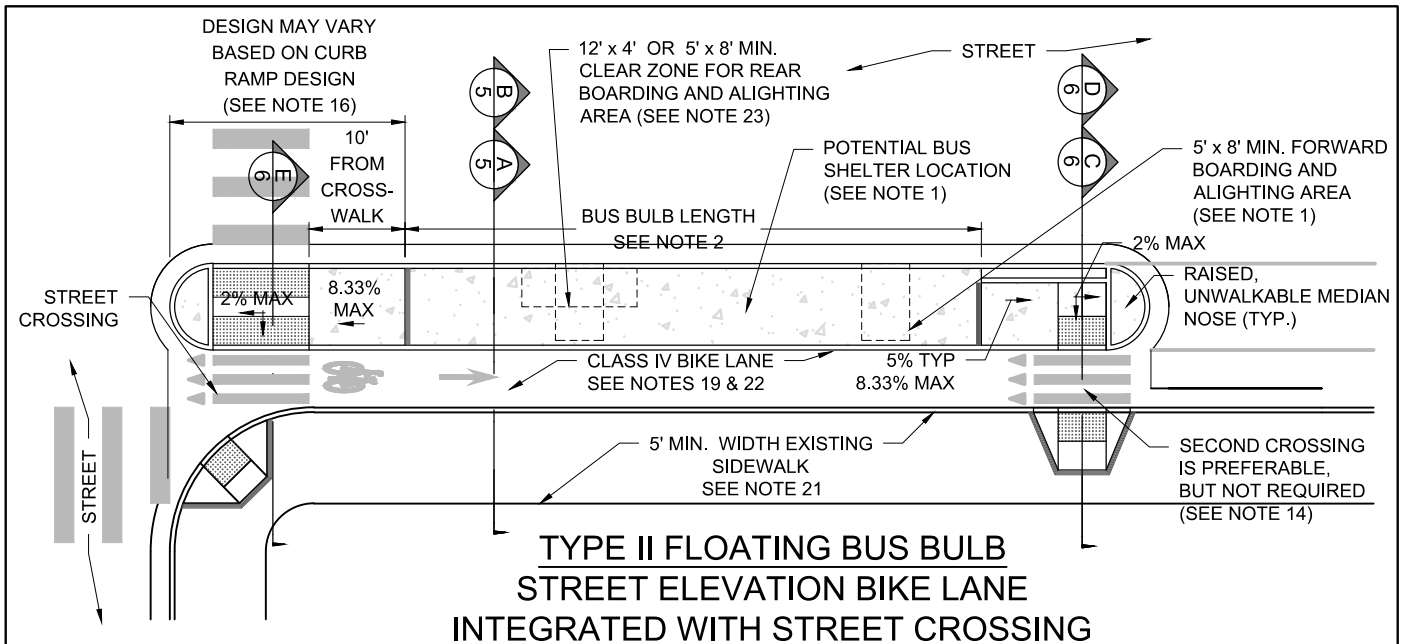

C:\Users\ccueva\Desktop\Cartosa\SSDI\Supplemental Design\Final\Bus Bulbs_BOE-040220.dwg
4/2/2020 8:56 PM

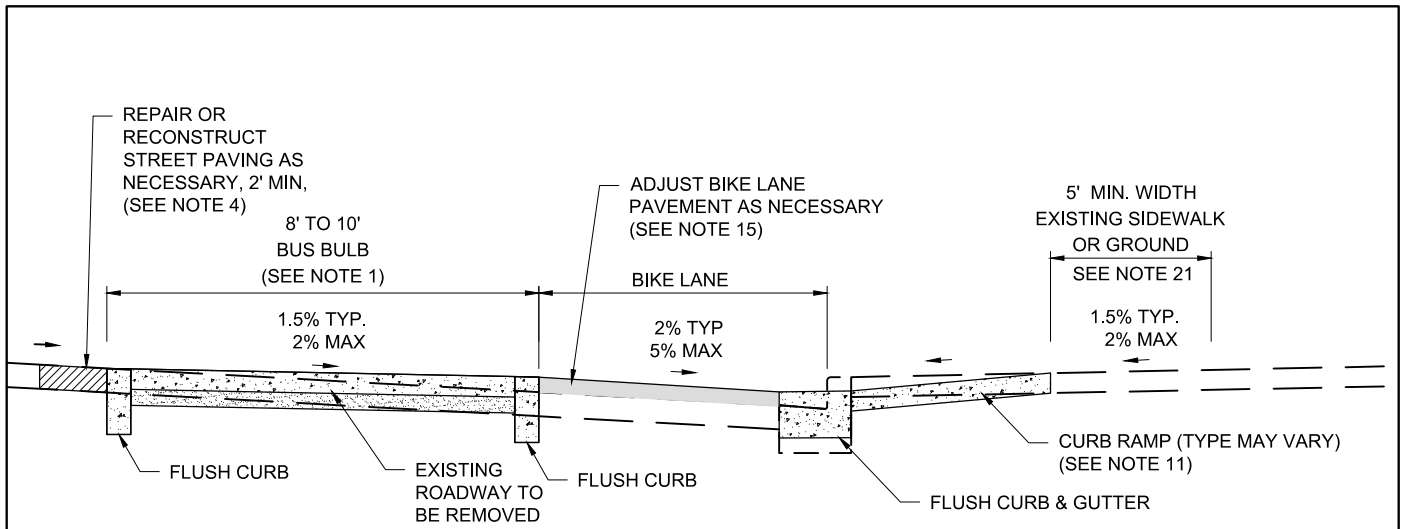

E TYPICAL SECTIONS AT FLOATING BUS BULB INTERSECTION CROSSWALK
5

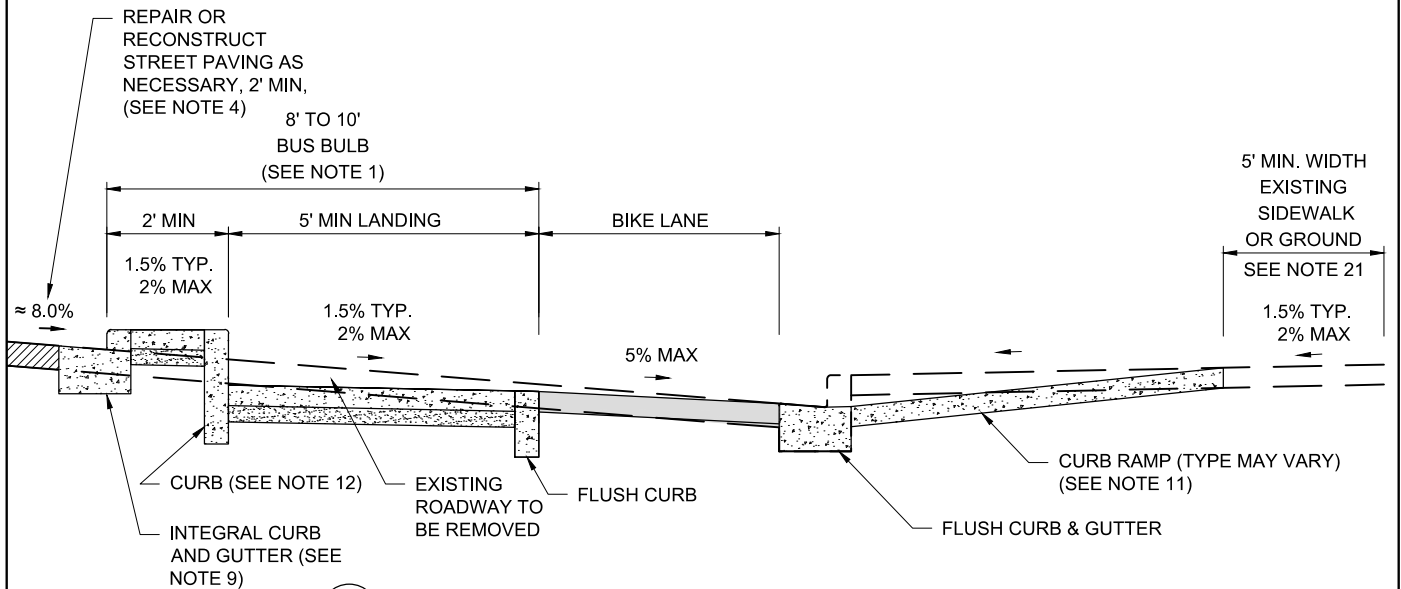

D TYPICAL SECTIONS AT FLOATING BUS BULB CROSSWALK
5 STEEP ROAD CROSS SLOPES

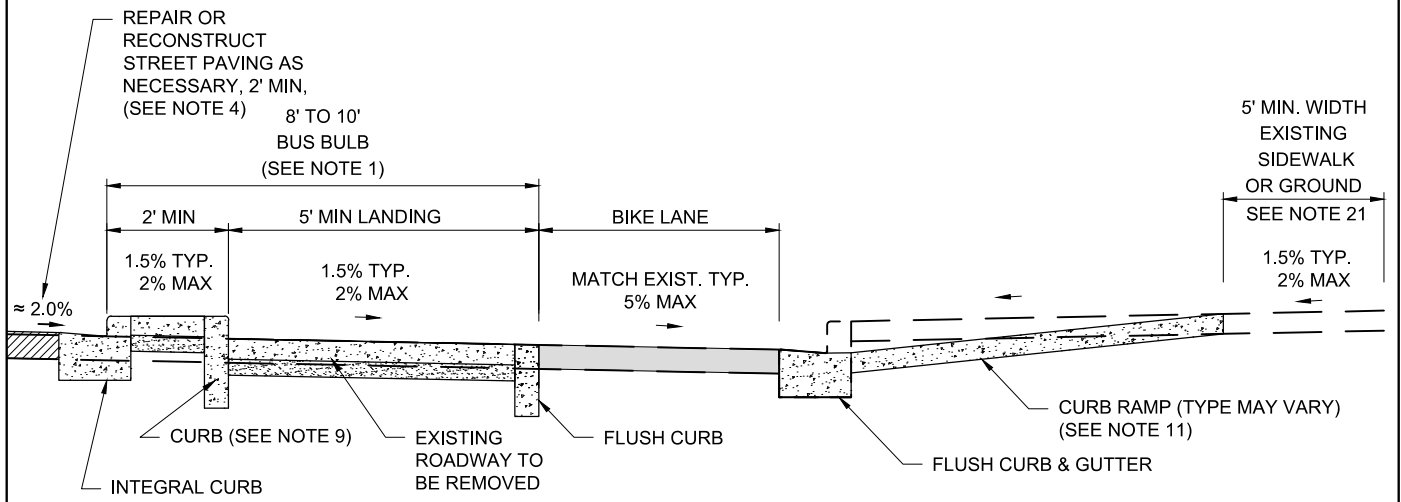

C TYPICAL SECTIONS AT FLOATING BUS BULB CROSSWALK
5 SHALLOW ROAD CROSS SLOPES

C:\Users\ccueva\OneDrive\Desktop\SSDI\Supplemental Design\Final\Bus Bulbs_BOE-040220.dwg
4/2/2020 7:50 PM

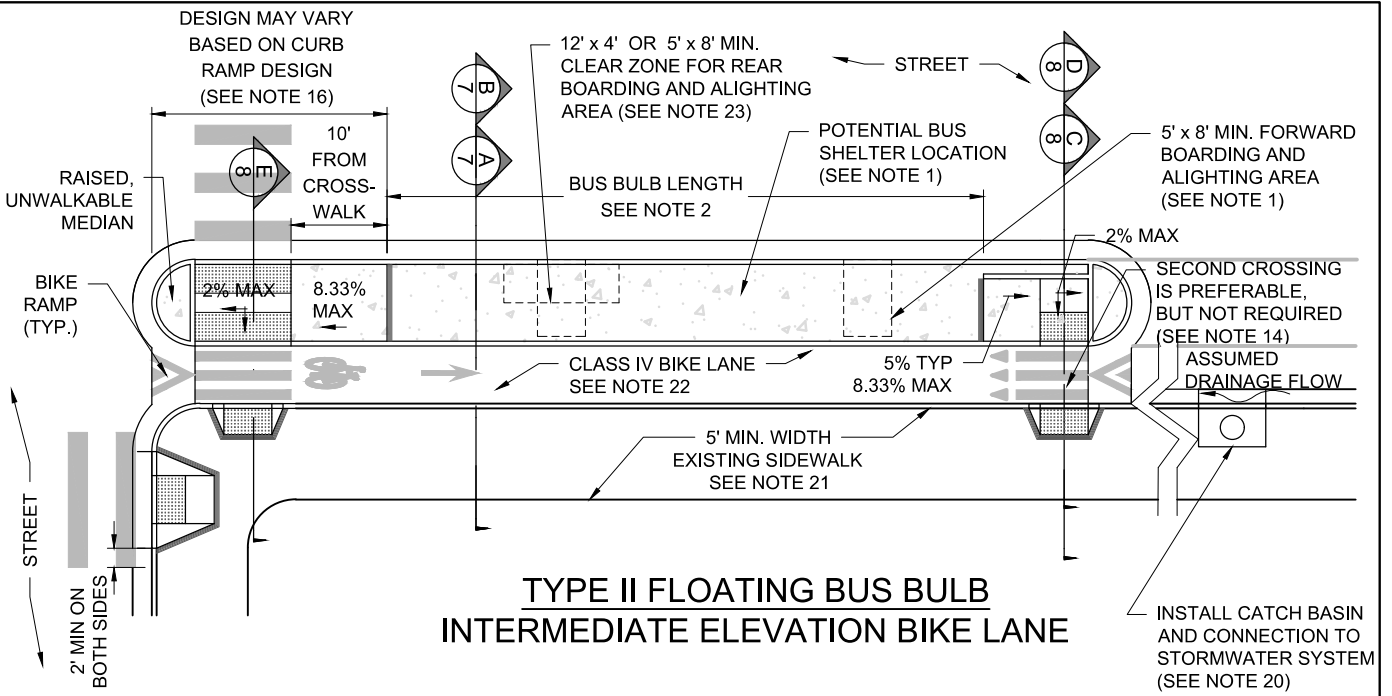

**TYPE II FLOATING BUS BULB
INTERMEDIATE ELEVATION BIKE LANE**

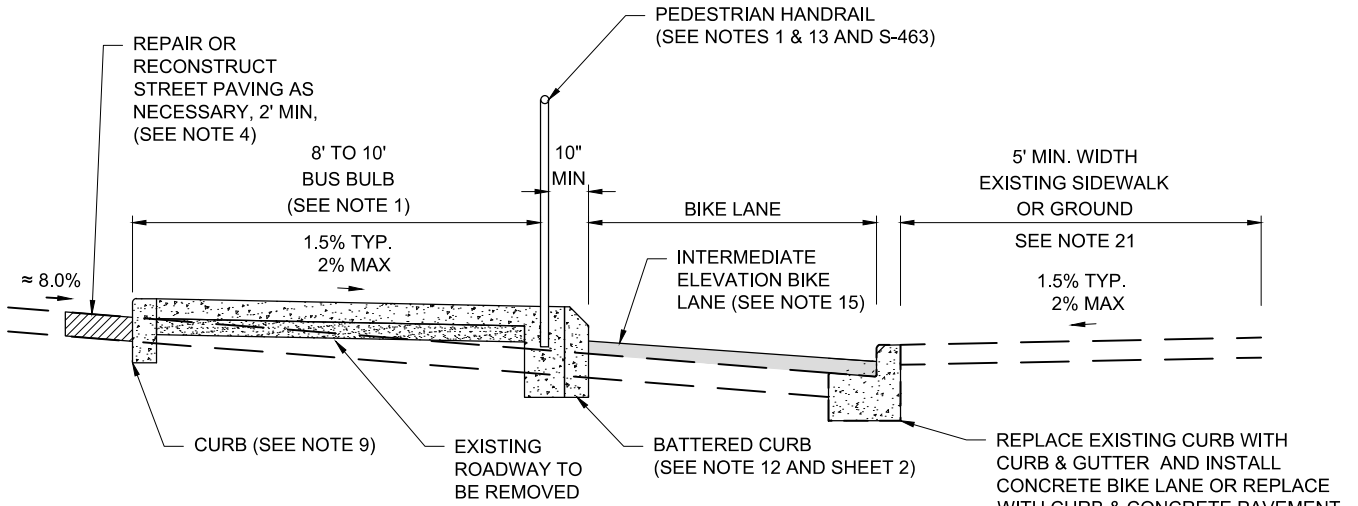

B TYPICAL SECTIONS AT FLOATING BUS BULB
7 STEEP ROAD CROSS SLOPES

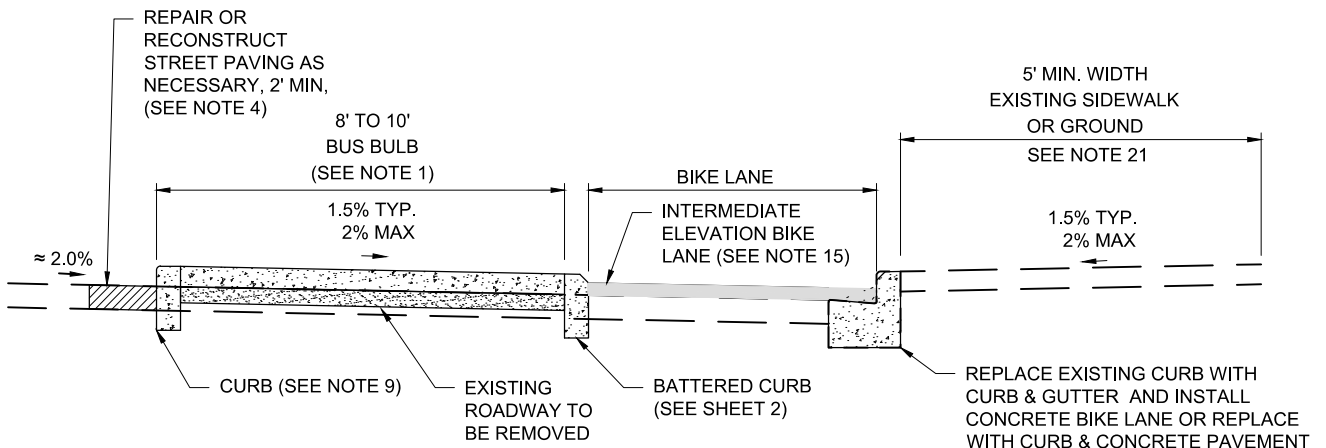

A TYPICAL SECTIONS AT FLOATING BUS BULB
7 SHALLOW ROAD CROSS SLOPES

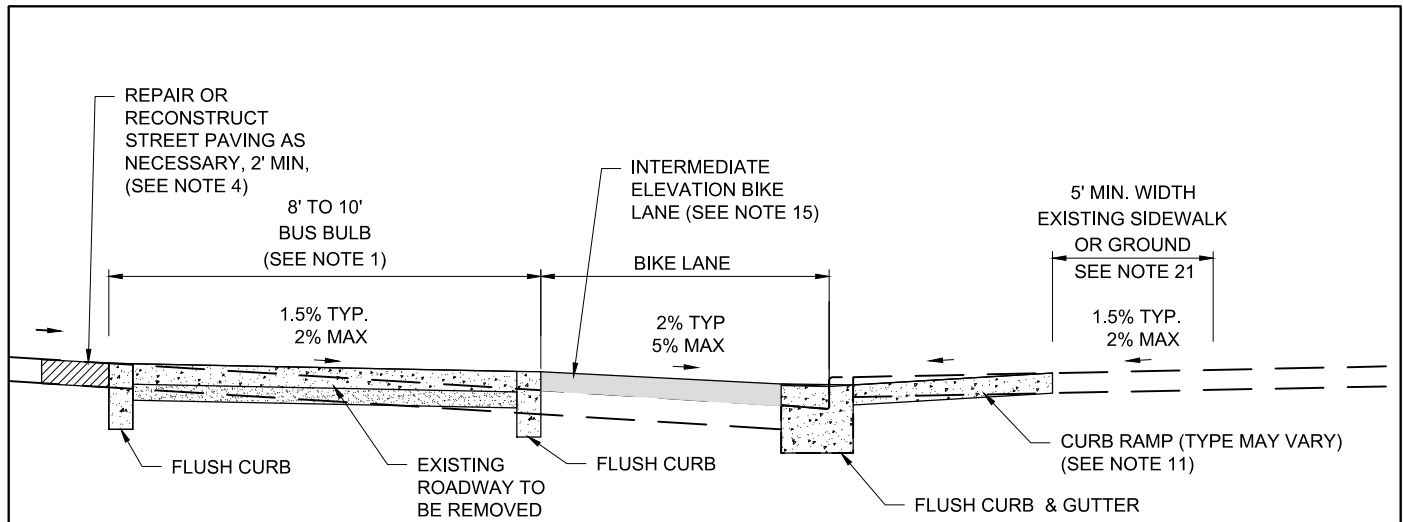

(E) TYPICAL SECTIONS AT FLOATING BUS BULB INTERSECTION CROSSWALK

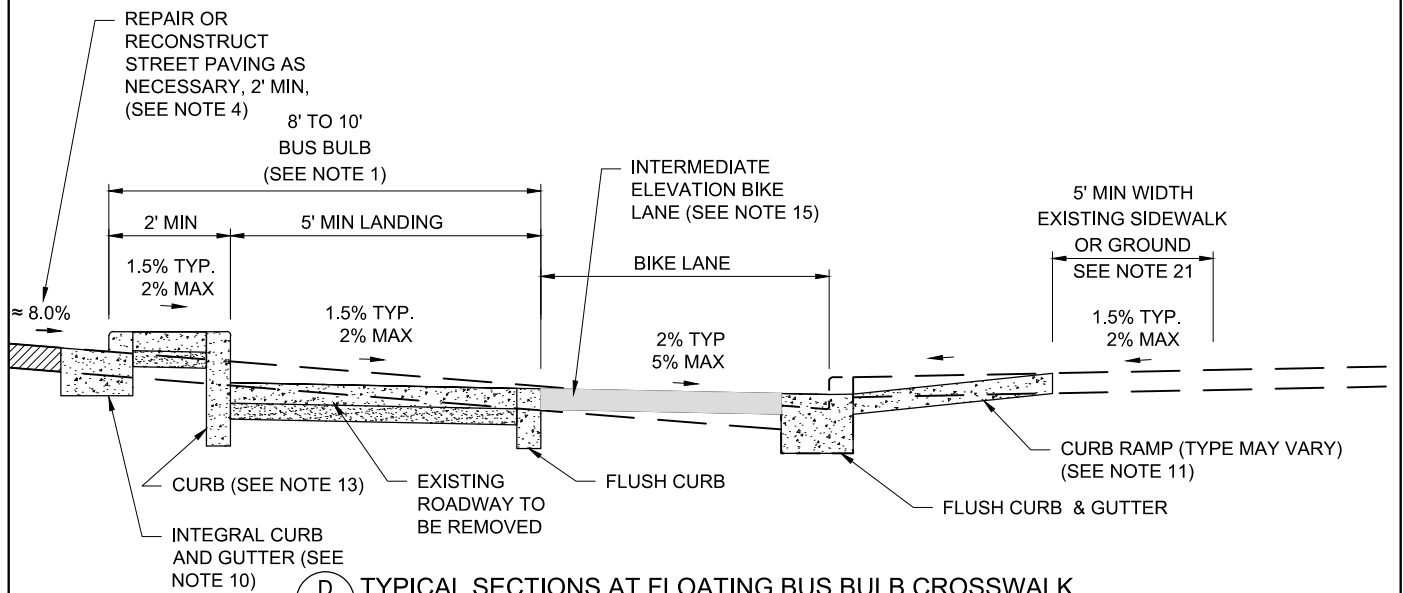

(D) TYPICAL SECTIONS AT FLOATING BUS BULB CROSSWALK
STEEP ROAD CROSS SLOPES

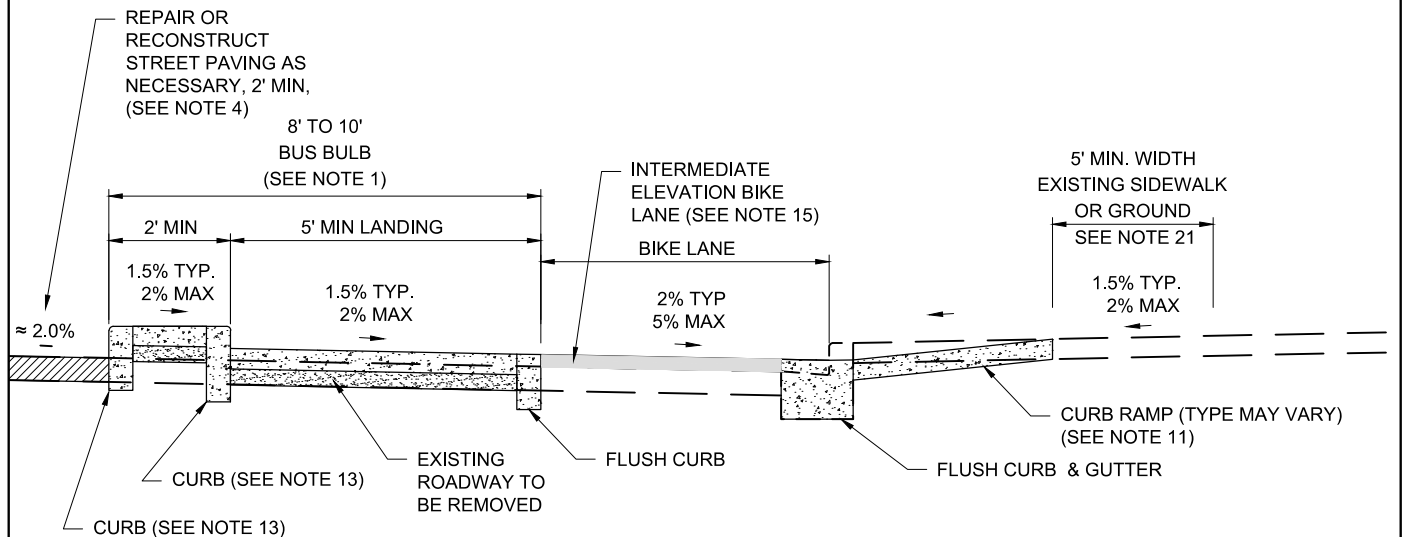

(C) TYPICAL SECTIONS AT FLOATING BUS BULB CROSSWALK
SHALLOW ROAD CROSS SLOPES

C:\Users\ccueva\Desktop\SSDI\Supplemental Design\Final\Bus Bulbs_BOE-040220.dwg
4/2/2020 2:10 PM

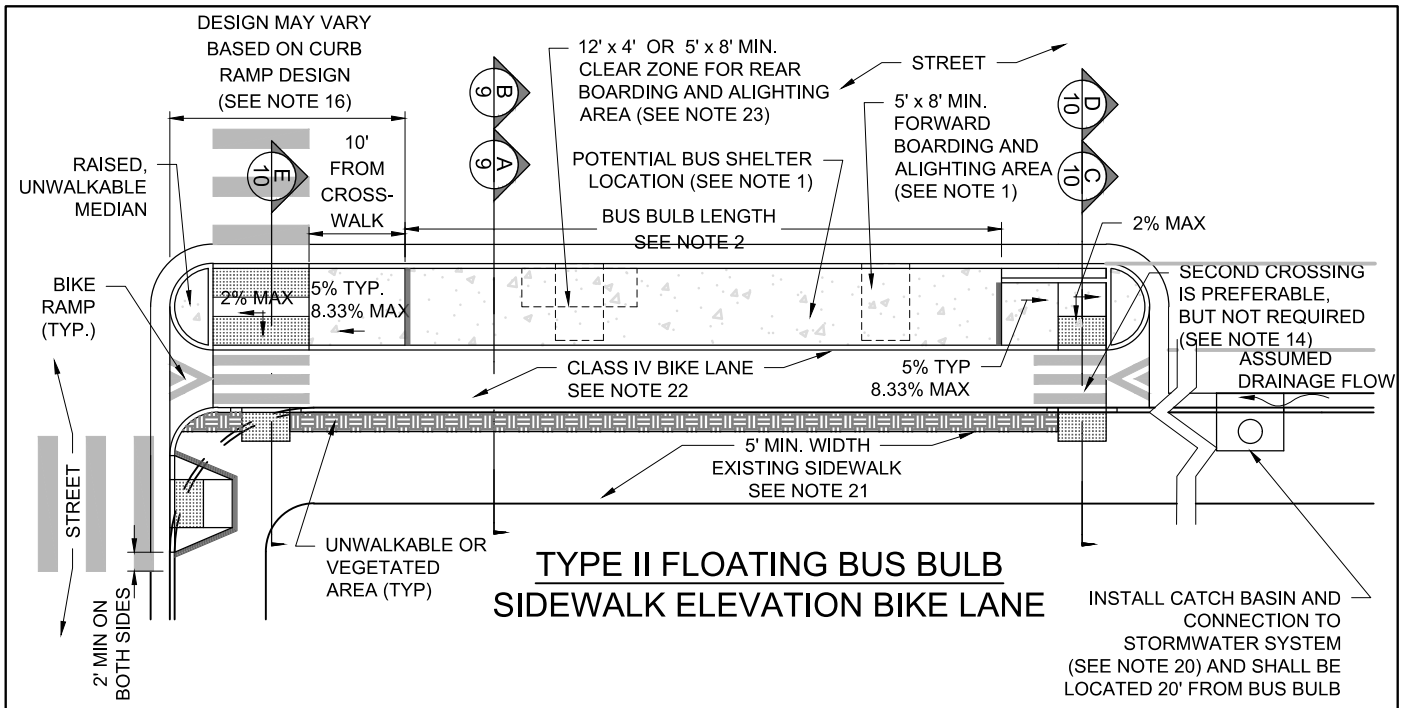

**TYPE II FLOATING BUS BULB
SIDEWALK ELEVATION BIKE LANE**

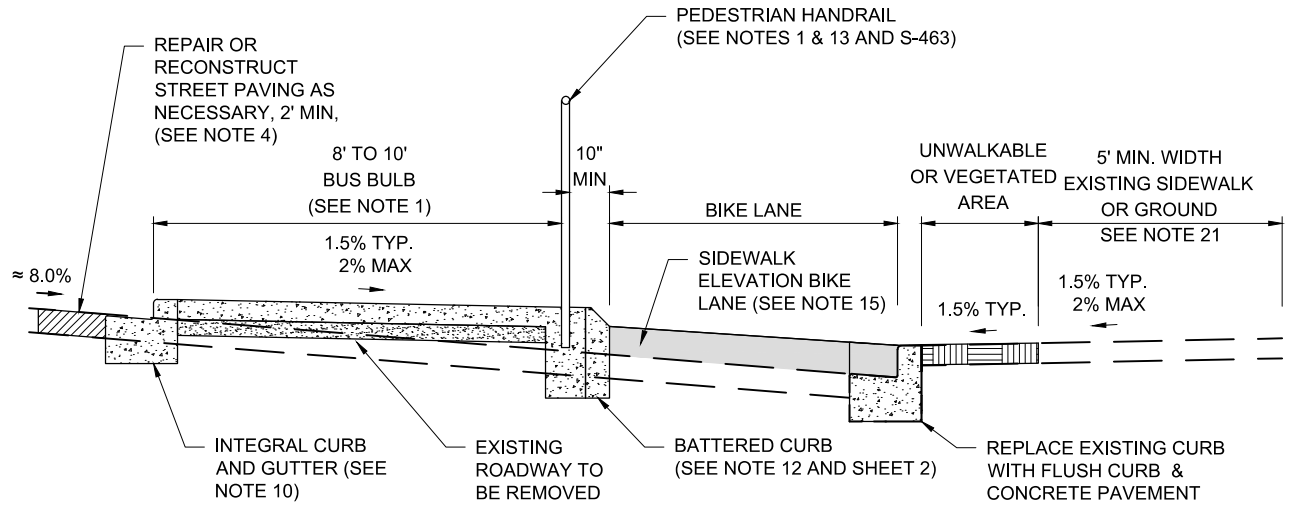

B TYPICAL SECTIONS AT FLOATING BUS BULB
9 STEEP ROAD CROSS SLOPES

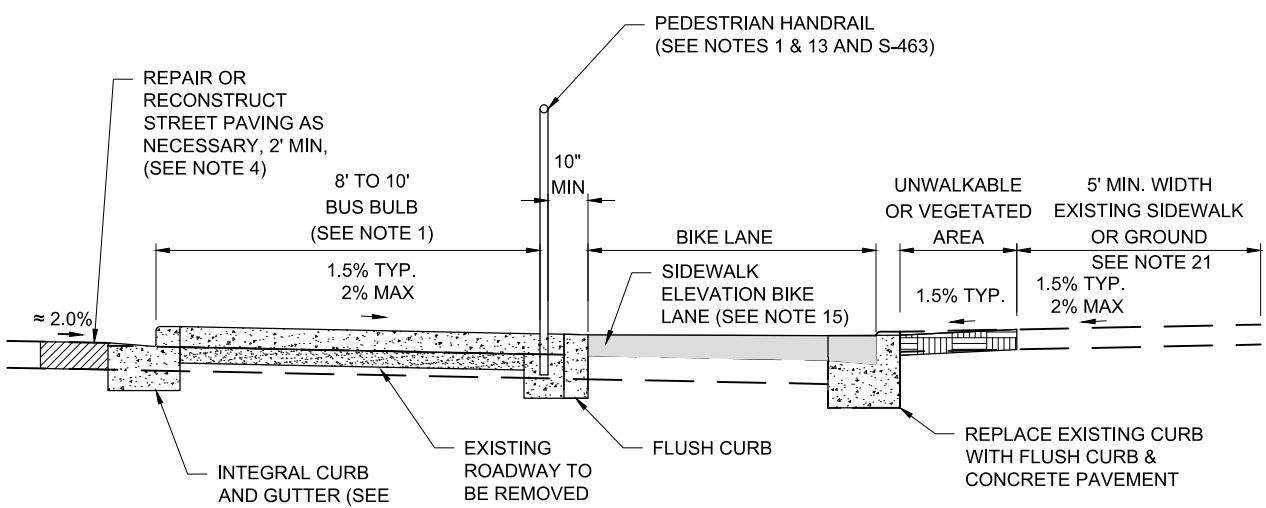

A TYPICAL SECTIONS AT FLOATING BUS BULB
9 SHALLOW ROAD CROSS SLOPES

C:\Users\ccueva\OneDrive\Desktop\SSDI\Supplemental Design\Final\Bus Bulbs_BOE-040220.dwg
4/2/2020 8:55 PM

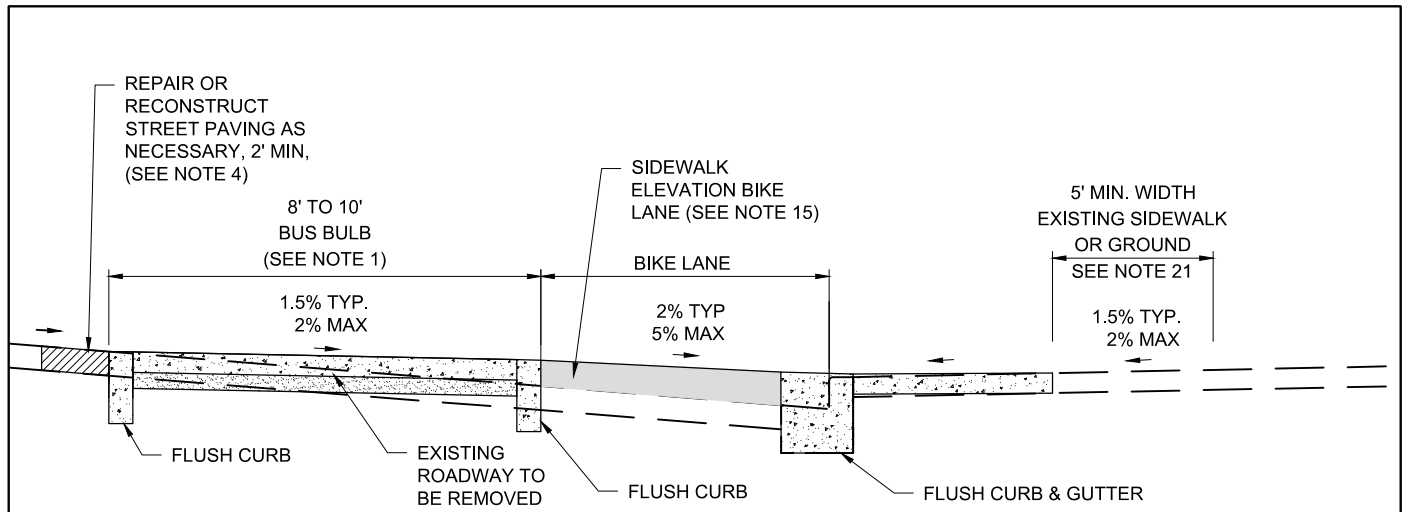

E TYPICAL SECTIONS AT FLOATING BUS BULB INTERSECTION CROSSWALK
9

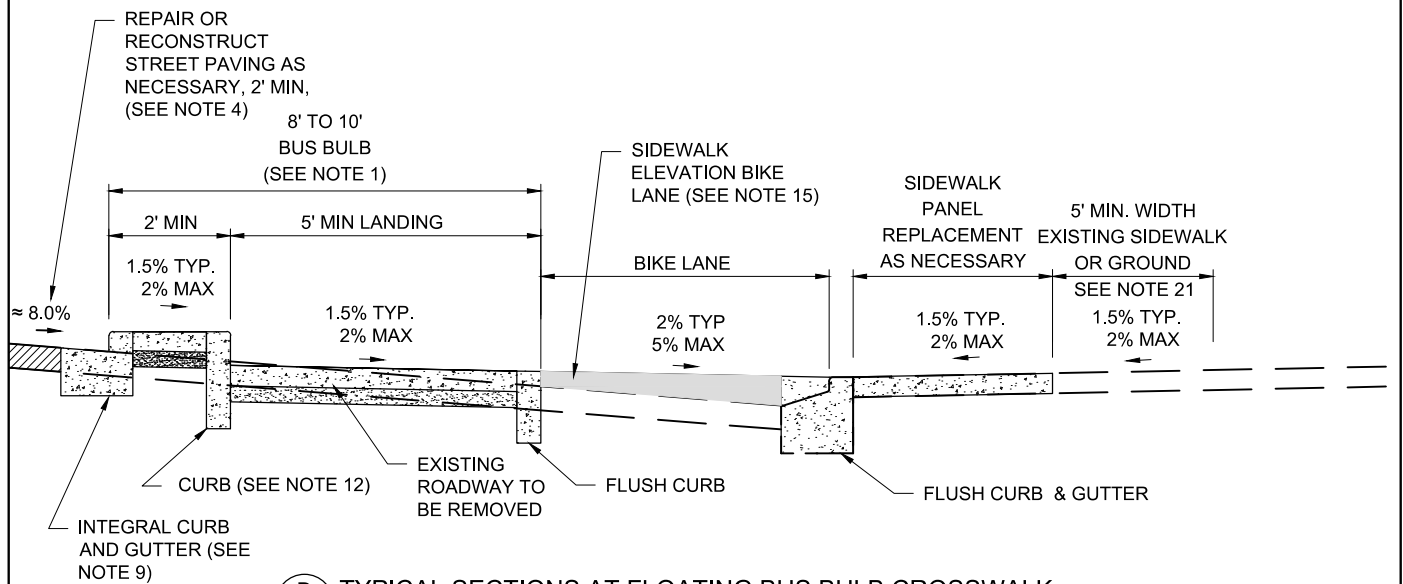

D TYPICAL SECTIONS AT FLOATING BUS BULB CROSSWALK
9 STEEP ROAD CROSS SLOPE

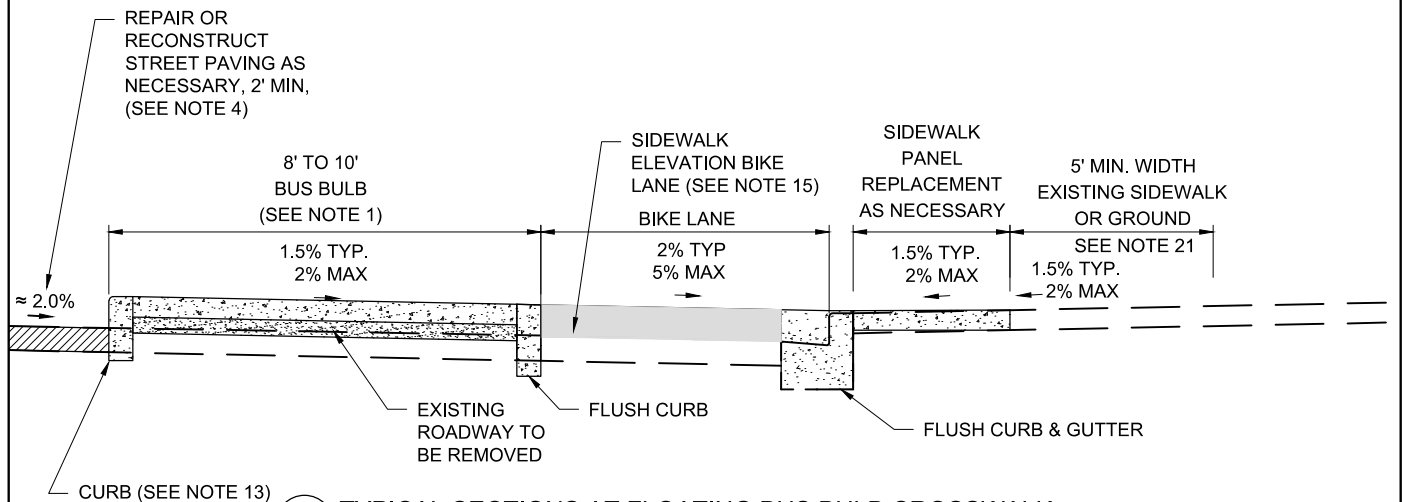

C TYPICAL SECTIONS AT FLOATING BUS BULB CROSSWALK
9 SHALLOW ROAD CROSS SLOPE

C:\Users\ccueva\OneDrive\Desktop\SSDI\Supplemental Design\Final\Bus Bulbs_BOE-040220.dwg
4/2/2020 2:10 PM

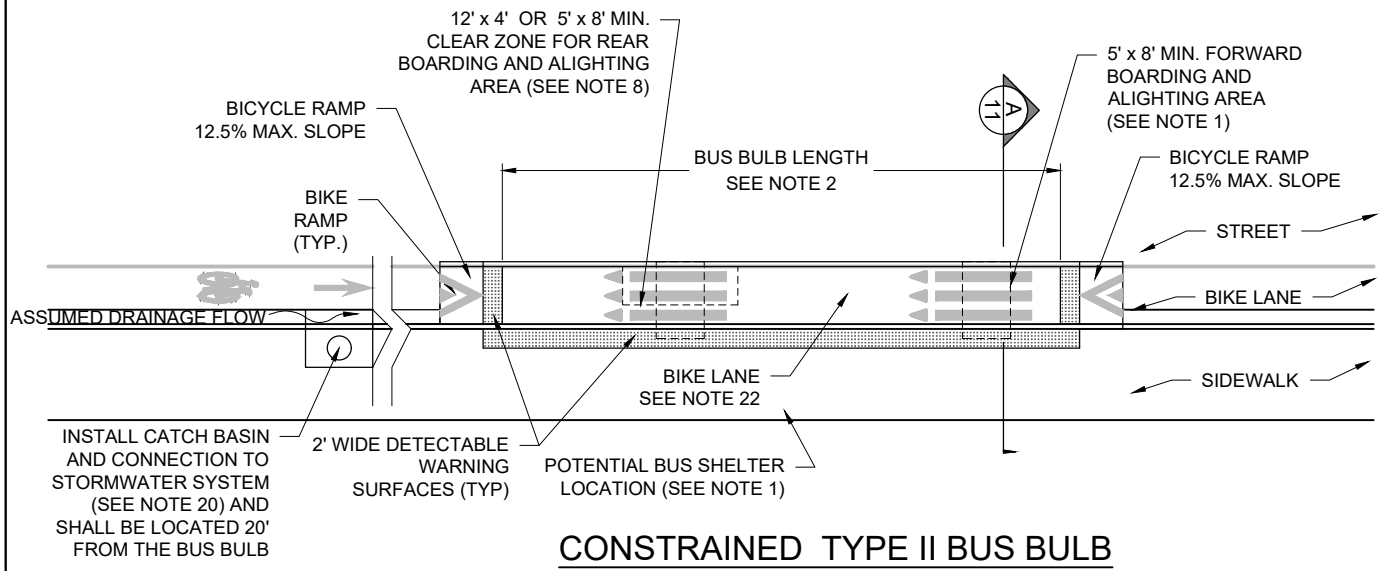

**CONSTRAINED TYPE II BUS BULB
RAISED BIKE LANE**

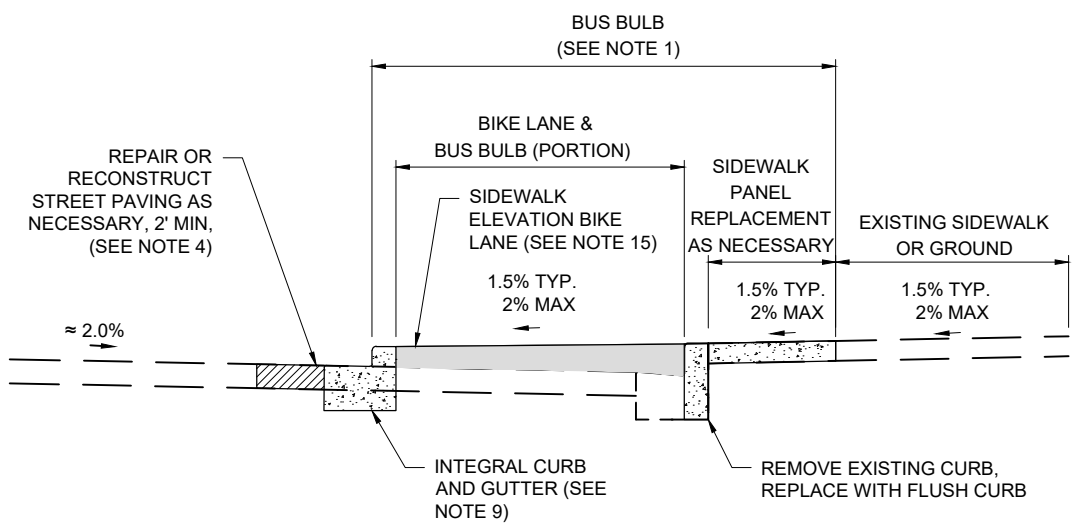

A
11 TYPICAL SECTIONS AT CONSTRAINED BUS BULB
SHALLOW ROAD CROSS SLOPES

Q:\SIG\Street Design Manual\200508 - Final\Bus Bulbs_BOE_DOT-200520.dwg
5/20/2020 8:18 AM

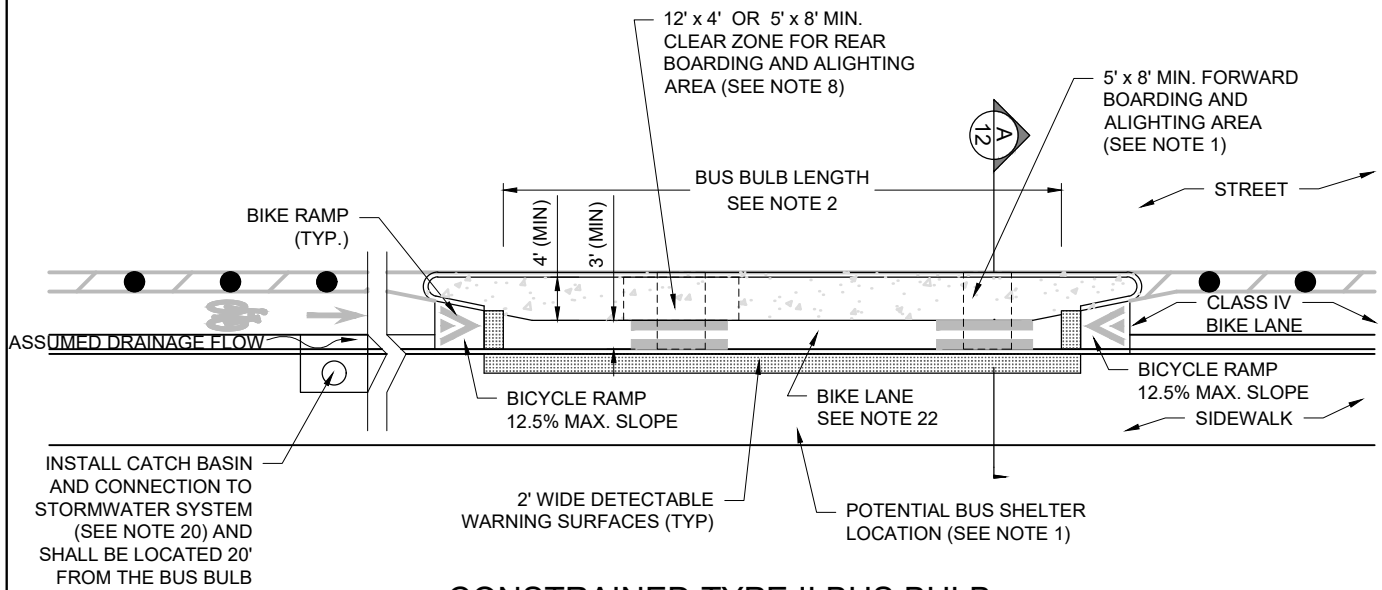

INSTALL CATCH BASIN AND CONNECTION TO STORMWATER SYSTEM (SEE NOTE 20) AND SHALL BE LOCATED 20' FROM THE BUS BULB

CONSTRAINED TYPE II BUS BULB RAISED BIKE LANE WITH NARROW BOARDING AND ALIGHTING AREA

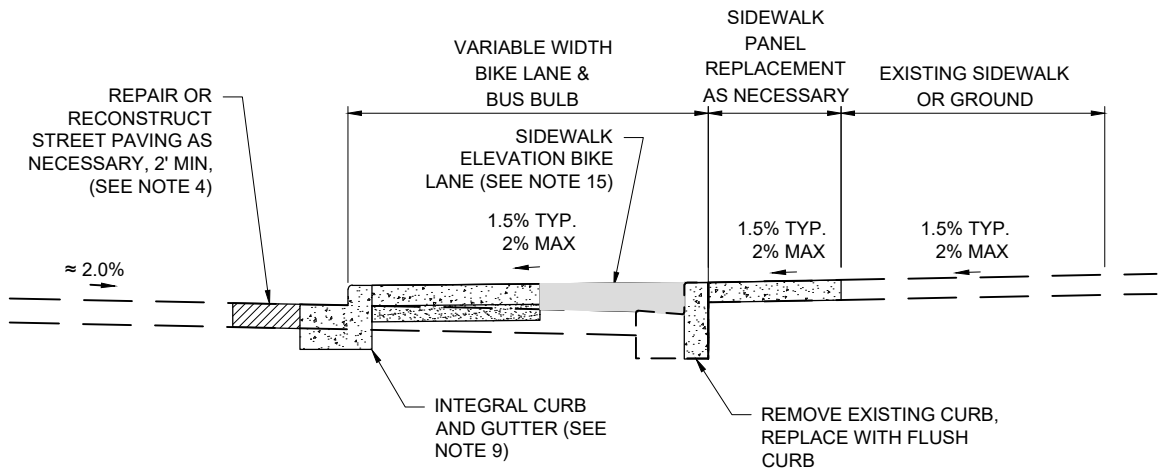

A
12 TYPICAL SECTIONS AT CONSTRAINED BUS BULB
SHALLOW ROAD CROSS SLOPES

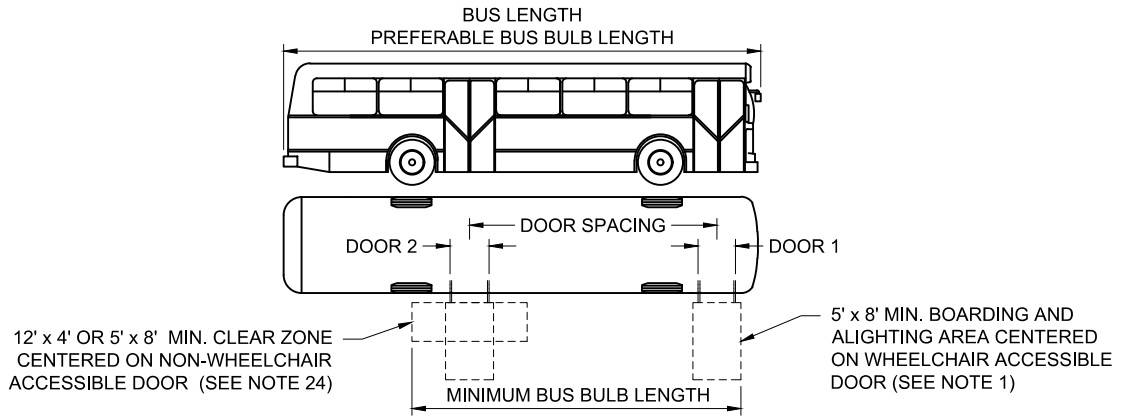

STANDARD BUS SHOWING DOORS, SPACING, AND BUS BULB LENGTHS
DOOR 1 (FRONT DOOR) DEPICTED AS WHEELCHAIR ACCESSIBLE DOOR

AGENCY	BUS SERIES	LENGTH (ft)	DOOR SPACING**		FRONT DOOR WIDTH		REAR DOOR WIDTH		ACCESSIBLE DOOR*	TOTAL LENGTH OF DOORS AND SPACE BETWEEN (ft)	MINIMUM BUS BULB LENGTH (ft)
			1-2 (in)	1-2 (ft)	(in)	(ft)	(in)	(ft)			
DASH LADOT	EZRIDER	32	148	12.33	36	3	36	3	REAR*	15.33	21
	EZRIDER II	32	156	13.00	36	3	36	3	FRONT	16.00	22
	AXESS	35	180	15.00	36	3	36	3	FRONT	18.00	24
	GILLIG	30	165	13.75	36	3	30	2.5	FRONT	16.50	23
	K9LR	32	156	13.00	36	3	36	3	FRONT	16.00	22
	K7M	30	146	12.17	44	3.67	47	3.92	REAR*	15.96	21
	PROTERRA	35	221	18.42	33	2.75	39	3.25	FRONT	21.42	27
METRO	1001-1005	40	237	19.75	30	2.5	30	2.5	FRONT	22.25	29
	3850-4199	40	249	20.75	30	2.5	30	2.5	FRONT	23.25	30
	4200-4205	42	195	16.25	36	3	36	3	FRONT	19.25	25
	5300-5522	40	257	21.42	30	2.5	30	2.5	FRONT	23.92	30
	5600-6149	40	249	20.75	30	2.5	30	2.5	FRONT	23.25	30
	7000-7949	40	207	17.25	30	2.5	30	2.5	FRONT	19.75	26
	7980	40	208	17.33	30	2.5	30	2.5	FRONT	19.83	26
	8000-8650	45	255	21.25	30	2.5	30	2.5	FRONT	23.75	30

* DRAWING DEPICTS ACCESSIBLE DOOR AT FRONT OF BUS. IF ACCESSIBLE DOOR IS AT REAR OF BUS, 5' x 8' BOARDING AND ALIGHTING AREA MUST BE LOCATED AT REAR DOOR AND 12' x 4' BOARDING ALIGHTING AREA WILL BE LOCATED AT FRONT DOOR. ENSURE THAT ACCESSIBLE AREAS ARE PROVIDED BASED ON ALL BUSES EXPECTED TO USE THE BUS STOP.
** DOOR SPACING MEASURED TO CENTER ON THE DOORS.

BUS BULB LENGTHS (STANDARD BUS)

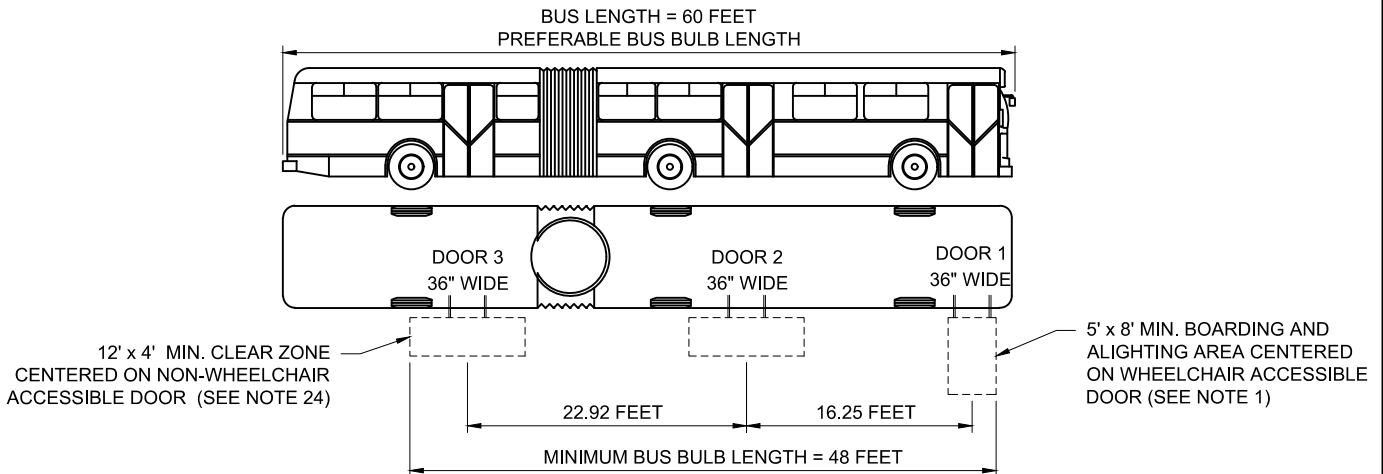

BUS BULB LENGTHS
(METRO 9200-9595 SERIES ARTICULATED BUS)

C:\Users\ccueva\Desktop\Cartosa\SSDI\Supplemental Design\Final\Bus Bulbs_BOE-040220.dwg
4/2/2020 2:11 PM

NOTES

1. A MINIMUM 5-FOOT WIDE BY 8-FOOT DEEP BOARDING AND ALIGHTING AREA, WITH A MAXIMUM SLOPE OF 2% IN ANY DIRECTION, IS REQUIRED AT FORWARD LOADING AREA ADJACENT TO THE BUS DOOR. THE 8-FOOT DEPTH MAY INCLUDE THE ADJACENT CURBLINE, BUT IS EXCLUSIVE OF ANY RAILING OR BATTERED CURB SPACE; AS SUCH THE PHYSICAL WIDTH OF THE BUS BULB MAY NEED TO EXCEED 8-FEET. A 4-FOOT MINIMUM CLEAR ACCESSIBLE ROUTE MUST BE PROVIDED BETWEEN THE BOARDING AND ALIGHTING AREA AND THE SIDEWALK. AN ACCESSIBLE ROUTE MUST ALSO BE PROVIDED BETWEEN ANY PROVIDED BUS SHELTERS AND THE BOARDING AND ALIGHTING AREA. IF A BUS BULB SERVES MULTIPLE TRANSIT VEHICLE STOPS SIMULTANEOUSLY, BOARDING AND ALIGHTING AREAS MUST BE PROVIDED AT EACH VEHICLE DOOR AND ACCESSIBLE ROUTES PROVIDED ACCORDINGLY.
2. THE MINIMUM BUS BULB LENGTH IS IDENTIFIED IN THE TABLE ON SHEET 13, BUT THE PREFERABLE LENGTH IS BASED ON THE LENGTH OF THE BUS(ES) EXPECTED TO USE THE BUS STOP. IF MULTIPLE BUSES ARE EXPECTED TO USE THE STOP AT THE SAME TIME, THE LENGTH SHOULD BE BASED ON THE BUS LENGTH(S) WITH 20-FEET OF SEPARATION BETWEEN THE BUSES. THE LENGTH OF A BUS BULB IS EXCLUSIVE OF ALL PEDESTRIAN RAMPS.
3. LENGTH OF SIDEWALK REPLACEMENT WILL VARY BASED THE WIDTH OF THE BUS BULB, EXISTING ROADWAY CROSS SLOPES, CURB REVEAL, AND THE SLOPE AND GRADE OF EXISTING SIDEWALKS.
4. MODIFICATIONS TO EXISTING STREET PAVING, COLD PLANE AND OVERLAY ASPHALT OR COMPLETELY RECONSTRUCT PAVING AS NECESSARY TO RESTORE A SMOOTH TRANSITION AND STREET CROWN (STANDARD PLAN S-433, SIMILAR), MATCH PAVING MATERIALS AND THICKNESS, SEE S-410 FOR STANDARD CURBS & GUTTERS, AND WARP NEW GUTTER TO JOIN INVERT AT INLET. CURB WITH GUTTER MAY BE USED ALONG THE STREET EDGE WHERE NECESSARY TO IMPROVE CONSTRUCTABILITY OR TO MANAGE STORMWATER FLOW.
5. CONSTRUCT CONCRETE SIDEWALK WHEN SPECIFIED ON PLAN. SIDEWALK MINIMUM CLEARANCE 48".
6. ALL CONCRETE & SIDEWALKS SHALL BE CLASS 520-C-2500 PORTLAND CEMENT CONCRETE. INSTALL CONTRACTION, EXPANSION AND WEAKENED PLANE JOINTS IN CONCRETE PER S-480 & S-430.
7. MINIMUM RELATIVE COMPACTION OF EARTHWORK UNDER NEW PAVING SHALL BE PER SSPWC. SEE S-480 FOR FURTHER REQUIREMENTS.
8. EXISTING CURB HEIGHT GENERALLY VARIES FROM 5 INCHES TO 8 INCHES.
9. IN AREAS WITH AN EXISTING 8 INCH CURB HEIGHT IN PLACE, A CURB HEIGHT LESS THAN 8 INCHES MAY BE USED TO OBTAIN TRAVERSABLE SLOPES AND DRAINAGE TOWARDS THE GUTTER. CURB HEIGHTS OF AT LEAST 6 INCHES ARE PREFERRED AND MAY REQUIRE PARTIAL OR FULL ROADWAY REGRADING. CURB HEIGHTS OF 4 INCHES OR LESS MAY BE USED TO ACHIEVE POSITIVE DRAINAGE WITHOUT ROADWAY REGRADING. THE USE OF CURB HEIGHTS BELOW 5" REQUIRES THE APPROVAL OF THE CITY ENGINEER.
10. SLOPE TO REMAIN TRAVERSABLE AND DRAIN TOWARDS THE GUTTER. SLOPES NOT TO EXCEED 2%.
11. SEE STANDARD PLAN S-442 FOR DETAILS INVOLVING CURB RAMPS.
12. OVERALL CURB HEIGHT WILL VARY BASED ON EXISTING GRADES, CURB REVEALS, AND OPPORTUNITIES TO ADJUST THE CURBLINE ELEVATION AT THE EDGE OF ROAD. ENSURE THAT THE CURB DEPTH EXTENDS AT LEAST 8 INCHES BELOW FINISHED GRADE. FOR CURB REVEAL HEIGHTS THAT EXCEED 9 INCHES, DESIGN CURB AS AN ISOLATED REINFORCED CONCRETE RETAINING CURB.
13. A HANDRAIL IS REQUIRED IF THE CURB REVEAL (DROP-OFF FROM THE BUS BULB TO THE ADJACENT BIKE LANE) EXCEEDS 8 INCHES. HOWEVER, A HANDRAIL MAY BE CONSIDERED FOR ANY CURB REVEAL OR ADJACENT TO SIDEWALK LEVEL BIKE LANES TO CHANNELIZE PEDESTRIANS TO THE CROSSWALKS.
14. PEDESTRIAN CROSSINGS FROM THE SIDEWALK TO BUS BULB MAY BE PROVIDED AT INTERSECTIONS, AT LOCATIONS SEPARATE FROM THE INTERSECTION, AND/OR AT THE ENDS FURTHEST FROM INTERSECTIONS. TWO PEDESTRIAN CROSSINGS ARE PREFERABLE BASED ON NATURAL PEDESTRIAN DESIRE LINES.
15. ADJUSTMENTS TO THE BIKE LANE ELEVATION MAY BE NECESSARY IF ROADWAY CROSS SLOPES EXCEED 2%. IF ADJUSTING GRADE, ENSURE THAT POSITIVE DRAINAGE IS MAINTAINED ALONG THE CURBLINE OR PROVIDE ADDITIONAL DRAINAGE STRUCTURES.
16. THE INTERSECTION CORNER RADIUS SHOULD BE ESTABLISHED FOLLOWING THE CORNER RADIUS POLICY IDENTIFIED IN THE SUPPLEMENTAL STREET DESIGN GUIDE.
17. VALLEYS CREATED FROM REVERSE SLOPES SHALL BE DRAINED BACK TO THE CURB WHEN POSSIBLE TO AVOID PONDING ON THE BUS BULB. TRENCH DRAINS WITH ADA COMPLIANT GRATES ARE ALSO APPROPRIATE. SEE CURB EXTENSION DETAIL FOR DESIGN GUIDANCE.
18. AS DEPICTED IN ALTERNATIVE A, SIDEWALK PANEL REPLACEMENT IS NOT REQUIRED TO BE CONTINUOUS ALONG A BUS BULB. 4' WIDE (MINIMUM) ACCESSIBLE ROUTES CAN BE CONSIDERED TO CONNECT THE SIDEWALK AND BUS BULB. IN THESE SCENARIOS, THE MAXIMUM SLOPE OF THIS CONNECTION MAY BE INCREASED FROM 2% TO 5%. ENSURE THAT THESE ACCESSIBLE ROUTES ARE LOCATED TO COINCIDE WITH BOARDING AND ALIGHTING AREAS AND PROVIDE ACCESS TO CURB RAMPS AND BUS SHELTERS AS APPLICABLE.
19. THE DESIGN DEPICTED IN PLAN VIEW SHOWS A STREET-ELEVATION CLASS IV BIKE LANE. BASED ON EXISTING ROADWAY CROSS SLOPES AND DESIRED BIKE LANE ELEVATION, AN INTERMEDIATE- OR SIDEWALK-ELEVATION CLASS IV BIKE LANE MAY BE PROVIDED. SHEETS 2 AND 7 THROUGH 12 DEPICT A VARIETY OF BIKE LANE ELEVATIONS WHICH CAN BE CONSIDERED.
20. WHERE POSITIVE DRAINAGE CANNOT BE ACHIEVED ALONG CURBLINES, INSTALL SIDE-OPENING CATCH BASIN PER STANDARD PLAN S-351 AND CONNECT TO EXISTING STORMWATER CONVEYANCE SYSTEM.
21. AT LOCATIONS WHERE THE SIDEWALK IS LESS THAN 5 FEET IN WIDTH, A CONSTRAINED BUS BULB SHOULD BE CONSIDERED.
22. THE BIKE LANE SURFACE SHOULD CONTRAST WITH THE ADJACENT SIDEWALK AND BUS BULB BY PROVIDING GREEN COLORED SURFACING APPROVED BY LADOT.
23. A MINIMUM 12-FOOT X 4-FOOT CLEAR SPACE, WITH A MAXIMUM SLOPE OF 2% IN ANY DIRECTION IS RECOMMENDED AT ALL REAR BUS DOORS. IF THE REAR DOOR SERVES AS THE WHEELCHAIR ACCESSIBLE LOADING DOOR, A 5-FOOT X 8-FOOT LOADING AREA IS REQUIRED.

C:\Users\ccueva\Desktop\Carloss\SSDI\Supplemental Design\Final\Bus Bulbs_BOE-040220.dwg
4/2/2020 2:11 PM

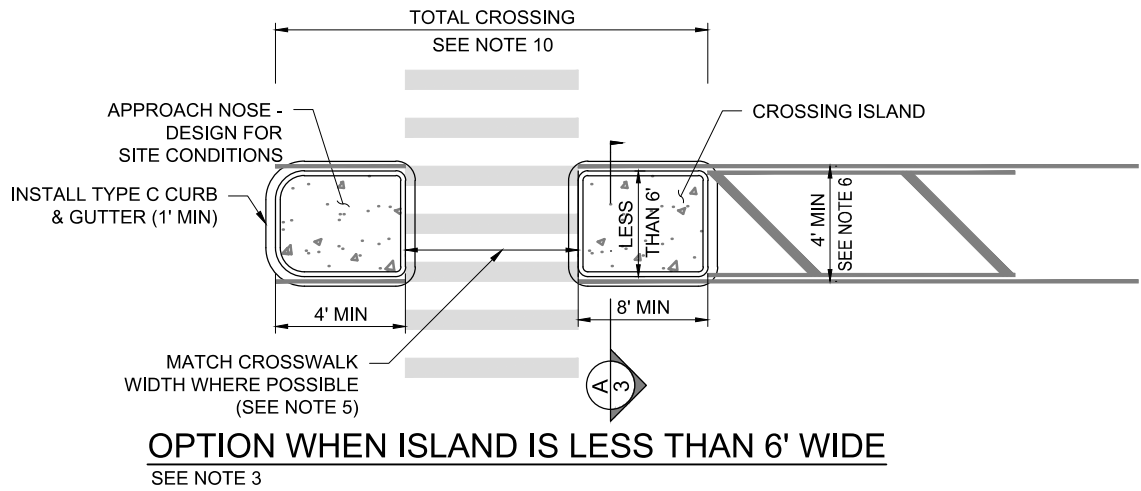
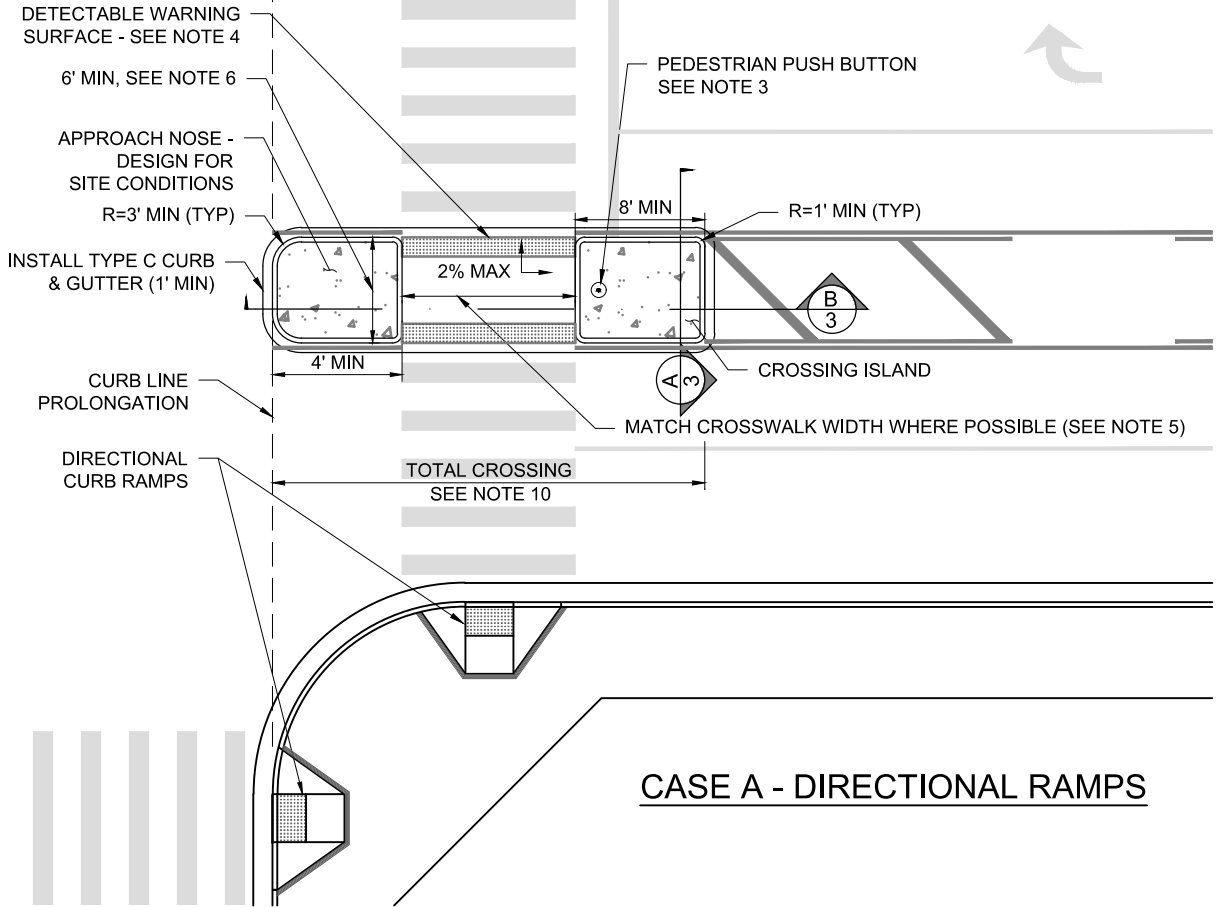

CROSSING ISLANDS

SUPPLEMENTAL
DESIGN GUIDE

DETAIL 500

SHEET 1 OF 3

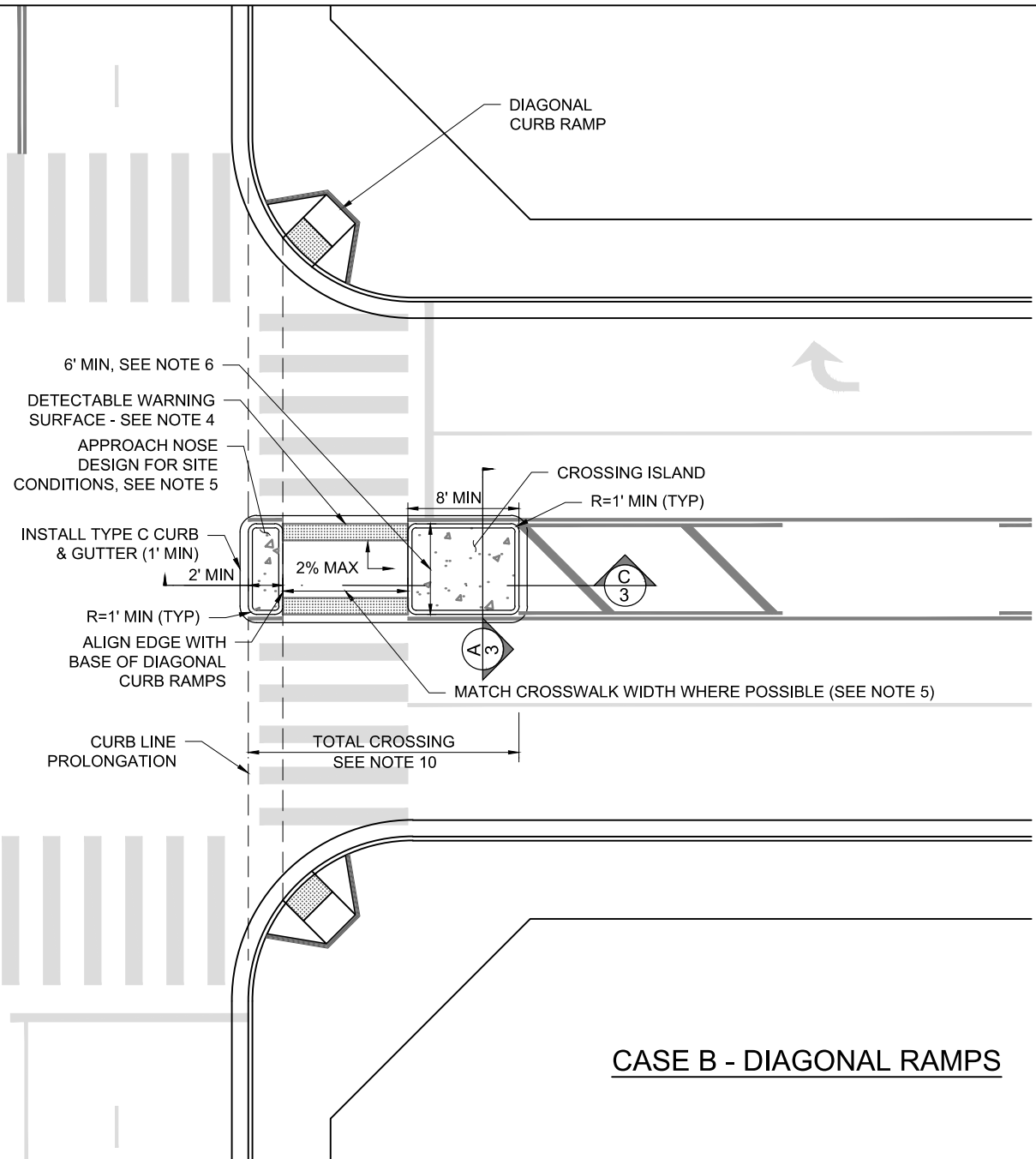

CASE B - DIAGONAL RAMPS

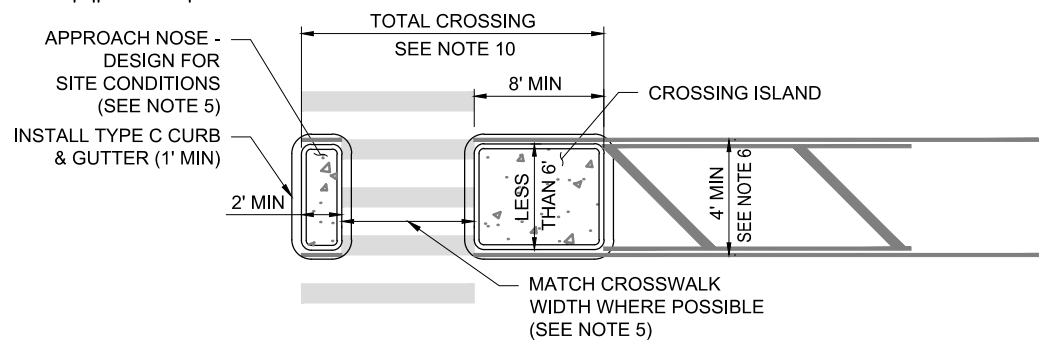

OPTION WHEN ISLAND IS LESS THAN 6' WIDE
SEE NOTE 3

C:\Users\306217\OneDrive - Office 365\SSD\Supplemental Design\02282020 - FINAL\2020-02-28 LADOT-BOE PLAN SET (1)\Crossing Island_BOE2.dwg
4/2/2020 5:01 PM

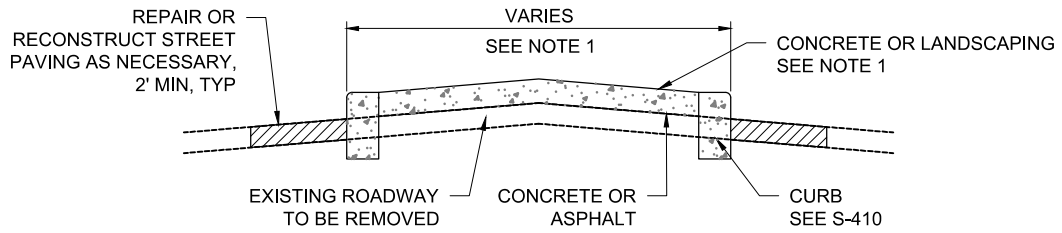

A CROSSING ISLAND SECTION
1-2 NO SCALE

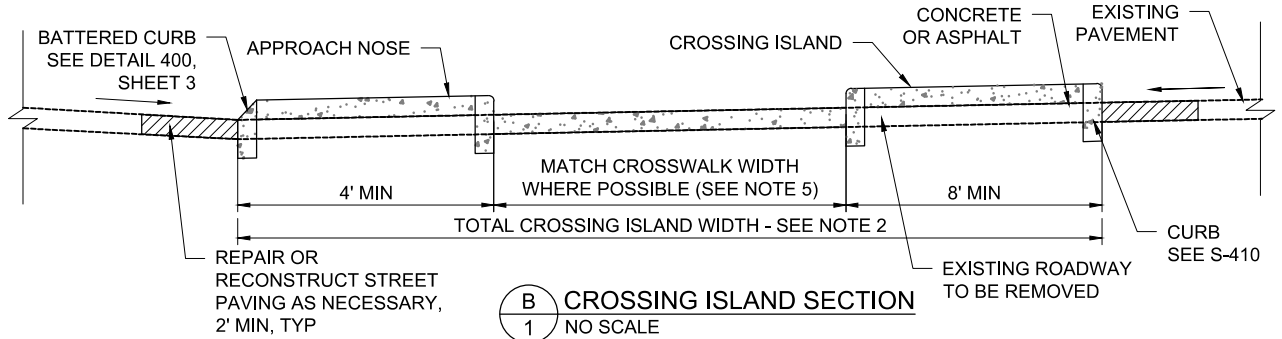

B CROSSING ISLAND SECTION
1 NO SCALE

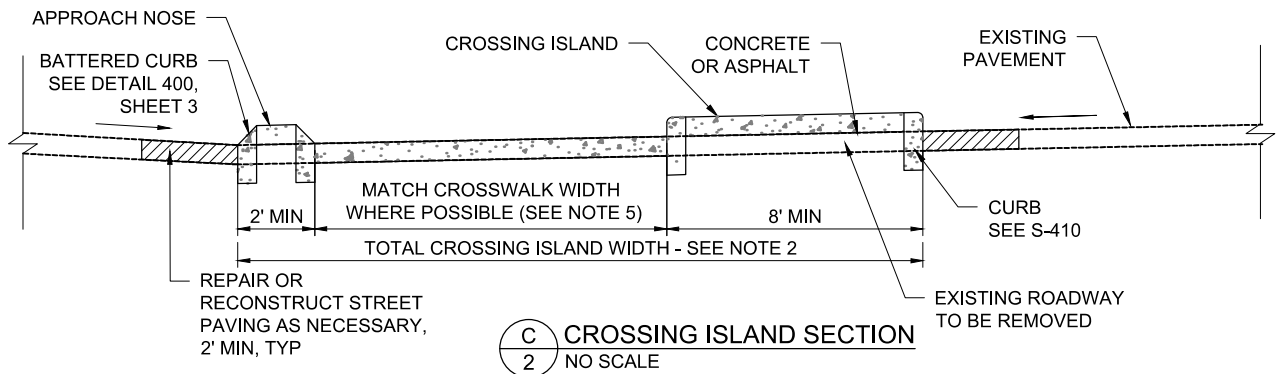

C CROSSING ISLAND SECTION
2 NO SCALE

NOTES

1. A MINIMUM OF 6 FOOT WIDTH IS REQUIRED TO PROVIDE PEDESTRIAN REFUGE. WIDTHS OF 8 TO 10 FEET ARE PREFERRED WHERE PEDESTRIAN VOLUMES ARE HIGH, WHERE PEOPLE WITH MOBILITY DEVICES CROSS, OR WHERE BICYCLISTS CROSS. THE MINIMUM WIDTH IS 4 FEET, BELOW WHICH A HARDENED CENTERLINE IS PREFERRED WHERE IT IS DESIRED TO SLOW LEFT-TURNING MOTORISTS.
2. THE TOTAL LENGTH OF THE CROSSING ISLANDS AND CROSSWALK SHALL BE LIMITED TO 30 FEET OR LESS ON STREETS WITH ONLY ONE THROUGH LANE IN EACH DIRECTION.
3. AT SIGNALIZED INTERSECTIONS, IF THE CROSSING ISLAND IS AT LEAST 6 FEET WIDE, THEN A PEDESTRIAN PUSH BUTTON MAY BE PROVIDED WITHIN THE CROSSING ISLAND WITH LADOT APPROVAL. PUSH BUTTONS SHOULD BE LOCATED AT THE CENTER OF THE ISLAND, BUT WIDER ISLANDS MAY NECESSITATE TWO PUSH BUTTONS CLOSER TO THE EDGE OF THE ISLAND. PUSH BUTTONS SHOULD BE LOCATED WITHIN 18 INCHES FROM CURB FACE. IF CROSSING ISLANDS ARE LESS THAN 6 FEET WIDE, THEN PEDESTRIAN CROSSING SIGNALS MUST BE TIMED TO ALLOW COMPLETE CROSSING AND NO PUSH BUTTONS SHALL BE LOCATED IN THE CROSSING ISLAND.
4. DETECTABLE WARNING SURFACES SHALL BE USED IF CROSSING ISLAND SERVES AS A PEDESTRIAN REFUGE. DETECTABLE WARNING SHALL BE 36" DEEP WHEN THE CROSSING ISLAND IS 8' OR MORE IN WIDTH. BETWEEN 6' AND 8', THE DETECTABLE WARNING SHALL BE 24" DEEP. THE DETECTABLE WARNING SHALL BE PLACED AT THE EDGES OF THE PEDESTRIAN ISLAND OR CUT-THROUGH MEDIAN, AND SHALL BE SEPARATED BY 24" MINIMUM OF WALKING SURFACE WITHOUT DETECTABLE WARNINGS.
5. IF THE PEDESTRIAN MEDIAN OPENING IS GREATER THAN 9 FEET WIDE, THEN A BOLLARD MAY BE CONSIDERED TO PREVENT VEHICLES FROM ENCRoACHING INTO THE PEDESTRIAN REFUGE SPACE. INSTALL BOLLARDS IN DETECTABLE WARNING SURFACE (DWS) AT 2' MAXIMUM, ALLOWING A MINIMUM OF 4' PATH IN BETWEEN BOLLARDS. FROM THE FLOW LINE NARROWING THE PEDESTRIAN MEDIAN OPENING TO LESS THAN THE CROSSWALK WIDTH MAY BE CONSIDERED IN ORDER TO CREATE SUFFICIENT SPACE FOR AN APPROACH NOSE.
6. WHEN DIAGONAL RAMPS ARE PRESENT, AN APPROACH NOSE MAY BE ADDED BY NARROWING THE CROSSING WIDTH (SEE NOTE 5). WHEN THIS IS NOT DESIRABLE, A RUBBERIZED MOUNTABLE APPROACH NOSE SHALL BE USED INSTEAD.
7. LANDSCAPING OF CROSSING ISLANDS SHALL FOLLOW SECTION E 467.3 OF THE BUREAU OF ENGINEERING STREET DESIGN MANUAL.
8. RAISED PAVEMENT MARKERS (RPM'S) ONE-WAY CLEAR (WHITE) OR ONE-WAY AMBER (YELLOW) SPACED 2' CENTER-TO-CENTER MAY BE INSTALLED ON THE CROSSING ISLAND DEPENDING ON ITS LOCATION. SEE LADOT STANDARD DRAWING S-525.0.

C:\Users\ccueva\Desktop\Cartosa\SSDI\Supplemental Design\Final\Crossing Island_BOE-040220.dwg
4/2/2020 9:05 PM

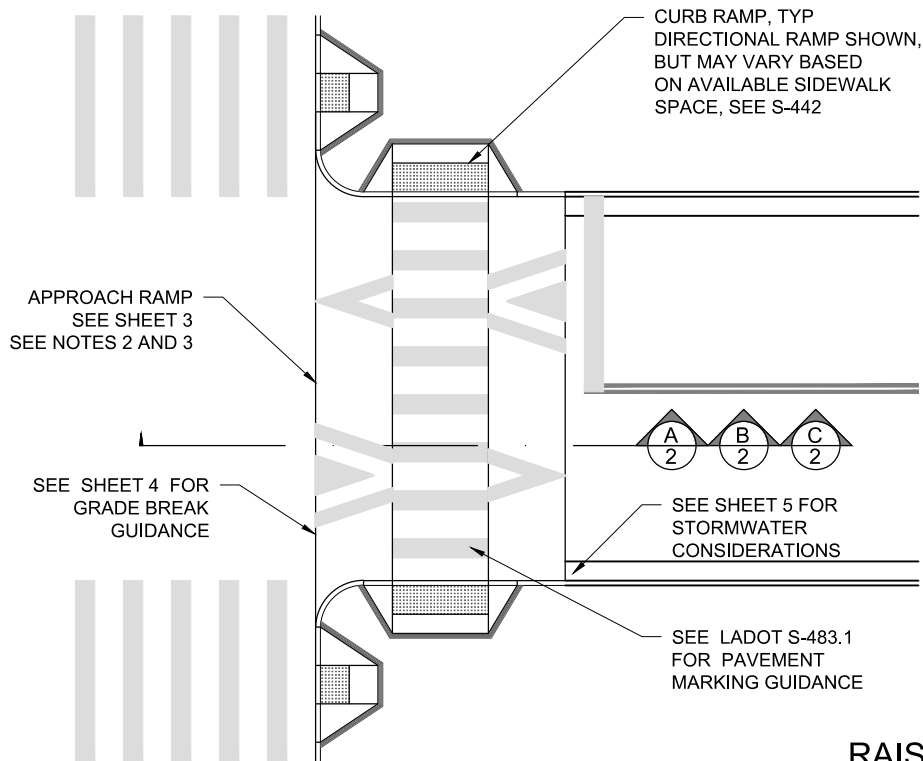

RAISED SIDE STREET

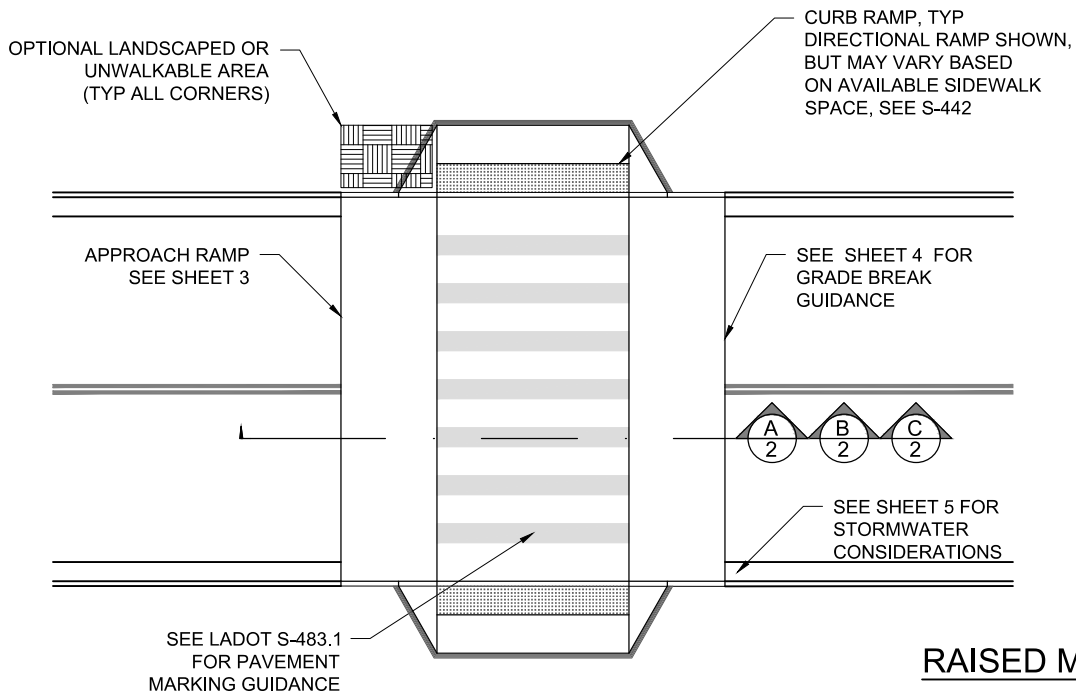

RAISED MID-BLOCK

RAISED CROSSINGS

SUPPLEMENTAL
DESIGN GUIDE

DETAIL 600

SHEET 1 OF 8

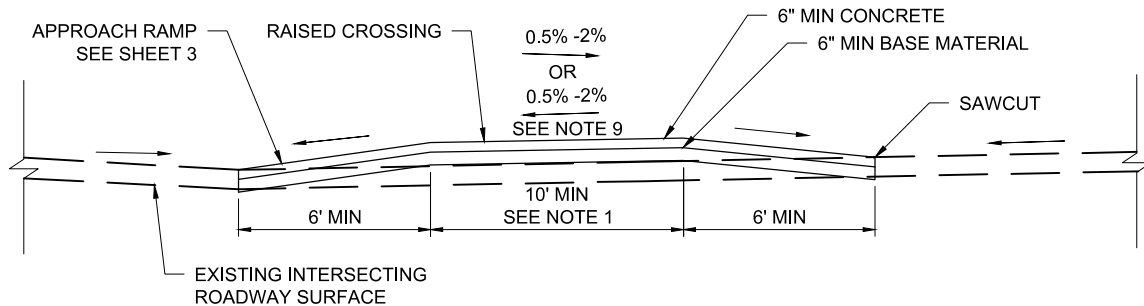

A CONCRETE RAISED CROSSING
1,7 N.T.S.

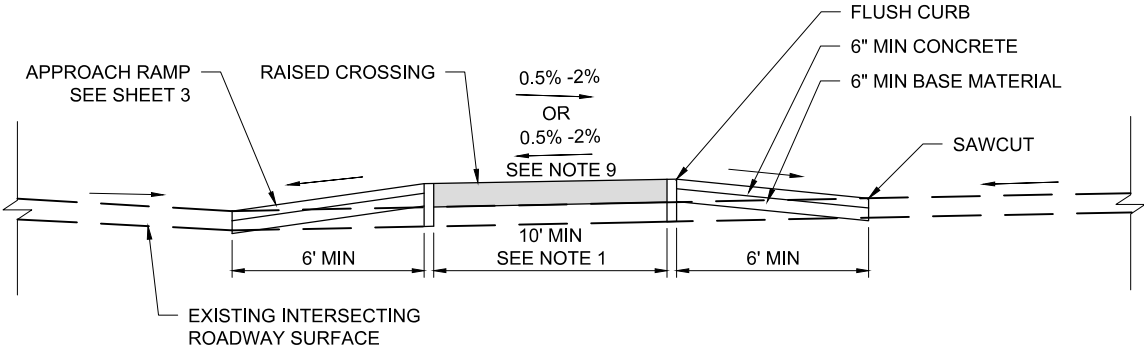

B CONCRETE RAMPS AND ASPHALT CROSSWALK
1,7 N.T.S.

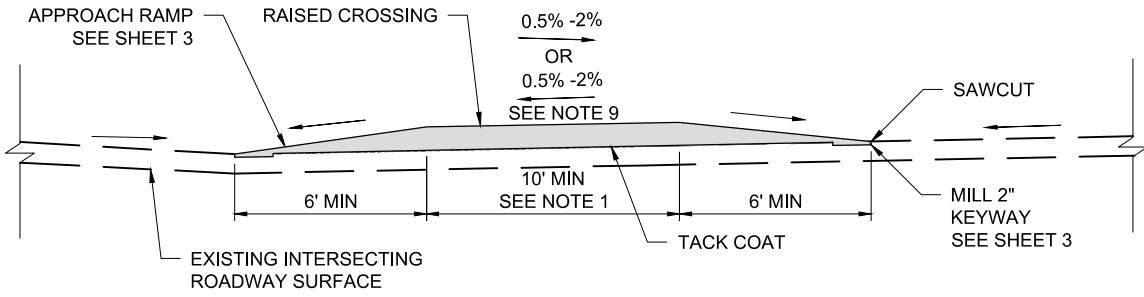

C ASPHALT RAISED CROSSING
1,7 N.T.S.

RAISED CROSSING SECTIONS

C:\Users\ccueva\Desktop\Carloss\SSDI\Supplemental Design\Final\Raised Crossings_BOE-040220.dwg
4/2/2020 9:14 PM

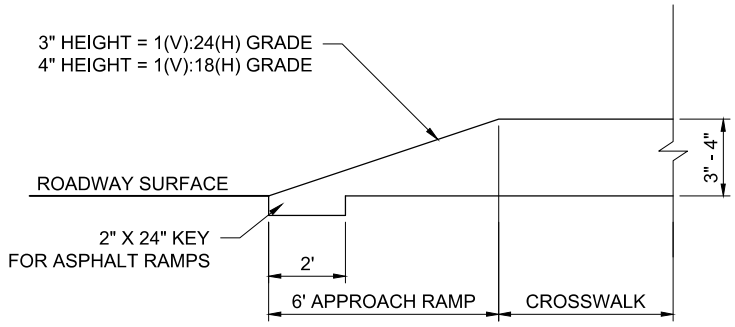

STRAIGHT APPROACH RAMP

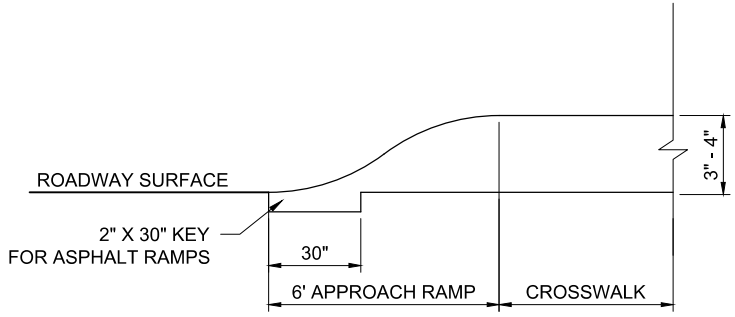

SINUSOIDAL APPROACH RAMP

3" HEIGHT - PARABOLIC APPROACH RAMP

DISTANCE (FEET)	0	0.5	1.0	1.5	2.0	2.5	3.0	3.5	4.0	4.5	5.0	5.5	6.0
FINISHED HEIGHT (INCHES)	0	0.05	0.20	0.44	0.75	1.11	1.50	1.89	2.25	2.56	2.80	2.95	3.00

4" HEIGHT - PARABOLIC APPROACH RAMP

DISTANCE (FEET)	0	0.5	1.0	1.5	2.0	2.5	3.0	3.5	4.0	4.5	5.0	5.5	6.0
FINISHED HEIGHT (INCHES)	0	0.07	0.27	0.59	1.00	1.48	2.00	2.52	3.00	3.41	3.73	3.93	4.00

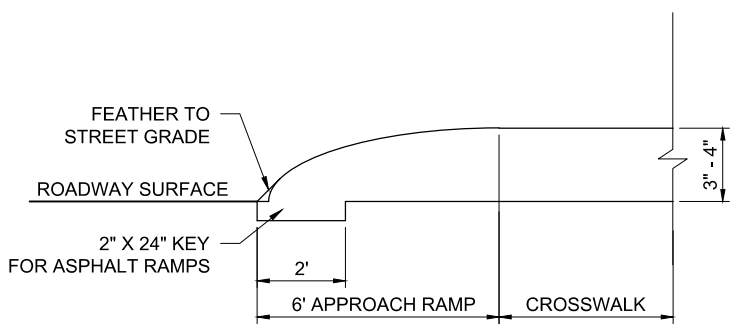

PARABOLIC APPROACH RAMP

3" HEIGHT - SINUSOIDAL APPROACH RAMP

DISTANCE (FEET)	0	1.0	2.0	3.0	4.0	5.0	6.0
FINISHED HEIGHT (INCHES)	0	1.2	1.7	2.1	2.4	2.7	3.0

4" HEIGHT - SINUSOIDAL APPROACH RAMP

DISTANCE (FEET)	0	1.0	2.0	3.0	4.0	5.0	6.0
FINISHED HEIGHT (INCHES)	0	1.6	2.3	2.8	3.3	3.7	4.0

APPROACH RAMP PROFILES

C:\Users\ccueva\OneDrive\Desktop\Cartosa\SSDI\Supplemental Design\Final\Raised Crossings_BOE-040220.dwg
4/2/2020 9:14 PM

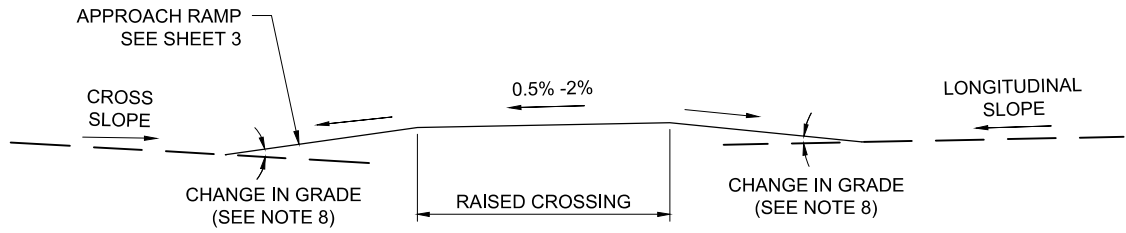

RAISED SIDE STREET

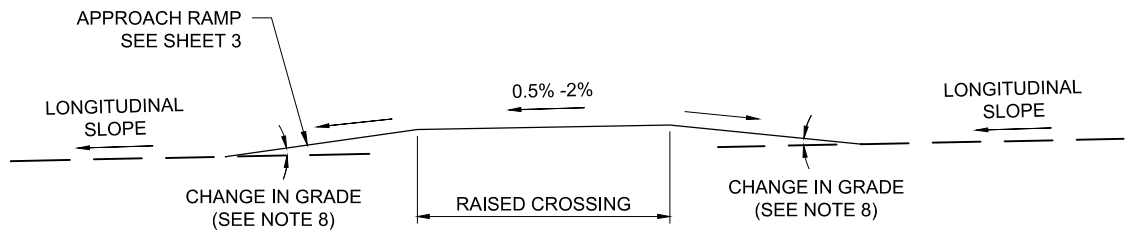

RAISED MID-BLOCK

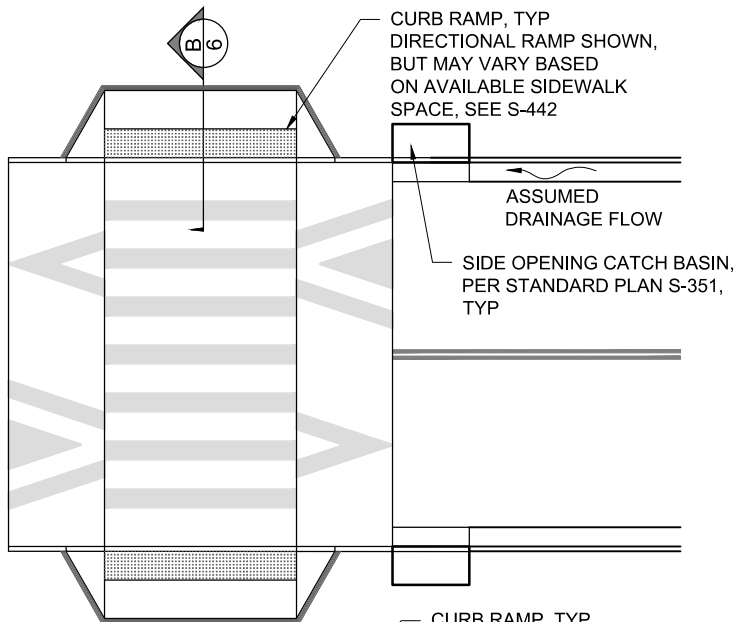

CASE A
NEW CATCH BASIN

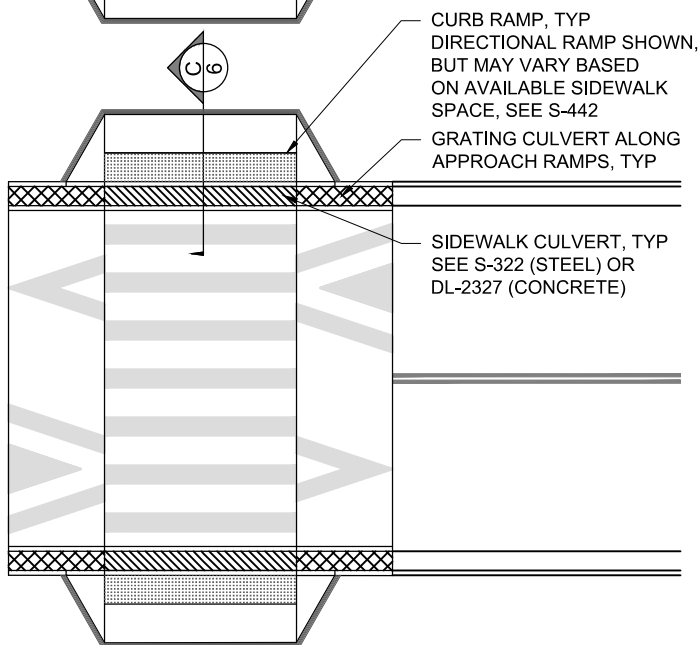

CASE B
SIDEWALK CULVERT

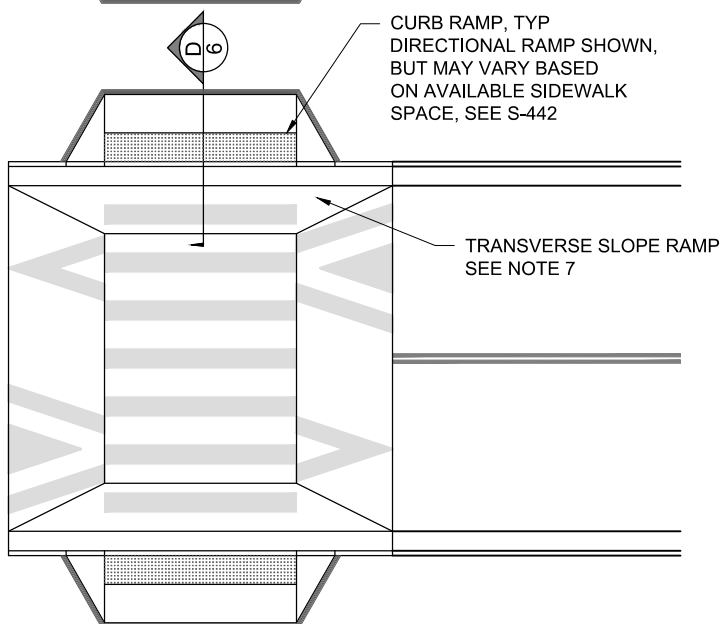

CASE C
EXISTING GUTTER FLOW

STORMWATER CONSIDERATIONS

C:\Users\ccueva\Desktop\Carlota\SSDI\Supplemental Design\Final\Raised Crossings_BOE-040220.dwg
4/2/2020 9:15 PM

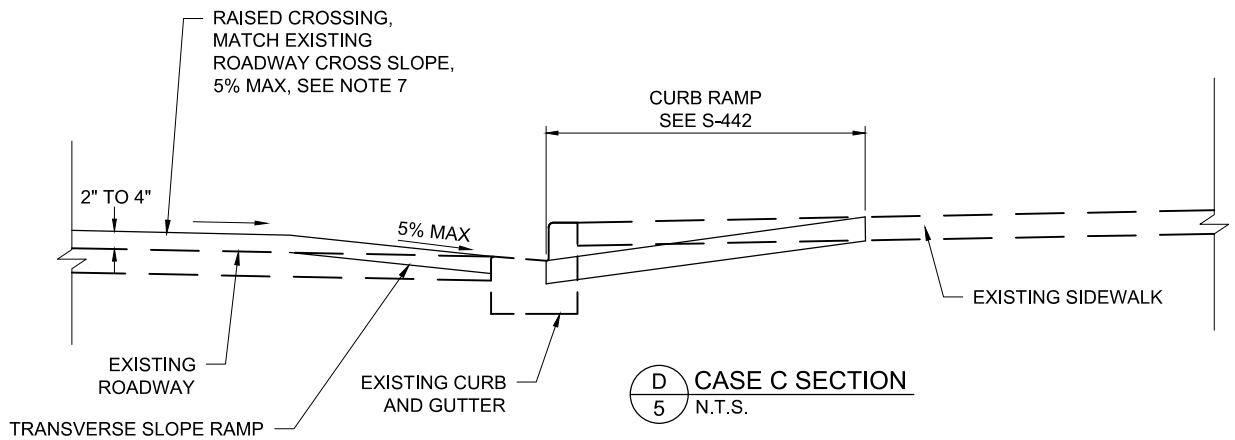
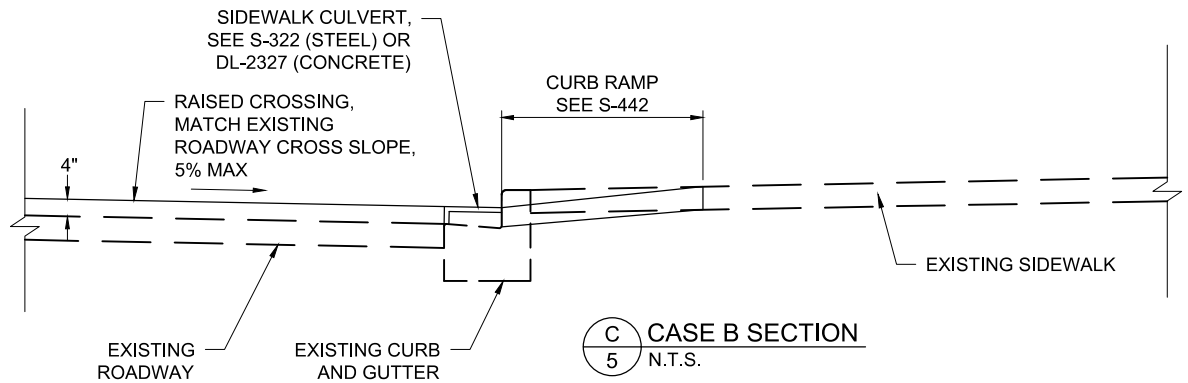
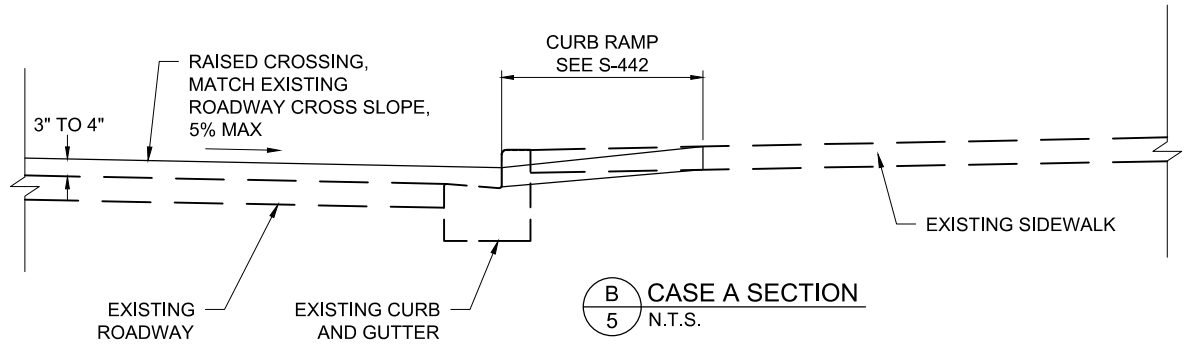

C:\Users\ccueva\OneDrive\Desktop\SSD\Supplemental Design\Final\Raised Crossings_BOE-040220.dwg
4/2/2020 9:15 PM

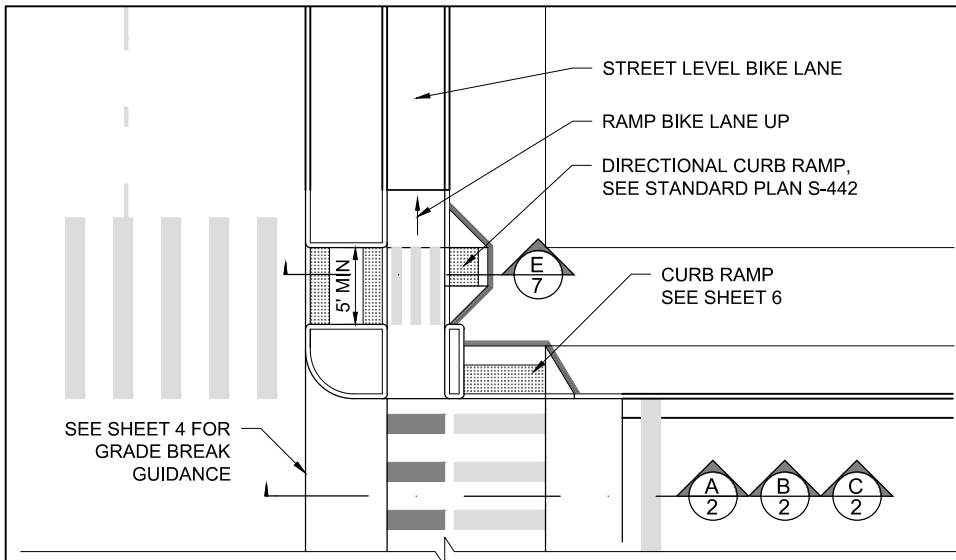

**RAISED SIDE STREET
WITH PROTECTED
BIKE LANE
CURB RAMP APPROACH**

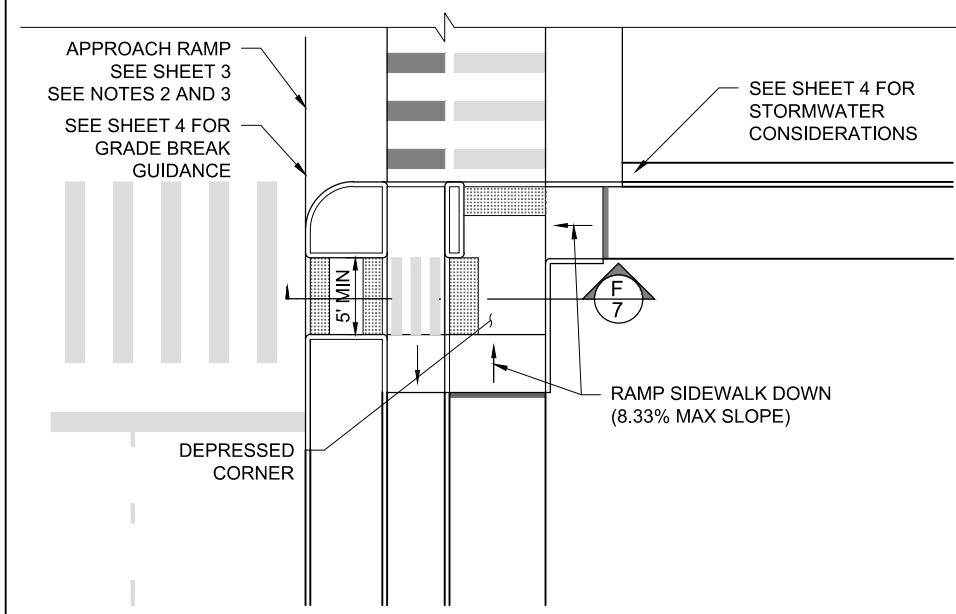

**RAISED SIDE STREET
WITH PROTECTED
BIKE LANE
DEPRESSED
CORNER APPROACH**

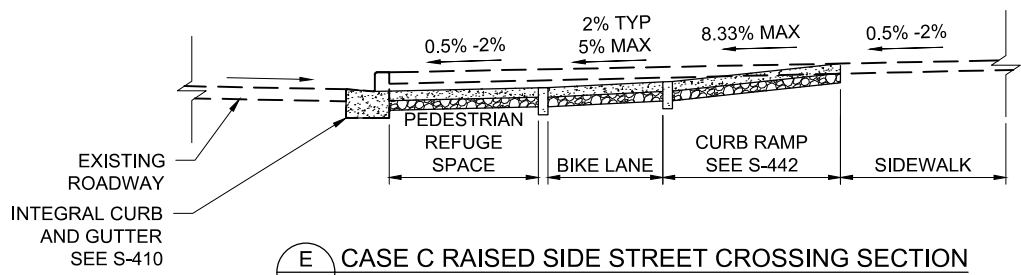

E
7 CASE C RAISED SIDE STREET CROSSING SECTION
N.T.S.

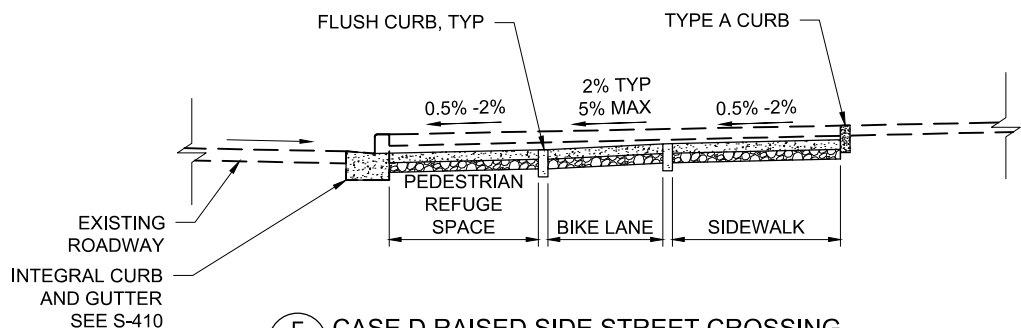

F
7 CASE D RAISED SIDE STREET CROSSING
N.T.S.

C:\Users\ccueva\Desktop\Cartosa\SSDI\Supplemental Design\Final\Raised Crossings_BOE-040220.dwg
4/2/2020 9:15 PM

NOTES

1. THE WIDTH OF THE TOP OF RAISED CROSSWALKS SHOULD MATCH THE WIDTH OF THE CONNECTING SIDEWALK, SHARED USE PATH, OR DESIRED CROSSWALK, BUT NOT LESS THAN 10' IN WIDTH.
2. BOTTOM EDGE OF RAISED CROSSING APPROACH RAMP TO BE ALIGNED WITH CURB LINE OF INTERSECTING STREET TO MINIMIZE IMPACTS TO SURFACE STORMWATER FLOWLINE.
3. MODIFICATIONS TO EXISTING STREET PAVING, COLD PLANE AND OVERLAY ASPHALT OR COMPLETELY RECONSTRUCT PAVING AS NECESSARY TO RESTORE A SMOOTH TRANSITION AND STREET CROWN (STANDARD PLAN S-433, SIMILAR), MATCH PAVING MATERIALS AND THICKNESS, SEE S-410 FOR STANDARD CURBS & GUTTERS, AND WARP NEW GUTTER TO JOIN INVERT AT INLET.
4. WHERE POSITIVE DRAINAGE CANNOT BE ACHIEVED, INSTALL SIDE-OPENING CATCH BASIN PER STANDARD PLAN S-351, AND CONNECT TO EXISTING STORMWATER CONVEYANCE SYSTEM.
5. A RAISED CROSSING SET BACK FROM THE MAIN STREET MAY CREATE A NEW LOW POINT IN FRONT OF THE RAISED CROSSING. DRAINAGE AND CATCH BASIN PLACEMENT WILL NEED TO BE CONSIDERED.
6. PLACE CROSSWALK 2' (MIN) FROM POLES, HYDRANTS, OR OTHER VERTICAL OBSTRUCTIONS.
7. THE CASE C SECTION (SEE SHEET 5) IS APPROPRIATE ON ROADWAYS WITH PARKING. THE RAISED CROSSING SHOULD REACH FULL HEIGHT OUTSIDE OF ACTIVE TRAVEL LANES. THE CASE 3 SECTION MAY NOT BE APPROPRIATE ON ABNORMALLY CROWNED ROADWAYS, WHERE THE CROSS SLOPE EXCEEDS 3.3%.
8. FOR STOP CONTROLLED SIDE STREET, THE MAXIMUM CHANGE IN GRADE IS 8%. FOR UNCONTROLLED OR SIGNALIZED INTERSECTIONS, OR FOR MID-BLOCK LOCATIONS, THE MAXIMUM CHANGE IN GRADE IS 5%.
9. CROSSWALK CROSS SLOPES SHOULD BE NO GREATER THAN 2%, HOWEVER, AT LOCATIONS WITHOUT STOP CONTROL THE CROSS SLOPES MAY BE 5% MAX. AND AT MIDBLOCK LOCATIONS THE CROSS SLOPE MAY MATCH THE EXISTING STREET GRADE.

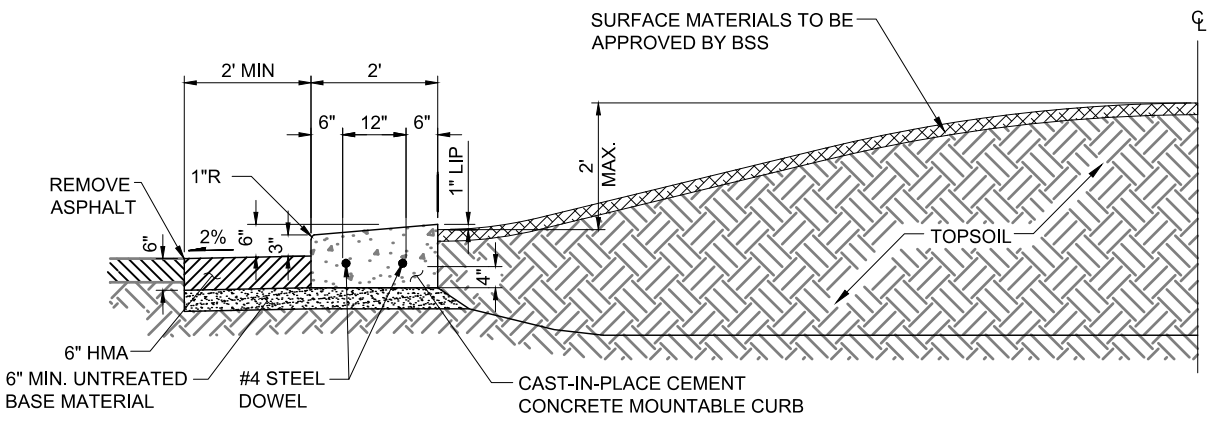
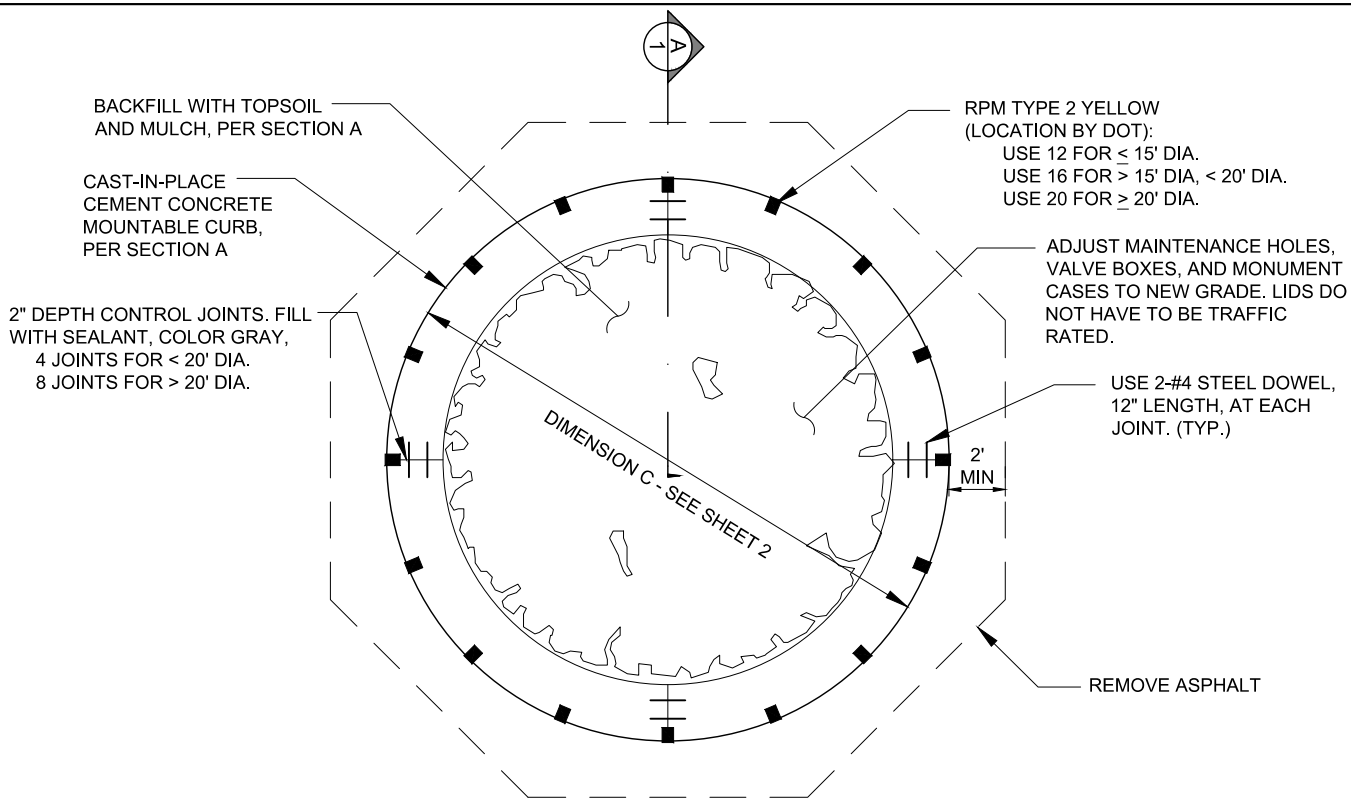

A
1 TYPICAL SECTION

NOTES

1. LANDSCAPING REQUIRES STREETS-LA REVIEW AND APPROVAL. PLANTINGS AND TREES MUST NOT INHIBIT INTERSECTION SIGHT DISTANCES BY ENSURING A CLEAR ZONE OF VISIBILITY BETWEEN 36 INCHES HIGH AND 80 INCHES HIGH FROM THE PAVEMENT ELEVATION.
2. MONUMENT PROTECTION/PRESERVATION: NOTIFY THE BOE SURVEY DIVISION PRIOR TO MONUMENT ADJUSTMENT. RAISE MONUMENT TO GRADE IN APPROPRIATE CASING.
3. CURB SHALL BE CONSTRUCTED OF PCC CONFORMING TO GREENBOOK SUBSECTION 201-1 AND 303-5.
4. THE TRAFFIC CONTROL DEVICES, PAVEMENT MARKINGS, AND SIGNS ASSOCIATED WITH THE CONSTRUCTION OF NEIGHBORHOOD TRAFFIC CIRCLES SHOULD FOLLOW THE GUIDANCE IN THE DOT NEIGHBORHOOD TRAFFIC CIRCLES STANDARD PLAN S-524.
5. INTERSECTIONS WITH MORE OR LESS THAN 4 LEGS REQUIRE ENGINEER APPROVAL.

\\bos-file01\60000\F006.02_LA Design Guide - OAK\PRODUCTION\CADD\PLANS\Traffic Circles_BOE_DOT.dwg 2/26/2020 2:26 PM

NEIGHBORHOOD TRAFFIC CIRCLES

**SUPPLEMENTAL
DESIGN GUIDE**

DETAIL **700**

SHEET 1 OF 2

CENTER ISLAND GEOMETRY

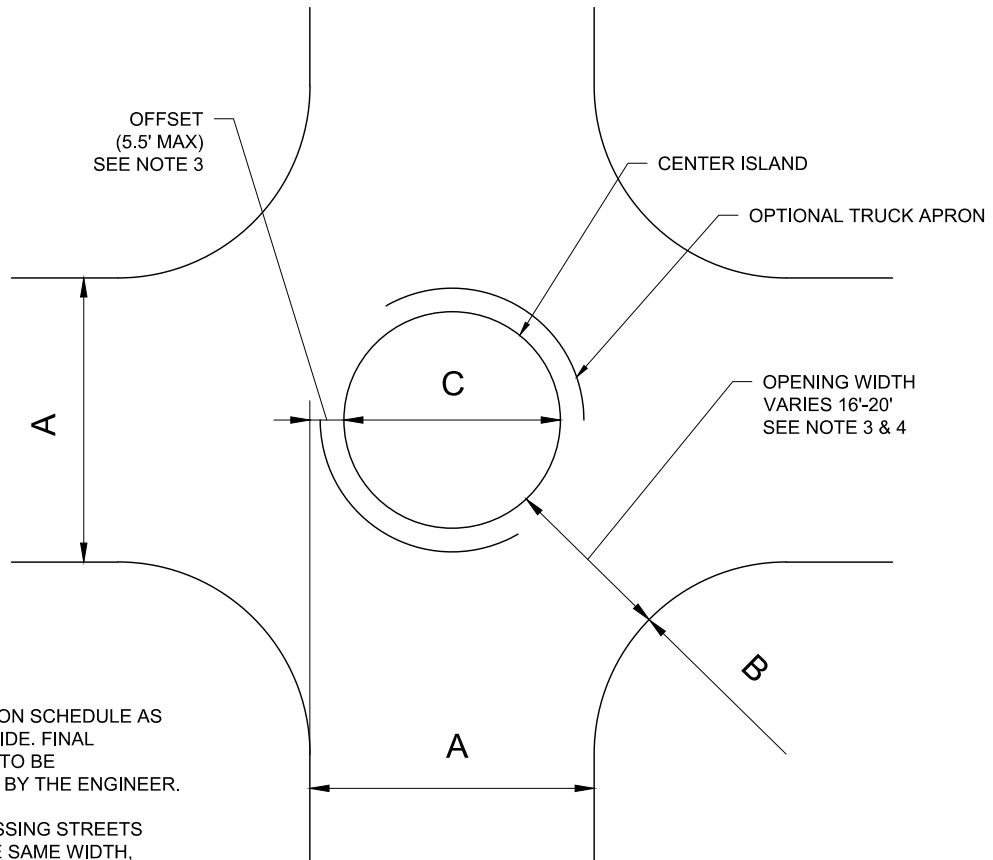

NOTES

1. USE DIMENSION SCHEDULE AS A DESIGN GUIDE. FINAL DIMENSIONS TO BE DETERMINED BY THE ENGINEER.
2. WHERE CROSSING STREETS ARE NOT THE SAME WIDTH, CONSIDER CURB EXTENSIONS ON WIDER ROAD TO CREATE CONSISTENT APPROACH WIDTHS.
3. FOR LOCATIONS WITH NON-STANDARD STREET WIDTHS, THE RELATIONSHIP BETWEEN THE OFFSET AND THE OPENING WIDTH IS DETERMINED BY THE OPENING WIDTH TABLE:
4. WHERE THE CIRCULATING WIDTH IS LESS THAN 20 FEET WIDE, A MOUNTABLE TRUCK APRON MAY BE REQUIRED.

OPENING WIDTH

OFFSET	OPENING WIDTH
5.5' (MAX)	16' (MIN)
5.0	17'
4.5	18'
4.0	19'
3.5 OR LESS	20' (MAX)

DIMENSIONS

A STREET WIDTH	B CURB RETURN RADIUS	C CENTER ISLAND DIAMETER
28' (HILLSIDE LIMITED STANDARD)	15' 20' 25'	18' 20' 22'
30' (LOCAL STREET LIMITED)	15' 20' 25'	20' 22' 24'
36' (LOCAL STREET STANDARD)	15' 20' 25'	27' 29' 33'
40' (COLLECTOR)	15' 20' 25'	32' 34' 38'

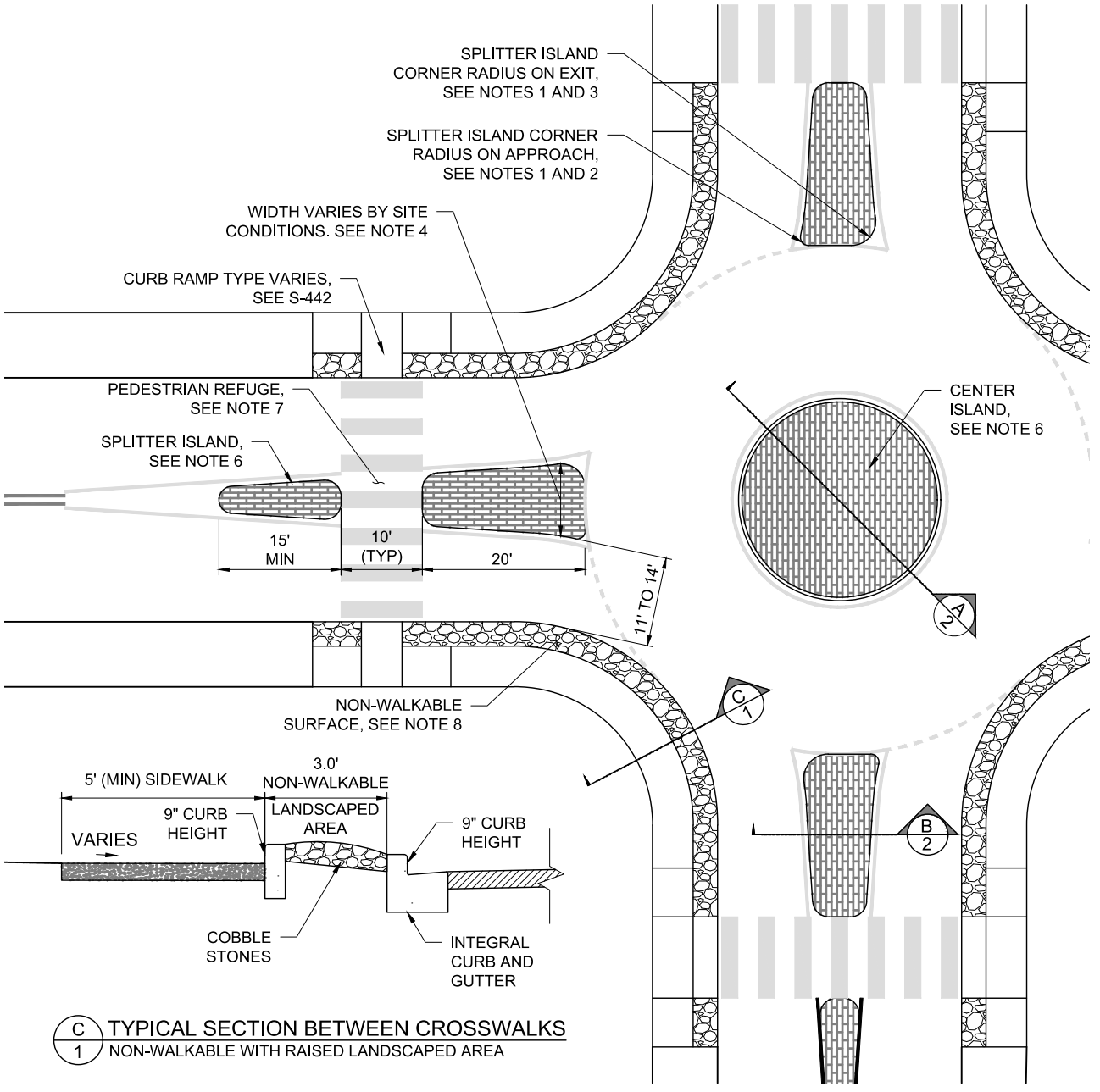

C
1 TYPICAL SECTION BETWEEN CROSSWALKS
NON-WALKABLE WITH RAISED LANDSCAPED AREA

NOTES:

1. ALL SPLITTER ISLAND CORNERS USE MINIMUM 1' RADIUS.
2. SPLITTER ISLAND CORNER ON APPROACH USE SMALL RADIUS (MIN 1') TO ENCOURAGE ENTRY DEFLECTION.
3. SPLITTER ISLAND CORNER ON EXIT USE LARGER RADIUS TO MINIMIZE DAMAGE FROM IMPACTS.
4. MOUNTABLE SPLITTER ISLANDS ARE PREFERRED AS SHOWN. PAINTED ISLANDS MAY BE USED WHEN SITE CONDITIONS LEAD TO SPLITTER ISLANDS LESS THAN 50 SF IN SIZE. COORDINATE WITH DOT.
5. INSTALL NEW CURB RAMPS AND CROSSWALKS PER STANDARD PLAN S-442. EXISTING RAMPS WITHIN THE CIRCULATING LANE MUST BE REMOVED.
6. PCC PAVEMENT WITHIN ISLANDS SHALL BE DISTINCT FROM THE ROADWAY AND SIDEWALKS. PCC APPLICATION MAY USE INTEGRAL COLOR, AND SURFACE TEXTURE MAY ALSO BE APPLIED.
7. IF THE SPLITTER ISLAND IS AT LEAST 6 FEET WIDE, DETECTABLE WARNING SHALL BE USED WITHIN THE REFUGE AREA. DETECTABLE WARNING SHALL BE 36" DEEP WHEN THE SPLITTER ISLAND IS 8' OR MORE IN WIDTH. BETWEEN 6' AND 8', THE DETECTABLE WARNING SHALL BE 24" DEEP.
8. A NON-WALKABLE SURFACE OR CURB SHOULD BE INSTALLED AT THE CORNERS TO PREVENT PEDESTRIANS FROM CROSSING AT THE INTERSECTION.

\\bos-file01\600001\F006.02_LA Design Guide - OAK\PRODUCTION\CADD\PLANS\Mini-Roundabout_BOE_DOT.dwg
 2/26/2020 2:46 PM

MINI ROUNDABOUTS

**SUPPLEMENTAL
DESIGN GUIDE**

DETAIL **710**

SHEET 1 OF 2

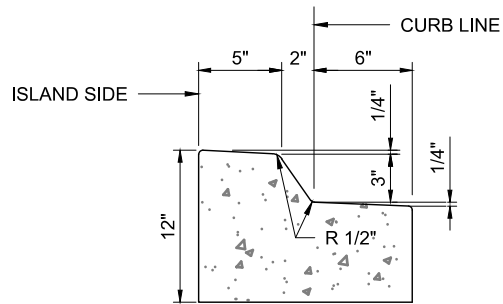

MOUNTABLE INTEGRAL CURB AND GUTTER

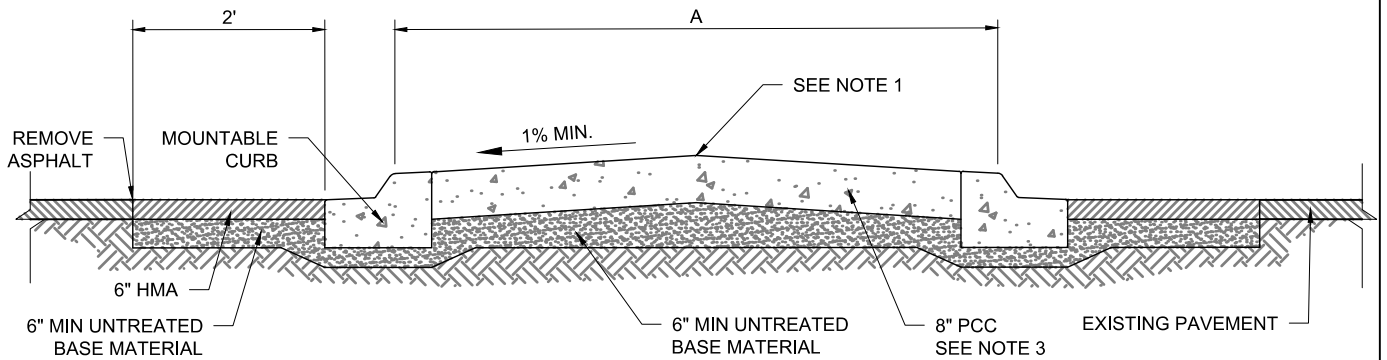

A CENTER ISLAND
 1 A. FOR DIAMETER DIMENSIONS OF THE CENTER ISLAND, SEE SHEET 3

B SPLITTER ISLAND
 1 A. WIDTH OF ISLAND VARIES. SEE PLAN VIEW DIMENSIONS.

NOTES:

1. CENTER OF ISLAND TYPICALLY DESIGNED AS HIGH POINT. IN CERTAIN LOCATIONS A CONSTANT SLOPE ACROSS ISLAND MAY BE DESIRABLE FINAL DIMENSIONS TO BE DETERMINED BY ENGINEER.
2. MOUNTABLE SPLITTER ISLANDS ARE PREFERRED, AS SHOWN. PAINTED ISLANDS MAY BE USED WHEN SITE CONDITIONS LEAD TO SPLITTER ISLANDS LESS THAN 50 SF IN SIZE.
3. PCC PAVEMENT WITHIN ISLANDS SHALL BE DISTINCT FROM THE ROADWAY AND SIDEWALKS. PCC APPLICATION MAY USE INTEGRAL COLOR, AND SURFACE TEXTURE MAY ALSO BE APPLIED.

\\bos-file01\600001\F006.02_LA Design Guide - OAK\PRODUCTION\CADD\PLANS\Mini-Roundabout_BOE_DOT.dwg
 2/26/2020 2:46 PM

APPENDIX B:
Supplemental Design Guide Details
Department of Transportation

CROSSWALK SIGN ASSEMBLY

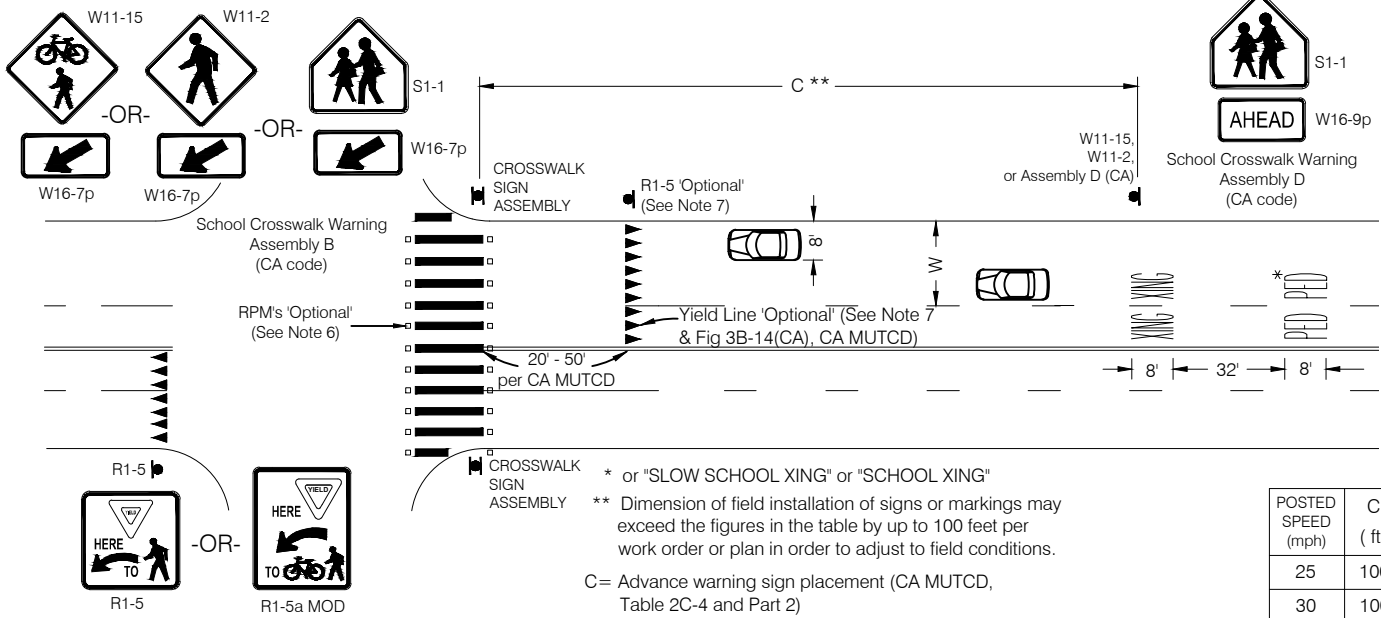

* or "SLOW SCHOOL XING" or "SCHOOL XING"
 ** Dimension of field installation of signs or markings may exceed the figures in the table by up to 100 feet per work order or plan in order to adjust to field conditions.
 C= Advance warning sign placement (CA MUTCD, Table 2C-4 and Part 2)

Install markings along striping and space at 4 1/2', 5', 5 1/2' and 6' C-C for 9', 10', 11' and 12' lanes, respectively
 2' white or yellow, centered on DYCL and lane lines

NOTES:

- IMPLEMENTATION**
 This standard plan applies to new installations and reinstallations of marked crosswalks and to marked crosswalks determined to be retained as a result of a study on multi-lane facilities. Use of signs shall be in coordination with all other controls shown on this plan.
- SIGN POSTING AT CROSSWALK**
 Crosswalk Sign Assembly signs shall be posted and should be positioned within ten feet of the crosswalk. These signs generally shall be posted back-to-back so that one sign is on the right and the other on the left. If a raised median with a width 6' or greater exists, the left sign shall be in the median. These signs should be 36" X 36". The W16-9p or W16-7p plates shall be 36" wide. All signs shall be fluorescent yellow-green.
- ADVANCE SIGN POSTING**
 Advance Pedestrian Crossing W11-15, W11-2 signs, or Assembly D (CA) signs shall be posted as shown and shall be fluorescent yellow-green. R1-5 signs shall be posted and positioned within ten feet of the yield limit line. These locations may be adjusted to accommodate field conditions. All signs should be 36" X 36".
- PAVEMENT MARKINGS**
 "PED XING" or "SCHOOL XING" pavement markings shall be installed as shown except the yellow "SLOW SCHOOL XING" pavement markings shall be installed in advance of uncontrolled yellow school crosswalks. If the crosswalk spacing is less than 500 feet, only one set of pavement markings is required in advance of the first crosswalk.
- MIDBLOCK CROSSWALKS**
 This standard plan also applies to uncontrolled approaches to midblock crosswalks.

- RAISED PAVEMENT MARKINGS (RPM)**
 Install RPMs one each side of crosswalk bar facing approach lanes. Two-way clear (white) or two-way amber (yellow) per CALTRANS standards and specifications may be installed corresponding to the crosswalk color.
- R1-5 (YIELD HERE TO PEDESTRIANS) SIGNS AND YIELD LINES**
 For uncontrolled locations with more than one lane in each direction of travel, advance yield lines may be used. Yield lines shall be supplemented with R1-5 signs.

APPROVED		7-08-20
 for Seleta Reynolds, General Manager		
CITY OF LOS ANGELES DEPARTMENT OF TRANSPORTATION		
TRAFFIC CONTROLS FOR MARKED CROSSWALKS ON UNCONTROLLED APPROACHES		1 / 4
CKD. Priv. Engr.	SR. T.E. JV	PR. T.E. BS
DWN. Priv. Engr.	T.E. MN	S-481.0

W (ft)	POSTED SPEED (mph)			
	25	30	35	40
	CALCULATED A DISTANCES (ft)			
18	56	71	88	107
19	51	65	81	98
20	47	60	74	90
21	44	56	69	84
22	41	52	65	78
23	38	49	61	74
24	36	46	57	69

$A = 4B / (W - 7)$ = Curb stopping prohibition necessary for motorist to see a pedestrian at a point 4' into the roadway. LADOT practice is to install 50 feet of red curb on arterial approaches to side streets, measured from the side street curb line prolongation. Install this minimum dimension whenever the calculated A distance results in a lesser dimension. (See Note 1)
 B = Safe stopping distance = $1.47 VT + 1.075 V^2/a$
 V = Posted speed + 5mph (Chart listings calculated on posted speed + 5mph)
 T = Perception - Reaction time of 1.5 seconds (Driver previously alerted with advance sign and pavement markings)
 a = Deceleration rate = 11.2 ft/s^2 (ASSHTO Policy on Geometric Design of Highways & Streets, Stopping Sight Distance)
 W = Curb lane width (Driver is assumed to be 3' from lane line)

POSTED SPEED (mph)	B (ft)
25	153
30	195
35	242
40	294

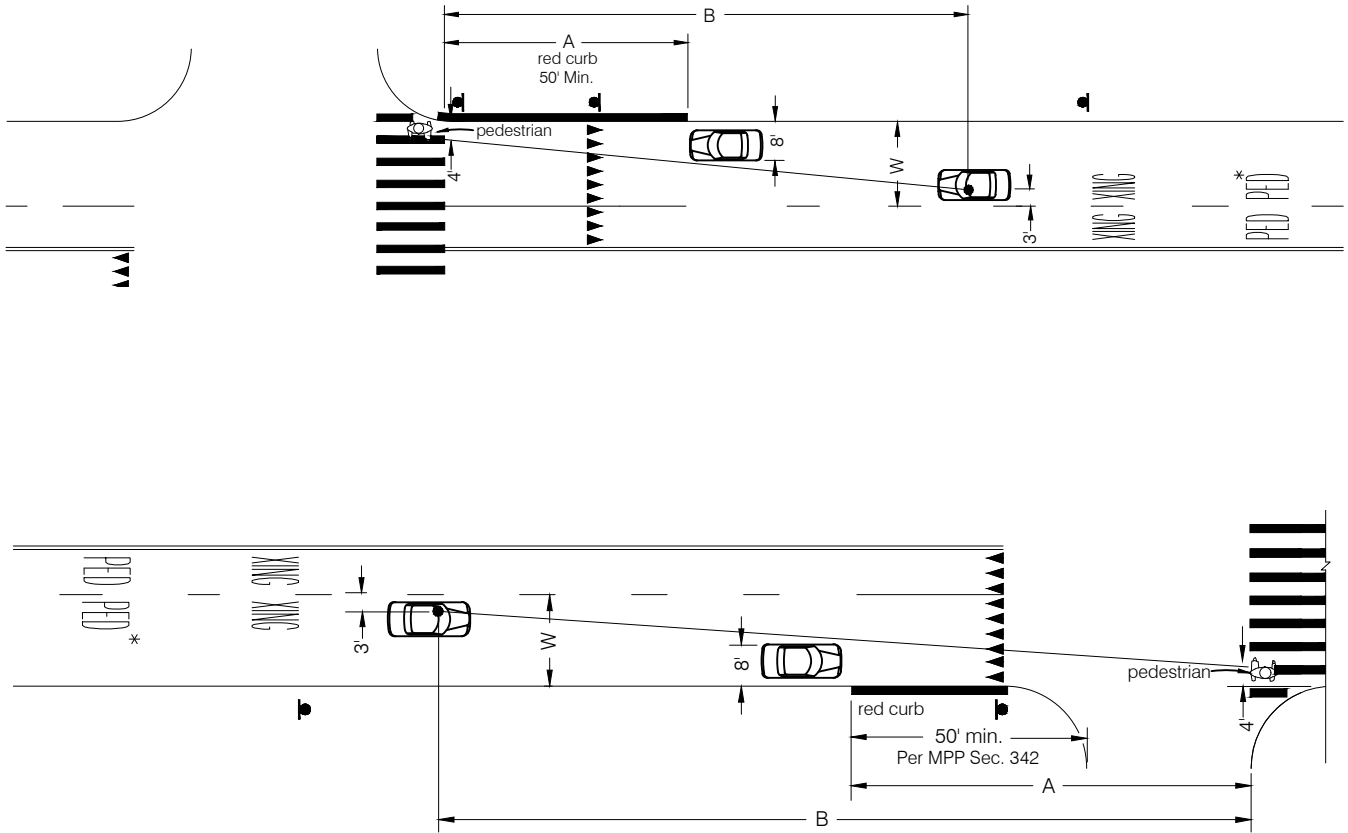

NOTES:

- ONE-WAY STREETS**
 Because one-way streets place drivers closer to the curb on the left side of the roadway, use $A = 4B / (W - 11)$ for left side pedestrian approach. This distance is not shown above.
- SIGNS**
 See Sheet 1 for appropriate signs.

W (ft)	POSTED SPEED (mph)			
	25	30	35	40
	CALCULATED A DISTANCES (ft)			
18	19	24	30	37
19	17	22	27	33
20	15	20	24	29
21	14	18	22	27
22	13	16	20	25
23	12	15	19	23
24	11	14	17	21

$A=B/(W-10)$ = Curb stopping prohibition necessary for a motorist to see a pedestrian at the curblines of the curb extension. This formula assumes that the curb extension is 7' wide compared to the 8' wide parking lane.

POSTED SPEED (mph)	B (ft)
25	153
30	195
35	242
40	294

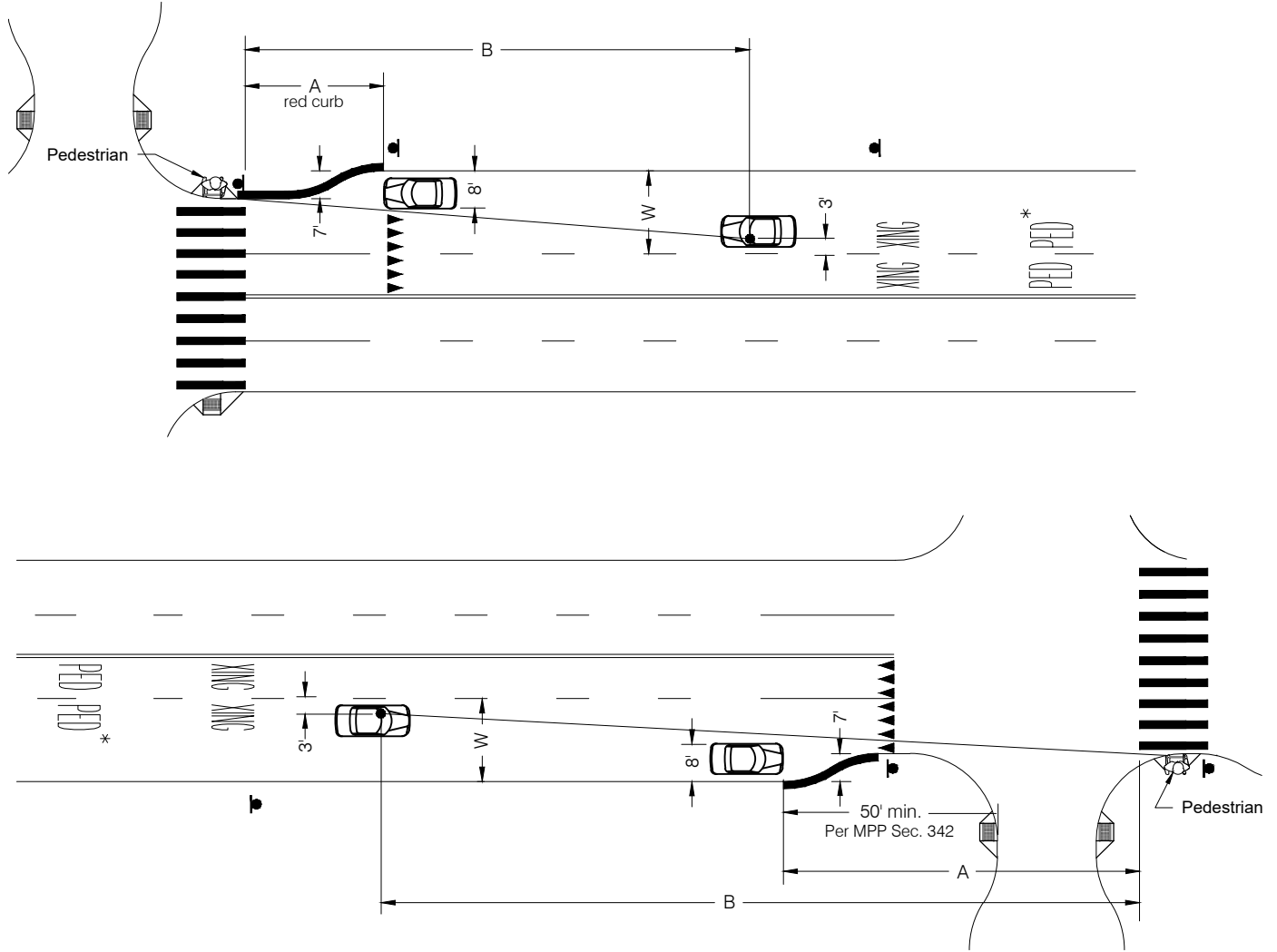

NOTES:

- SIGNS**
See Sheet 1 for appropriate signs.

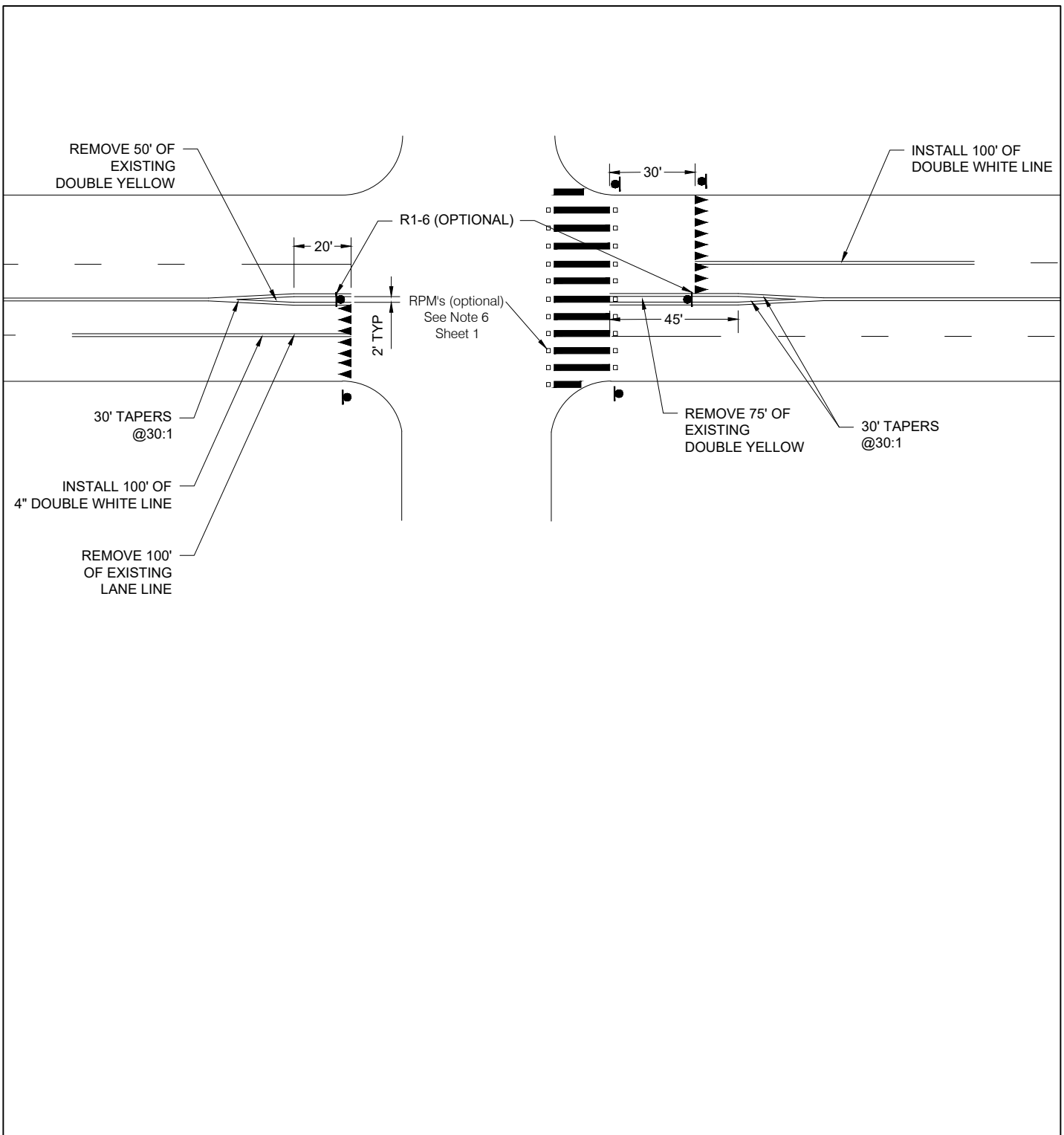

NOTES:

- 1. **SIGNS**
See Sheet 1 for appropriate signs.

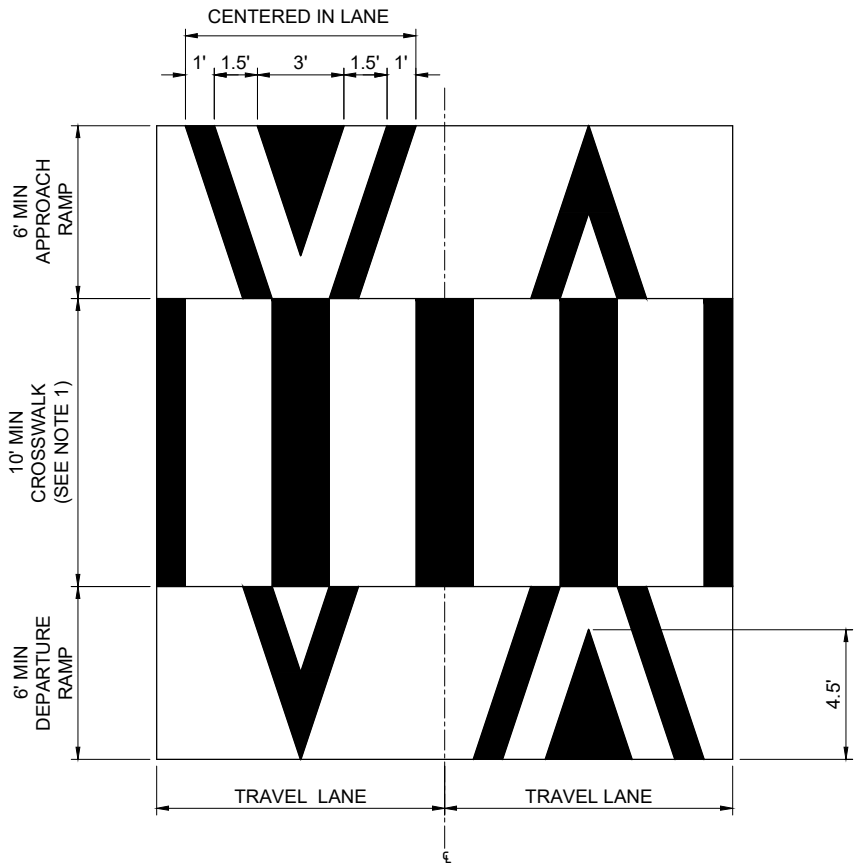

RAISED CROSSWALK MARKING (CHEVRON III)

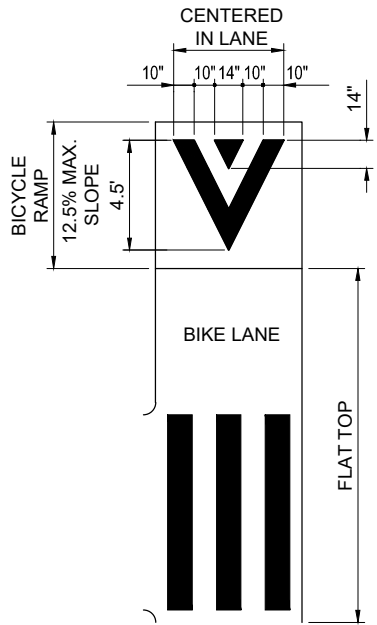

BICYCLE RAMP MARKING (CHEVRON IV)

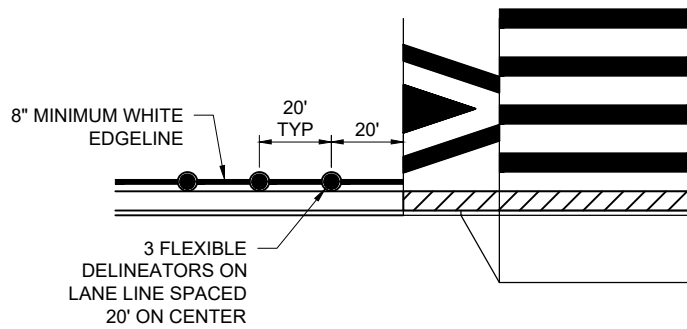

SIDEWALK CULVERT MARKINGS

APPROVED		02-20-2020
for Seleta Reynolds, General Manager		
CITY OF LOS ANGELES DEPARTMENT OF TRANSPORTATION		
RAISED CROSSWALKS		1 3
CKD. Priv. Engr.	SR. T.E. JV	PR. T.E. BS
DWN. Priv. Engr.	T.E. MN	S-483.1

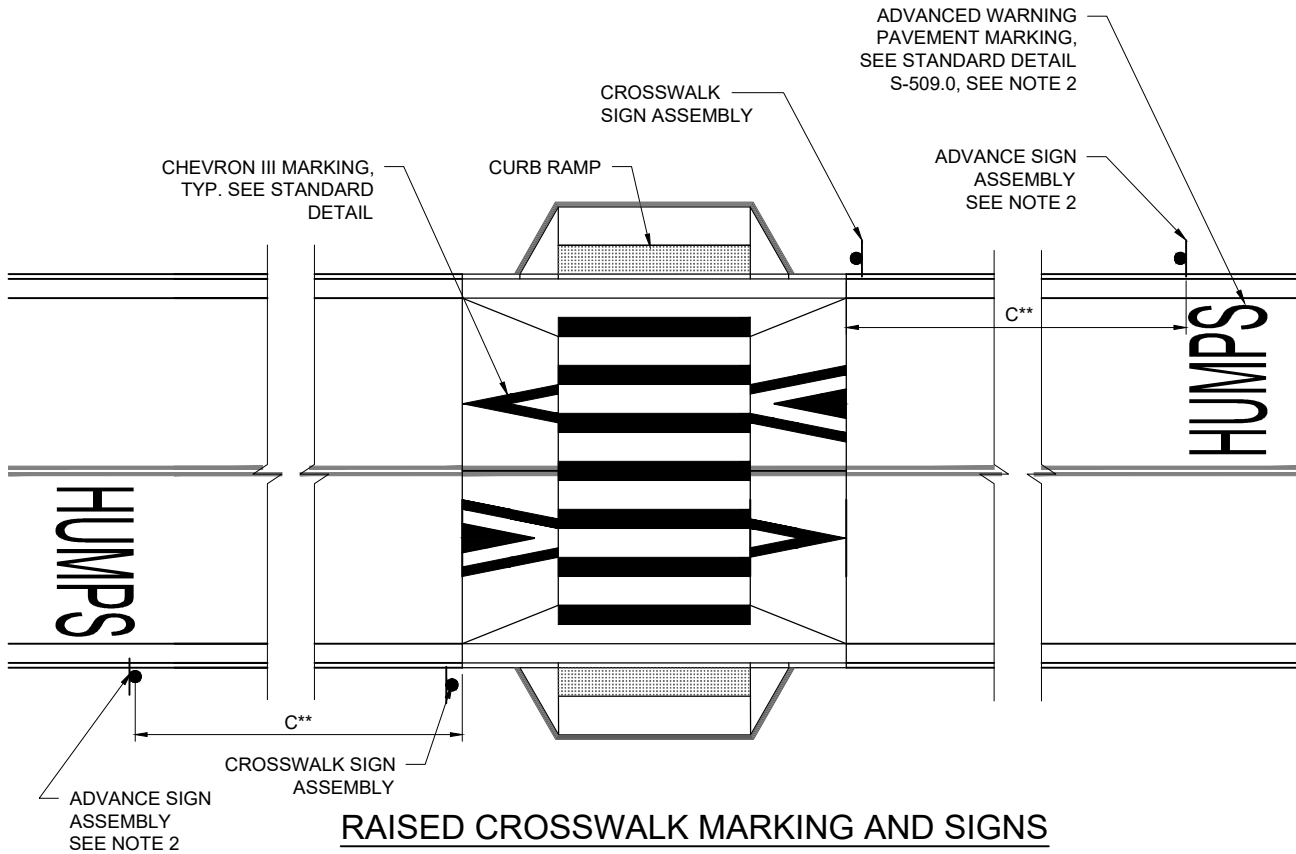

W11-2



W11-15



W17-1bP



W17-1bP



W16-7P



W16-9P



W13-1 *

ADVISORY SPEED PLAQUES

- *W13-1 (15 MPH)
- W13-1 (20 MPH)
- W13-1 (25 MPH)
- W13-1 (30 MPH)



*AS APPROPRIATE FOR RAISED CROSSWALK DESIGN SPEED

CROSSWALK ASSEMBLY

ADVANCE ASSEMBLY

RAISED CROSSWALK SIGN ASSEMBLIES

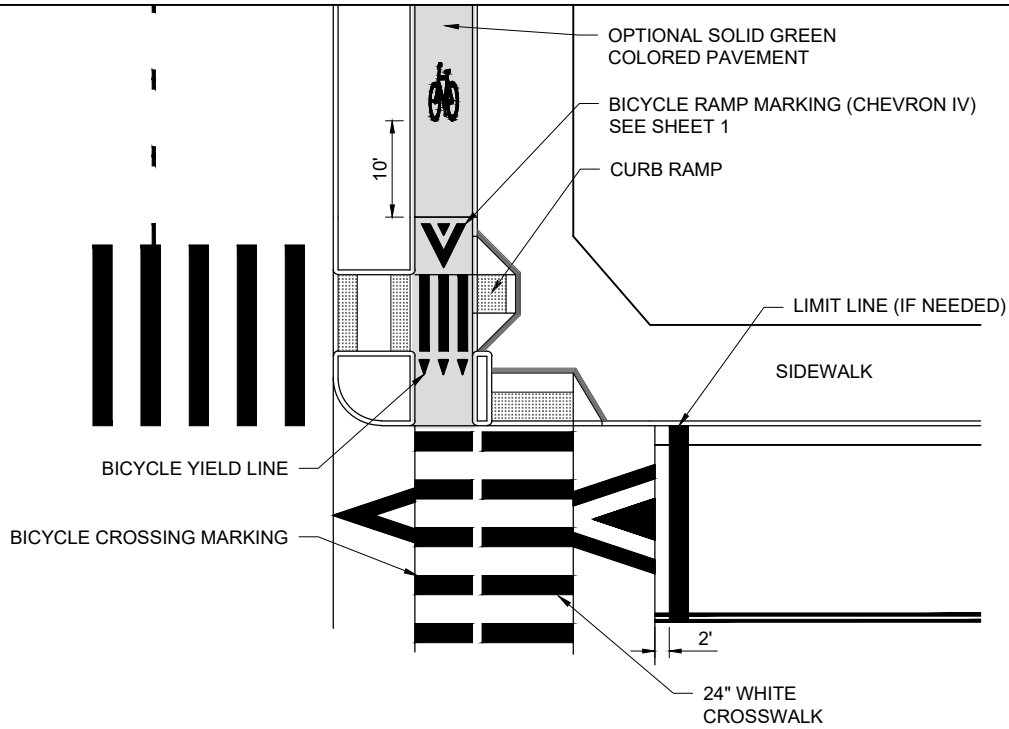

**RAISED SIDE STREET CROSSWALK
STANDARD CURB RAMP**

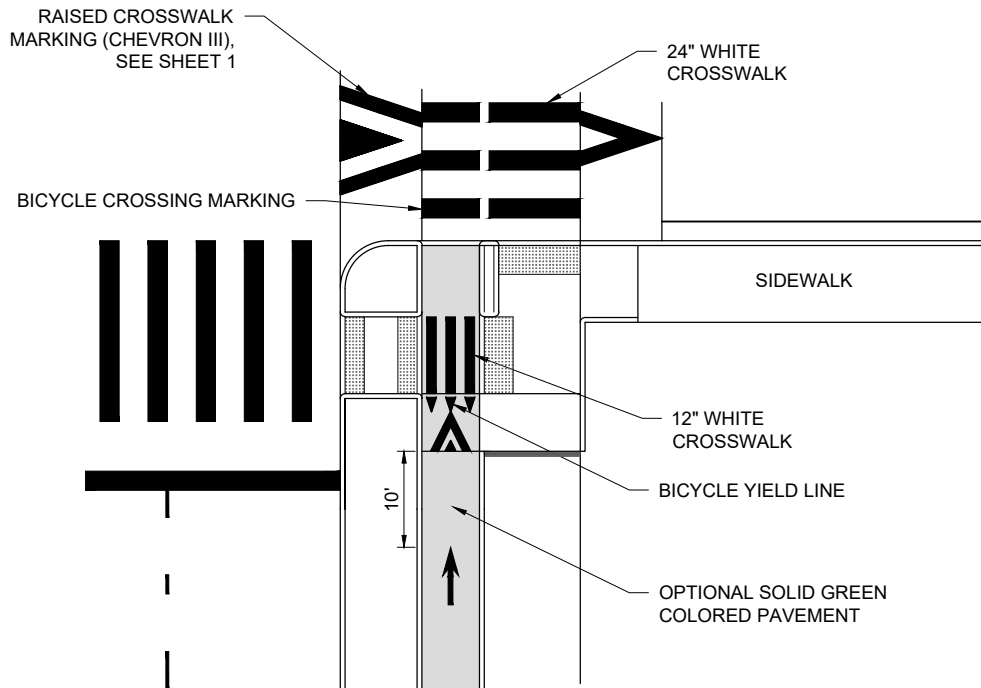

**RAISED SIDE STREET CROSSWALK
DEPRESSED CORNER**

NOTES

1. THE WIDTH OF THE TOP OF RAISED CROSSWALKS SHOULD MATCH THE WIDTH OF THE CONNECTING SIDEWALK, SHARED USE PATH, OR DESIRED CROSSWALK, BUT NOT LESS THAN 10' IN WIDTH.
2. THE PLACEMENT OF ADVANCED WARNING SIGNS AND MARKINGS SHALL FOLLOW THE GUIDANCE FOR ADVANCED SIGN POSTING (C**) SHOWN ON S-481.0.
3. SEE CITY OF LOS ANGELES SUPPLEMENTAL STREET DESIGN GUIDE, DETAIL 600 FOR RAISED CROSSING DETAILS.

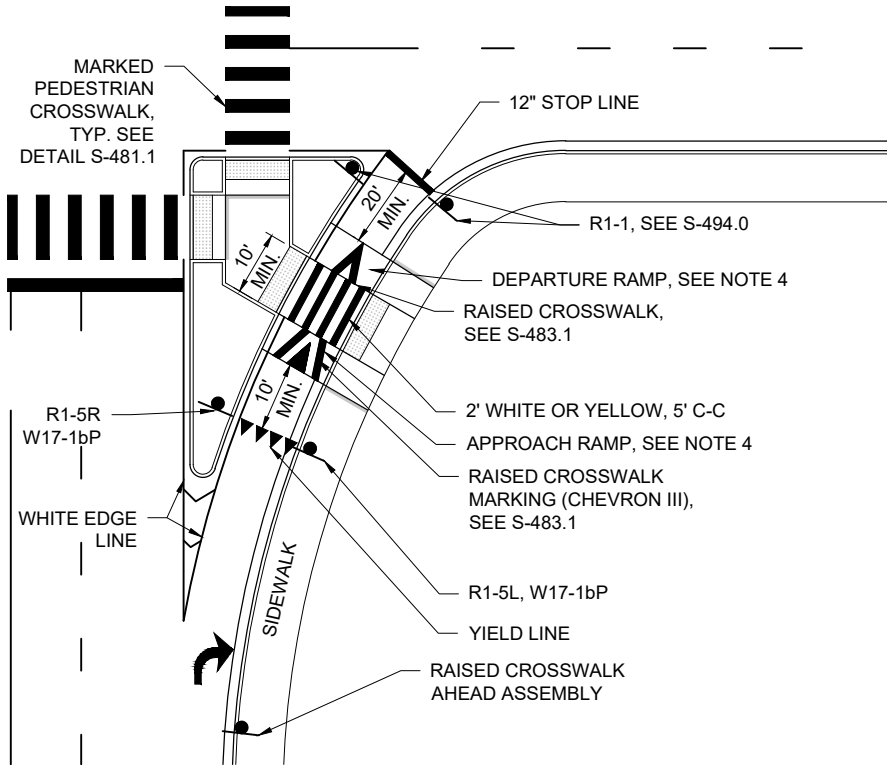

PEDESTRIAN ISLAND CHANNELIZED RIGHT TURN

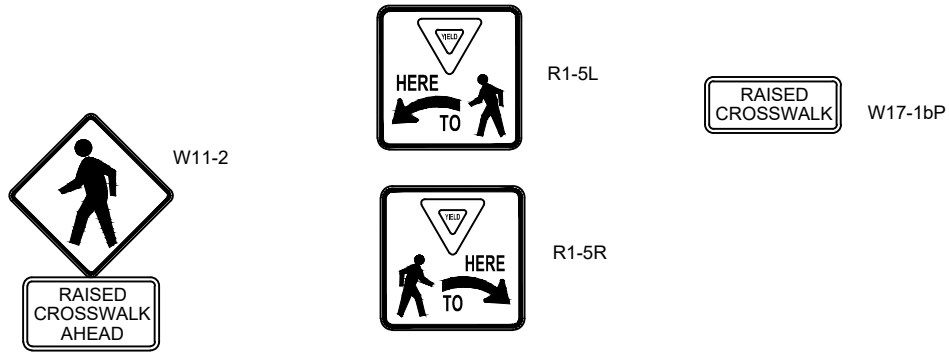

**RAISED CROSSWALK AHEAD
ASSEMBLY DETAIL**

APPROVED		02-20-2020
for Seleta Reynolds, General Manager		
CITY OF LOS ANGELES DEPARTMENT OF TRANSPORTATION		
CHANNELIZED RIGHT TURNS WITH RAISED CROSSWALKS		1 2
CKD. Priv. Engr.	SR. T.E. JV	PR. T.E. BS
DWN. Priv. Engr.	T.E. MN	S-494.1

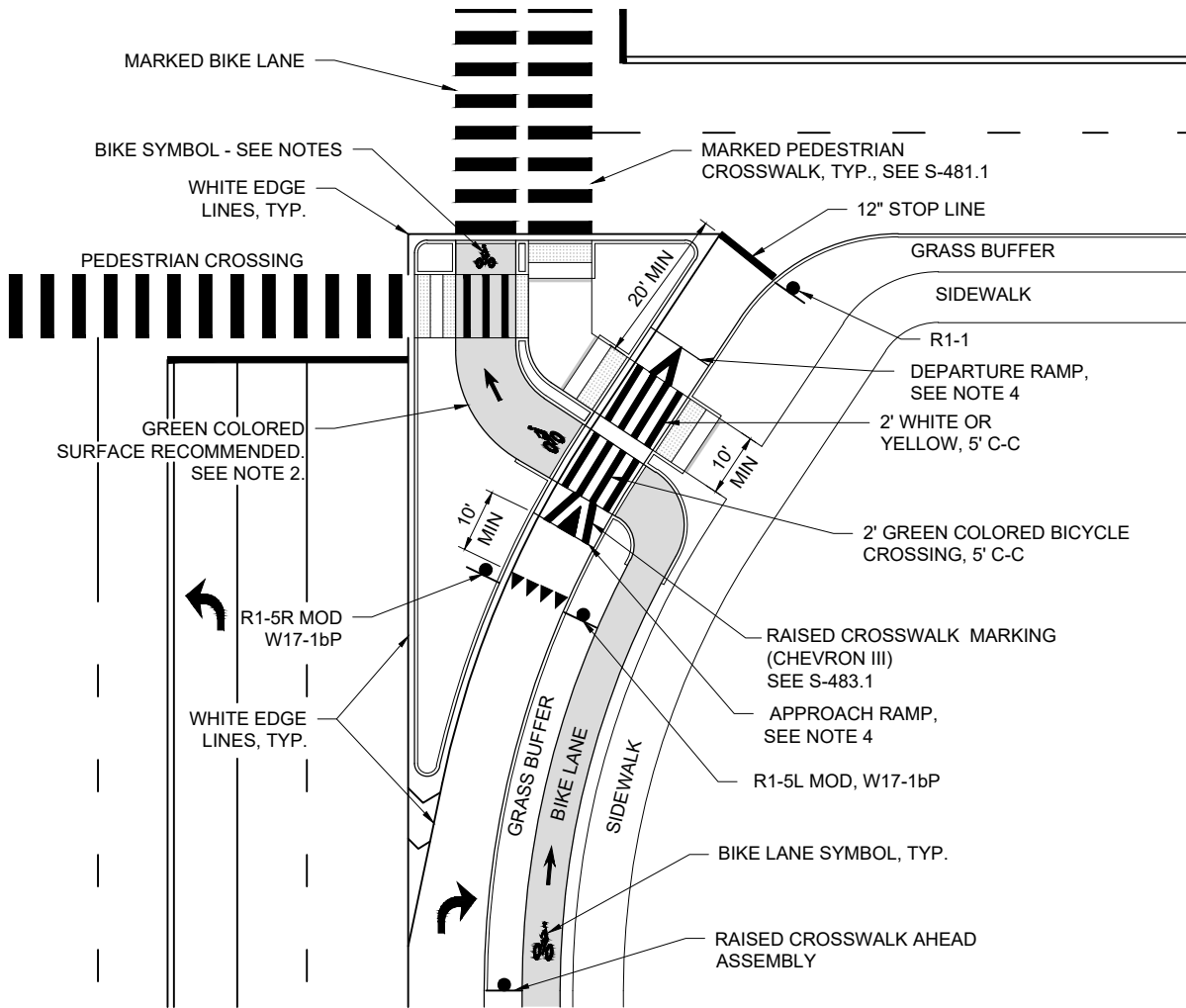

PEDESTRIAN ISLAND CHANNELIZED RIGHT TURN



R1-5L MOD



R1-5R MOD

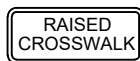

W17-1bP

NOTES:

1. BIKE LANE SYMBOLS ARE RECOMMENDED TO CLARIFY THE INTENDED OPERATION OF THE BIKE LANE SPACE.
2. OPTIONAL USE OF GREEN COLORED PAVEMENT TO ENHANCE VISIBILITY AND CONSPICUITY OF BICYCLE LANE. GREEN COLORED PAVEMENT MAY BE INSTALLED FOR THE ENTIRE LENGTH OF THE BICYCLE LANE OR FOR ONLY A PORTION (OR PORTIONS) OF THE BICYCLE LANE. ALL GREEN COLORED PAVEMENT SHOULD COMPLY WITH FHWA INTERIM APPROVAL FOR OPTIONAL USE OF GREEN COLORED PAVEMENT FOR BIKE LANES (IA-14) AND APPROVED BY LADOT.
3. SEE CITY OF LOS ANGELES SUPPLEMENTAL STREET DESIGN GUIDE, DETAIL 100 AND DETAIL 600 FOR PEDESTRIAN/BICYCLIST ISLAND AND RAISED CROSSWALK DETAILS.
4. APPROACH AND DEPARTURE RAMPS SHOULD BE A MINIMUM OF 6' IN LENGTH. WHERE WB-50'S OR BUSES ARE EXPECTED THE RAMP LENGTH SHOULD BE 9' MINIMUM.

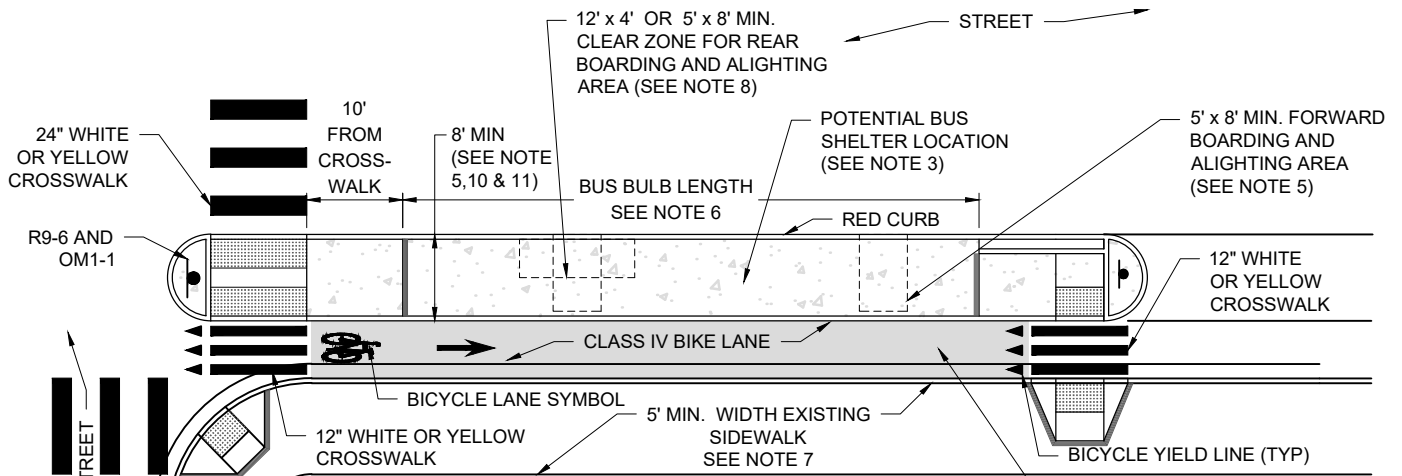

**TYPE II FLOATING BUS BULB
STREET ELEVATION BIKE LANE
INTEGRATED WITH STREET CROSSING**

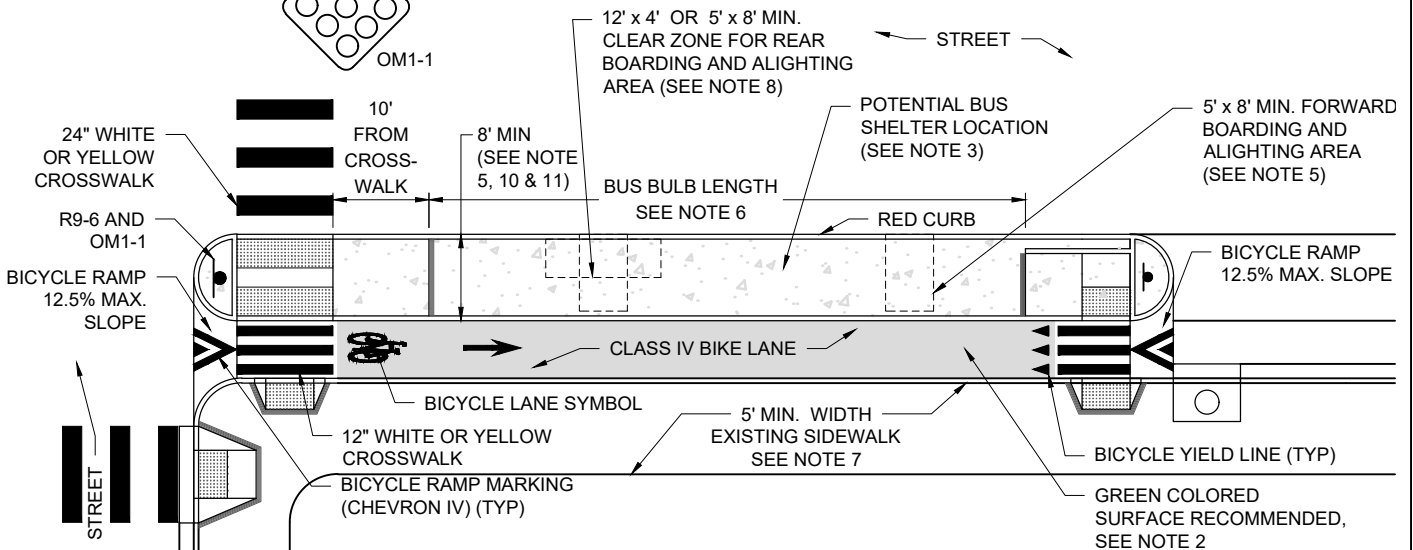
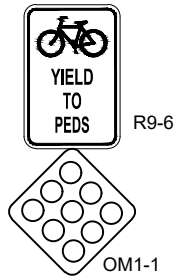

**TYPE II FLOATING BUS BULB
INTERMEDIATE ELEVATION BIKE LANE**

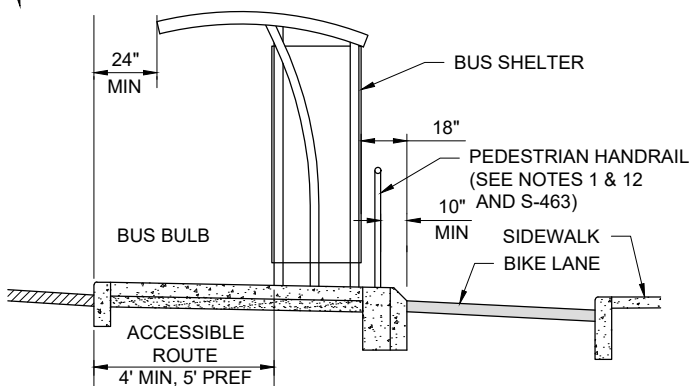

**SHELTER AND RAILING
PLACEMENT GUIDANCE**

APPROVED		02-20-2020
for Seleta Reynolds, General Manager		
CITY OF LOS ANGELES DEPARTMENT OF TRANSPORTATION		
BUS BULBS		1 4
CKD. Priv. Engr.	SR. T.E. JV	PR. T.E. BS
DWN. Priv. Engr.	T.E. MN	S-523.0

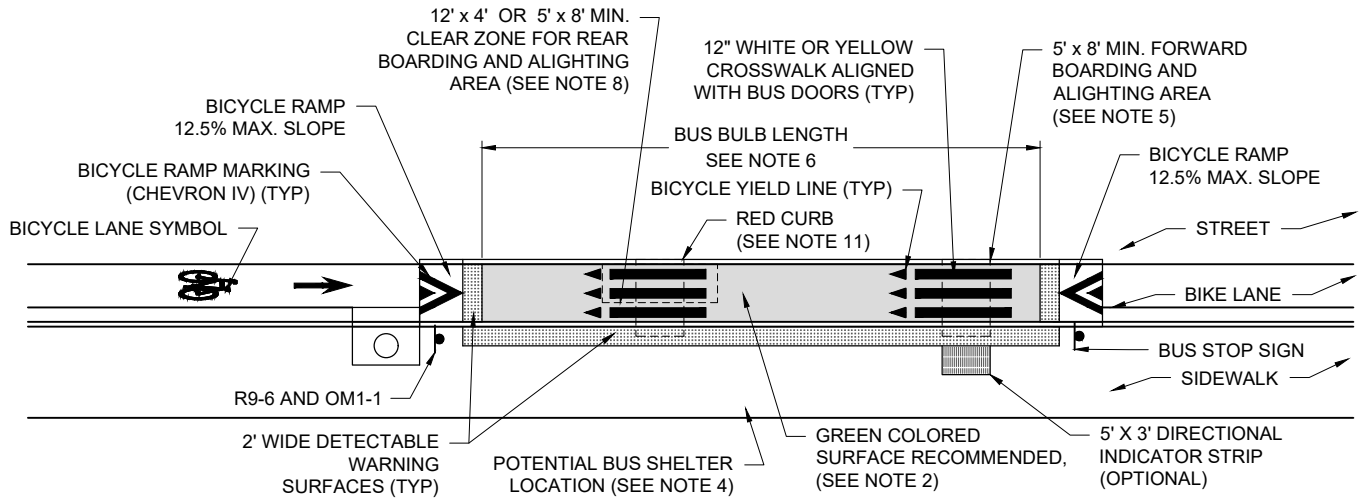

**CONSTRAINED TYPE II BUS BULB
RAISED BIKE LANE**

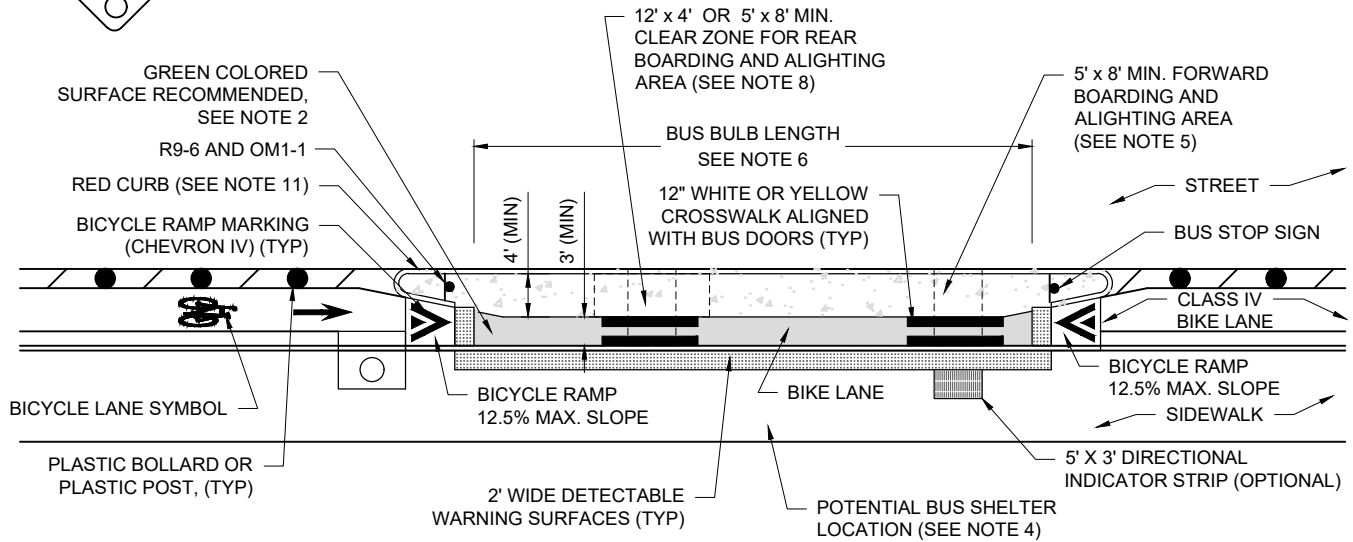
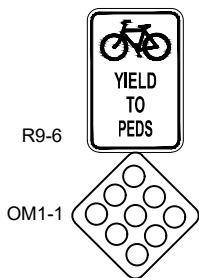

**CONSTRAINED TYPE II BUS BULB
RAISED BIKE LANE WITH NARROW BOARDING AND ALIGHTING AREA**

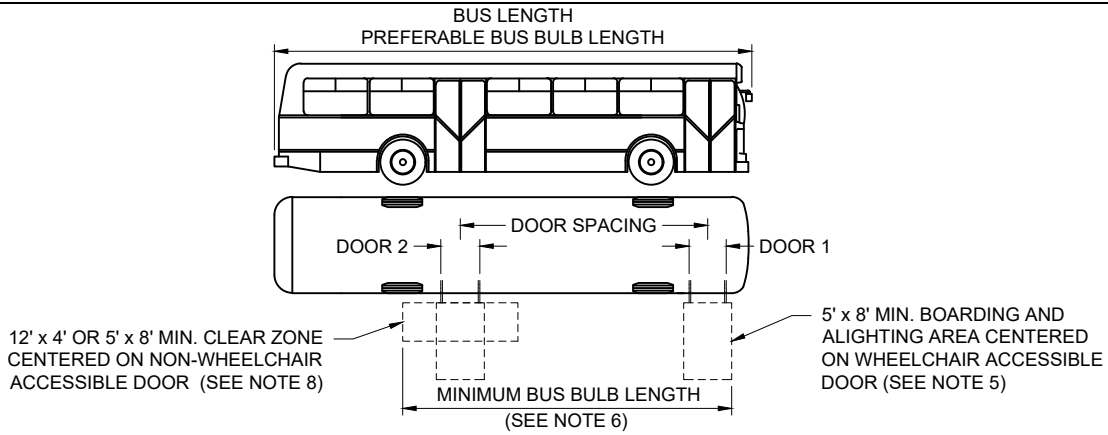

DOOR 1 (FRONT DOOR) DEPICTED AS WHEELCHAIR ACCESSIBLE DOOR

AGENCY	BUS SERIES	LENGTH (ft)	DOOR SPACING**		FRONT DOOR WIDTH		REAR DOOR WIDTH		ACCESSIBLE DOOR*	TOTAL LENGTH OF DOORS AND SPACE BETWEEN (ft)	MINIMUM BUS BULB LENGTH (ft)
			1-2 (in)	1-2 (ft)	(in)	(ft)	(in)	(ft)			
DASH LADOT	EZRIDER	32	148	12.33	36	3	36	3	REAR*	15.33	21
	EZRIDER II	32	156	13.00	36	3	36	3	FRONT	16.00	22
	AXESS	35	180	15.00	36	3	36	3	FRONT	18.00	24
	GILLIG	30	165	13.75	36	3	30	2.5	FRONT	16.50	23
	K9LR	32	156	13.00	36	3	36	3	FRONT	16.00	22
	K7M	30	146	12.17	44	3.67	47	3.92	REAR*	15.96	21
	PROTERRA	35	221	18.42	33	2.75	39	3.25	FRONT	21.42	27
METRO	1001-1005	40	237	19.75	30	2.5	30	2.5	FRONT	22.25	29
	3850-4199	40	249	20.75	30	2.5	30	2.5	FRONT	23.25	30
	4200-4205	42	195	16.25	36	3	36	3	FRONT	19.25	25
	5300-5522	40	257	21.42	30	2.5	30	2.5	FRONT	23.92	30
	5600-6149	40	249	20.75	30	2.5	30	2.5	FRONT	23.25	30
	7000-7949	40	207	17.25	30	2.5	30	2.5	FRONT	19.75	26
	7980	40	208	17.33	30	2.5	30	2.5	FRONT	19.83	26
	8000-8650	45	255	21.25	30	2.5	30	2.5	FRONT	23.75	30

* DRAWING DEPICTS ACCESSIBLE DOOR AT FRONT OF BUS. IF ACCESSIBLE DOOR IS AT REAR OF BUS, 5' x 8' BOARDING AND ALIGHTING AREA MUST BE LOCATED AT REAR DOOR AND 12' x 4' BOARDING ALIGHTING AREA WILL BE LOCATED AT FRONT DOOR. ENSURE THAT ACCESSIBLE AREAS ARE PROVIDED BASED ON ALL BUSES EXPECTED TO USE THE BUS STOP.

** DOOR SPACING MEASURED CENTER TO CENTER ON THE DOORS.

BUS BULB LENGTHS (STANDARD BUS)

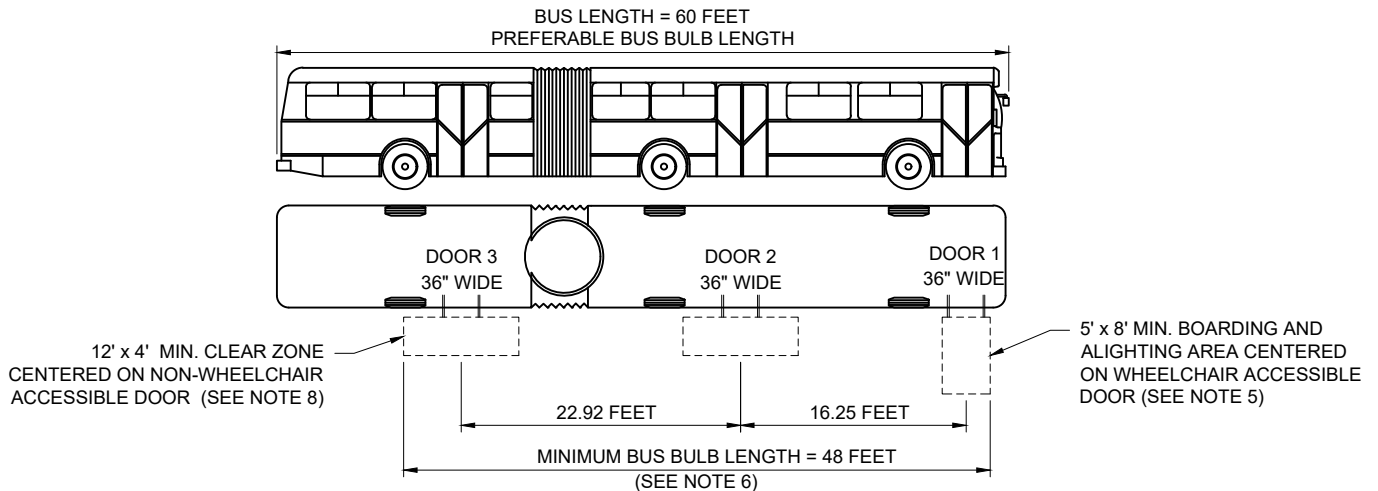

BUS BULB LENGTHS (METRO 9200-9595 SERIES ARTICULATED BUS)

CITY OF LOS ANGELES DEPARTMENT OF TRANSPORTATION	Title BUS BULBS	Drawing No. S-523.0	3
			4

NOTES

1. SEE CITY OF LOS ANGELES SUPPLEMENTAL STREET DESIGN GUIDE, DETAIL 400 FOR BUS BULB DETAILS.
2. OPTIONAL USE OF GREEN COLORED PAVEMENT TO ENHANCE VISIBILITY AND CONSPICUITY OF BICYCLE LANE. GREEN COLORED PAVEMENT MAY BE INSTALLED FOR THE ENTIRE LENGTH OF THE BICYCLE LANE OR FOR ONLY A PORTION (OR PORTIONS) OF THE BICYCLE LANE. ALL GREEN COLORED PAVEMENT SHOULD COMPLY WITH FHWA INTERIM APPROVAL FOR OPTIONAL USE OF GREEN COLORED PAVEMENT FOR BIKE LANES (IA-14), AND APPROVED BY LADOT.
3. BUS SHELTERS LOCATED ON BUS BULBS MUST BE CHOSEN AND LOCATED TO MAINTAIN A MINIMUM 4 FOOT CLEAR ACCESSIBLE PATH BETWEEN THE SHELTER, CROSSWALKS, AND BUS BOARDING AND ALIGHTING AREAS.
4. BUS SHELTERS LOCATED ON SIDEWALKS MUST BE CHOSEN AND LOCATED TO MAINTAIN A MINIMUM 4 FOOT CLEAR ACCESSIBLE PATH BETWEEN THE SHELTER, CROSSWALKS, AND BUS BOARDING AND ALIGHTING AREAS. BUS SHELTERS SHALL NOT BE PLACED ON CONSTRAINED BUS BULBS. THEY MUST BE PLACED ON THE SIDEWALKS, IF USED.
5. A MINIMUM 5-FOOT WIDE BY 8-FOOT DEEP BOARDING AND ALIGHTING AREA, WITH A MAXIMUM SLOPE OF 2% IN ANY DIRECTION, IS REQUIRED AT FORWARD LOADING AREA ADJACENT TO THE BUS DOOR. THE 8-FOOT DEPTH MAY INCLUDE THE ADJACENT CURBLINE, BUT IS EXCLUSIVE OF ANY RAILING OR BATTERED CURB SPACE; AS SUCH THE PHYSICAL WIDTH OF THE CONSTRUCTED BUS BULB MAY NEED TO EXCEED 8-FEET. A 4-FOOT MINIMUM CLEAR ACCESSIBLE ROUTE MUST BE PROVIDED BETWEEN THE BOARDING AND ALIGHTING AREA AND THE SIDEWALK. AN ACCESSIBLE ROUTE MUST ALSO BE PROVIDED BETWEEN ANY PROVIDED BUS SHELTERS AND THE BOARDING AND ALIGHTING AREA. IF A BUS BULB SERVES MULTIPLE TRANSIT VEHICLE STOPS SIMULTANEOUSLY, BOARDING AND ALIGHTING AREAS MUST BE PROVIDED AT EACH VEHICLE DOOR AND ACCESSIBLE ROUTES PROVIDED ACCORDINGLY.
6. THE MINIMUM BUS BULB LENGTH IS IDENTIFIED IN THE TABLE ON SHEET 3, BUT THE PREFERABLE LENGTH IS BASED ON THE LENGTH OF THE BUS(ES) EXPECTED TO USE THE BUS STOP. IF MULTIPLE BUSES ARE EXPECTED TO USE THE STOP AT THE SAME TIME, THE LENGTH SHOULD BE BASED ON THE BUS LENGTH(S) WITH 20-FEET OF SEPARATION BETWEEN THE BUSES. THE LENGTH OF A BUS BULB IS EXCLUSIVE OF ALL PEDESTRIAN RAMPS.
7. AT LOCATIONS WHERE THE SIDEWALK IS LESS THAN 5 FEET IN WIDTH, A CONSTRAINED BUS BULB SHOULD BE CONSIDERED.
8. A MINIMUM 12-FOOT X 4-FOOT CLEAR SPACE, WITH A MAXIMUM SLOPE OF 2% IN ANY DIRECTION IS RECOMMENDED AT ALL REAR BUS DOORS. IF THE REAR DOOR SERVES AS THE WHEELCHAIR ACCESSIBLE LOADING DOOR, A 5-FOOT X 8-FOOT LOADING AREA IS REQUIRED.
9. SEE TABLE ON SHEET 3 OF 4 FOR DASH AND METRO BUS DETAILS AND THE CORRESPONDING MINIMUM AND RECOMMENDED BUS BULB LENGTHS.
10. A MINIMUM OF 24 INCH SETBACK IS NEEDED FROM THE FACE OF CURB TO A BUS SHELTER CANOPY IF PROVIDED. A MINIMUM OF 18 INCH SETBACK IS RECOMMENDED FROM A BIKE LANE FACE OF CURB TO THE FACE OF ANY REAR SUPPORT POSTS. THE SELECTION OF BUS SHELTER TYPES AND BUS BULB WIDTHS MUST BE COORDINATED TO ENSURE CLEARANCES AND NECESSARY ACCESSIBLE ROUTES ARE PROVIDED.
11. BUS BULBS SHALL HAVE RED CURB ALONG THEIR ENTIRE LENGTH ADJACENT TO THE STREET. ADDITIONAL RED CURB PRIOR TO AND AFTER THE BUS BULB MAY BE REQUIRED BY LADOT.
12. A HANDRAIL IS REQUIRED IF DROP-OFF FROM THE BUS BULB TO THE ADJACENT BIKE LANE EXCEEDS 8 INCHES. A MINIMUM OF 10 INCH SETBACK IS NEEDED FROM A BIKE LANE FACE OF CURB TO THE FACE OF PEDESTRIAN HAND RAIL ON THE BUS BULB.

<p>CITY OF LOS ANGELES DEPARTMENT OF TRANSPORTATION</p>	<p>Title BUS BULBS</p>	<p>Drawing No. S-523.0</p>	<p>4 4</p>
---	----------------------------	--------------------------------	----------------

MINI-ROUNDBABOUTS

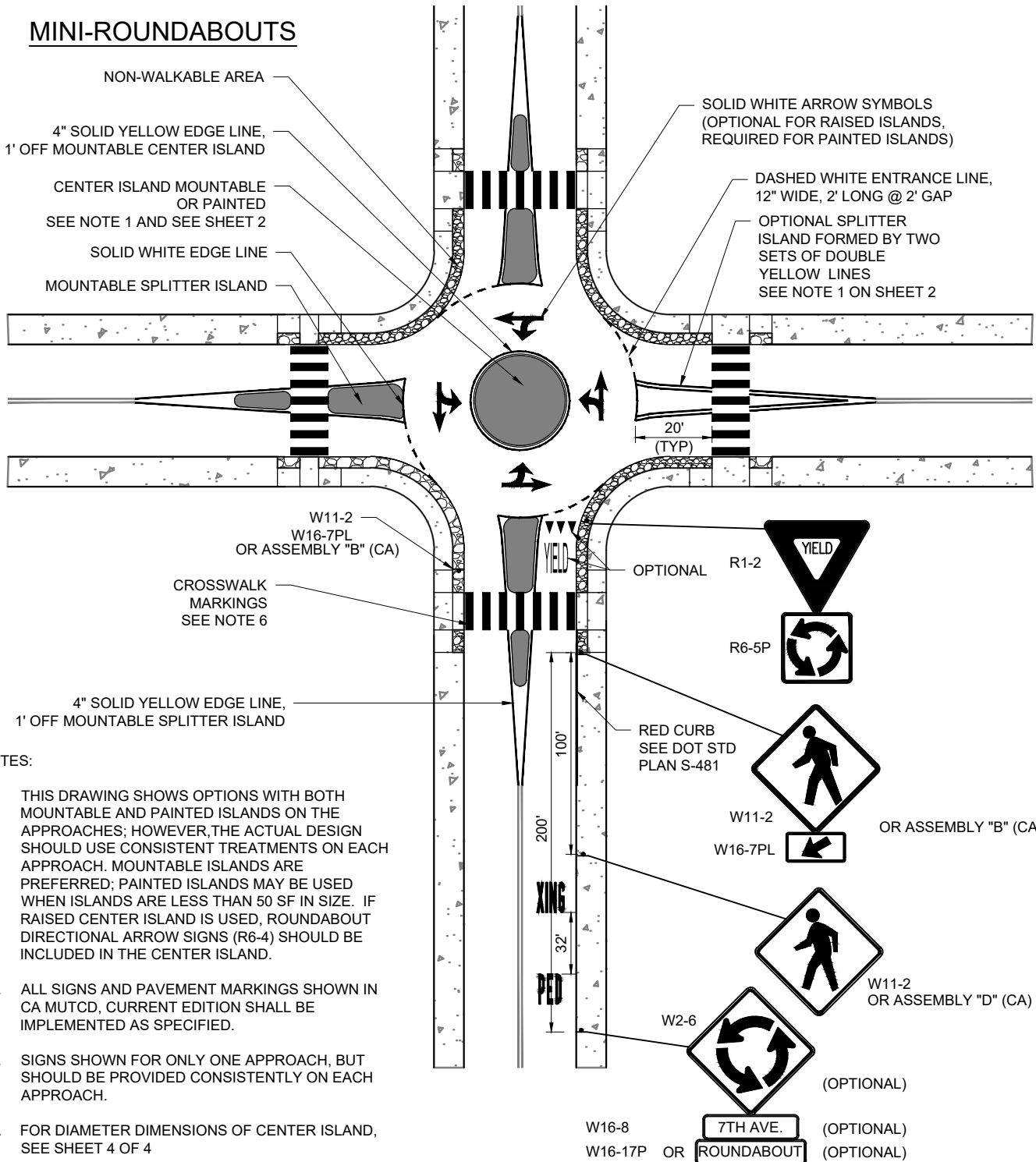

NOTES:

1. THIS DRAWING SHOWS OPTIONS WITH BOTH MOUNTABLE AND PAINTED ISLANDS ON THE APPROACHES; HOWEVER, THE ACTUAL DESIGN SHOULD USE CONSISTENT TREATMENTS ON EACH APPROACH. MOUNTABLE ISLANDS ARE PREFERRED; PAINTED ISLANDS MAY BE USED WHEN ISLANDS ARE LESS THAN 50 SF IN SIZE. IF RAISED CENTER ISLAND IS USED, ROUNDABOUT DIRECTIONAL ARROW SIGNS (R6-4) SHOULD BE INCLUDED IN THE CENTER ISLAND.
2. ALL SIGNS AND PAVEMENT MARKINGS SHOWN IN CA MUTCD, CURRENT EDITION SHALL BE IMPLEMENTED AS SPECIFIED.
3. SIGNS SHOWN FOR ONLY ONE APPROACH, BUT SHOULD BE PROVIDED CONSISTENTLY ON EACH APPROACH.
4. FOR DIAMETER DIMENSIONS OF CENTER ISLAND, SEE SHEET 4 OF 4
5. INSTALL NEW CURB RAMPS AND CROSSWALKS AS SHOWN. DIAGONAL RAMPS MAY NOT BE USED. EXISTING RAMPS WITHIN THE CIRCULATING LANE MUST BE REMOVED.
6. CROSSWALKS MAY BE SUPPLEMENTED WITH PEDESTRIAN ACTIVATED RECTANGULAR RAPID FLASHING BEACONS (RRFB'S).
7. SEE CITY OF LOS ANGELES SUPPLEMENTAL STREET DESIGN GUIDE DETAIL 710 FOR MINI-ROUNDABOUT DETAILS.

APPROVED	02-20-2020	
for Seleta Reynolds, General Manager		
CITY OF LOS ANGELES DEPARTMENT OF TRANSPORTATION		
MINI-ROUNDBABOUTS AND NEIGHBORHOOD TRAFFIC CIRCLES		
1	4	
CKD. Priv. Engr.	SR. T.E. JV	PR. T.E. BS
DWN. Piv. Engr.	T.E. MN	S-524.0

MINI-ROUNDBABOUTS

ISLAND DIMENSIONS WHEN PAINTED

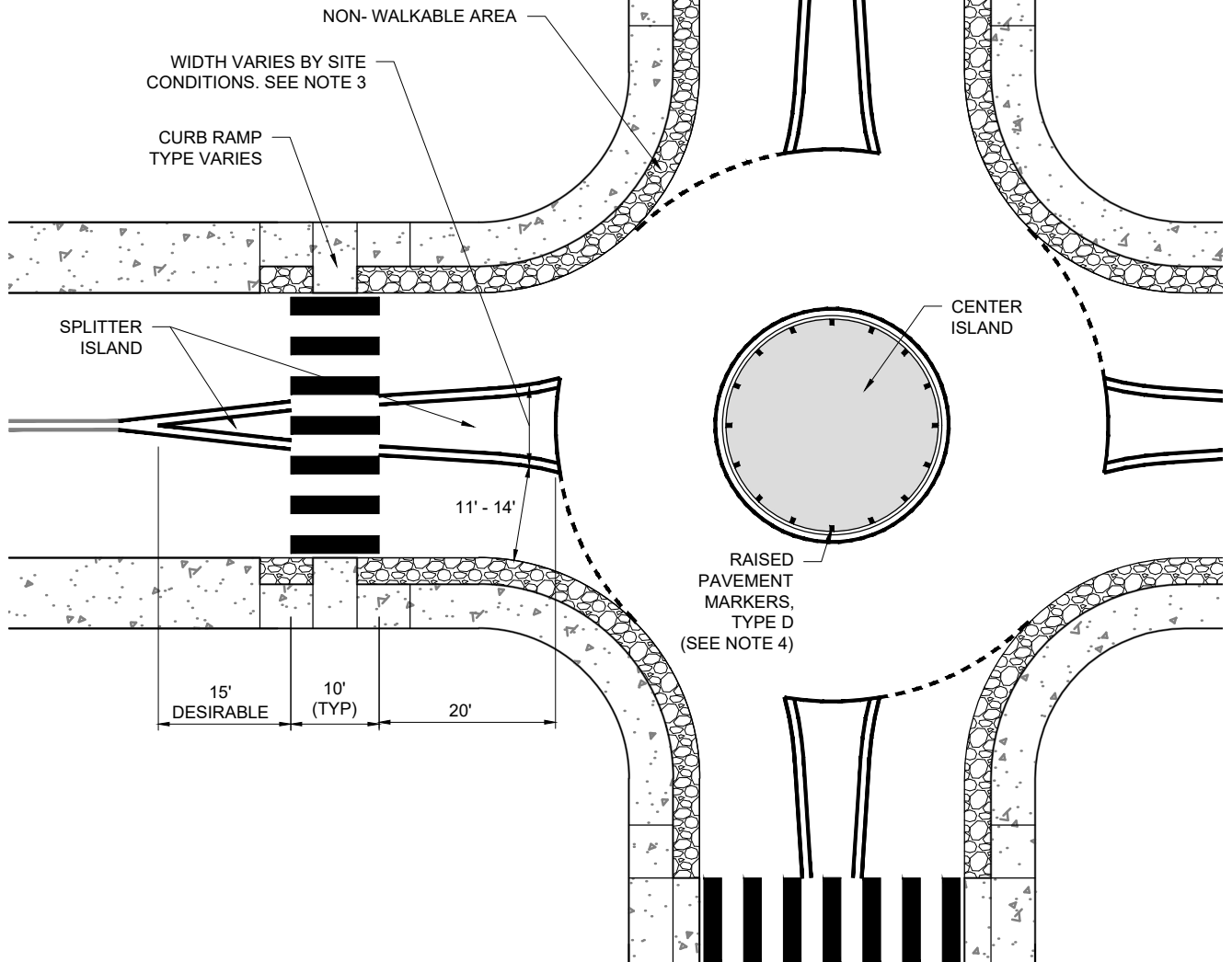

NOTES:

1. PAINTED SPLITTER ISLANDS MAY BE USED WHEN SITE GEOMETRY LEADS TO ISLANDS LESS THAN 50 SF IN SIZE.
2. USE DIMENSION SCHEDULE ON SHEET 4 OF 4 AS A DESIGN GUIDE. FINAL DIMENSIONS TO BE DETERMINED BY THE ENGINEER.
3. WHERE CROSSING STREETS ARE NOT THE SAME WIDTH, CONSIDER CURB EXTENSIONS ON WIDER ROAD TO CREATE CONSISTENT APPROACH WIDTHS.
4. TYPE D PAVEMENT MARKERS PLACED ON THE YELLOW CENTERLINE ARE REQUIRED FOR PAINTED CENTER ISLANDS AND SPLITTER ISLANDS AND RECOMMENDED FOR RAISED SPLITTER AND CENTER ISLANDS.
 USE 12 FOR $\leq 15'$ DIA.
 USE 16 FOR $> 15'$ DIA. $< 20'$ DIA.
 USE 20 FOR $\geq 20'$ DIA.

NEIGHBORHOOD TRAFFIC CIRCLES

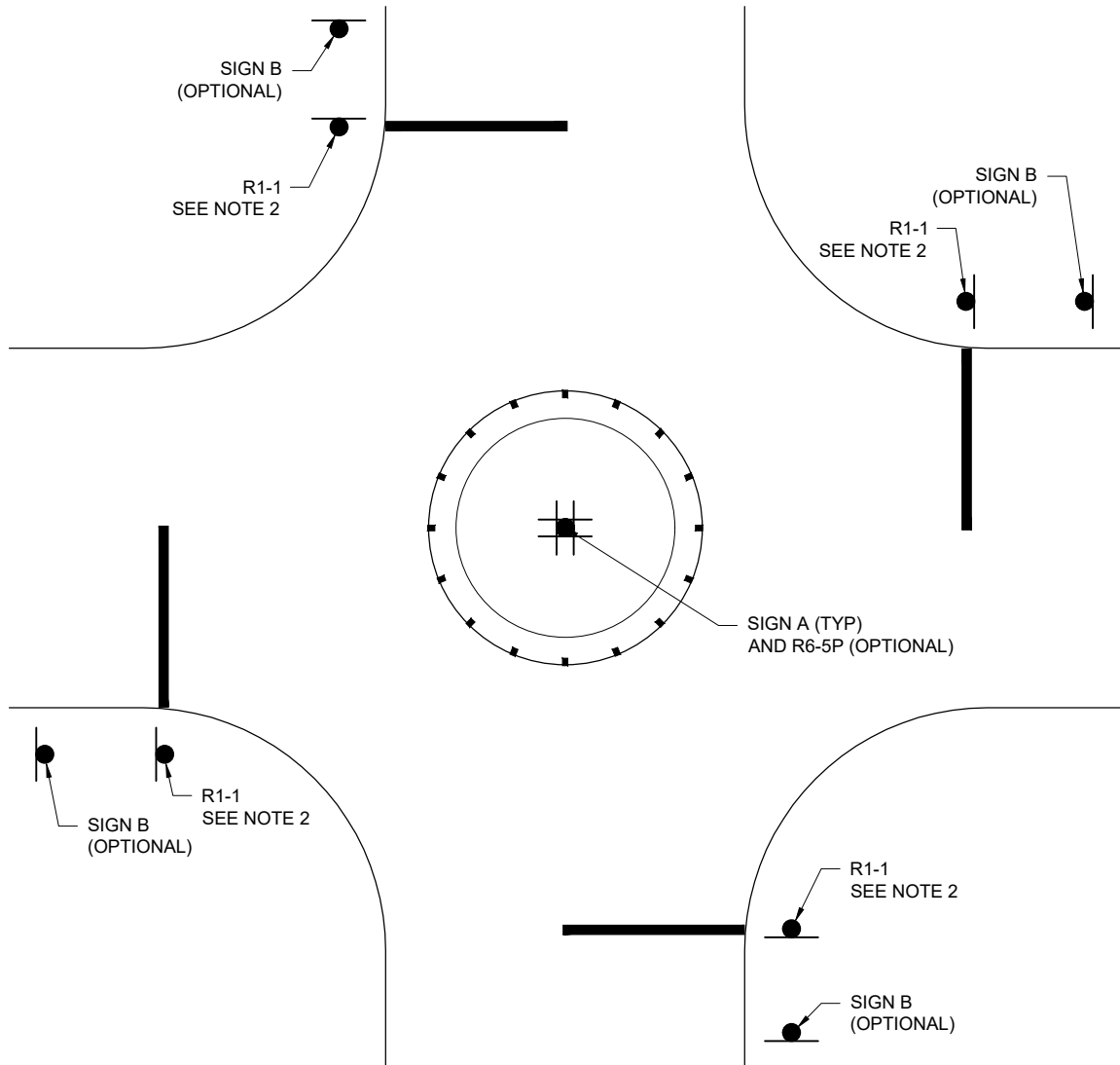

SIGN A

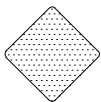

18" X 18" YELLOW HIGH INTENSITY TYPE 1 OBJECT MARKER PLACED IN TRAFFIC CIRCLE FOR EACH APPROACH. ALL SIGNS TO BE MOUNTED ON SINGLE POST. LOCATION TO BE DETERMINED BY ENGINEER. SIGN HEIGHT: 5' FROM BOTTOM OF LOWER SIGN TO BARK MULCH.

SIGN B



30" X 30" BLACK ON YELLOW PLACED 75' TO 100' BACK FROM TRAFFIC CIRCLE ON EACH APPROACH (OPTIONAL).

NOTES

1. SEE CITY OF LOS ANGELES SUPPLEMENTAL STREET DESIGN GUIDE, DETAIL 700 FOR NEIGHBORHOOD TRAFFIC CIRCLE DETAILS.
2. TWO-WAY STOP CONTROL IS OPTIONAL.
3. USE DIMENSION SCHEDULE AS SHOWN ON SHEET 4 OF 4 AS A DESIGN GUIDE. FINAL DIMENSIONS TO BE DETERMINED BY THE ENGINEER.

CENTER ISLAND GEOMETRY

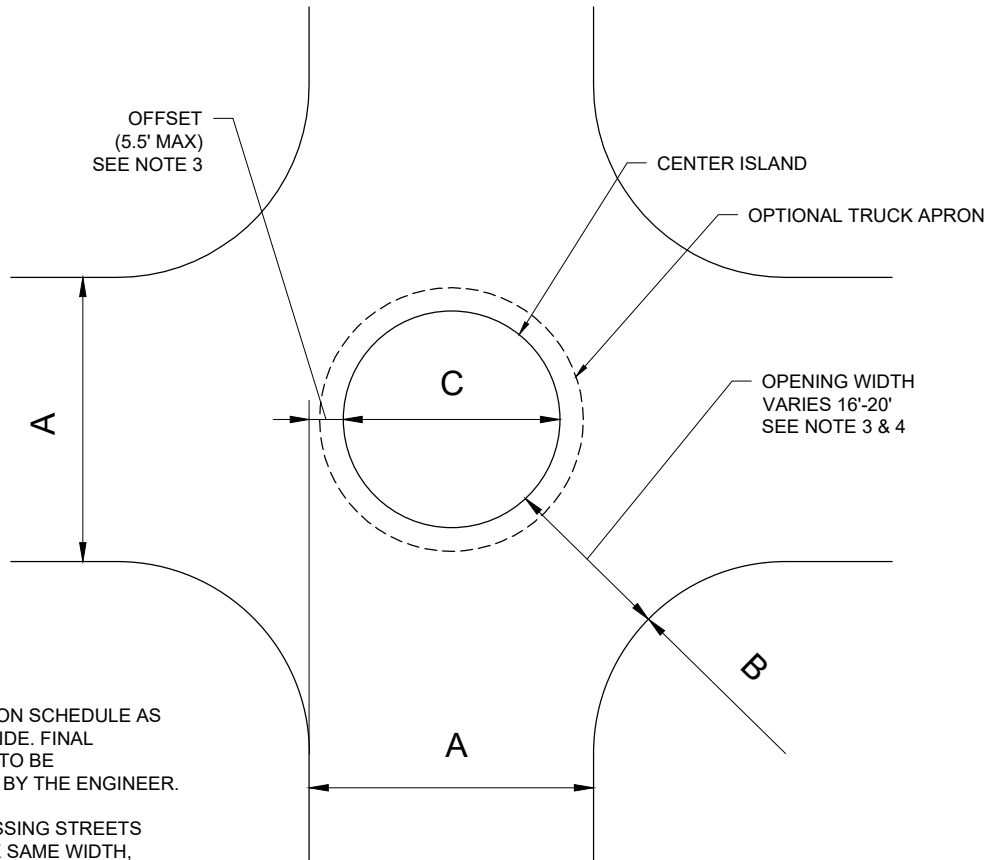

NOTES

1. USE DIMENSION SCHEDULE AS A DESIGN GUIDE. FINAL DIMENSIONS TO BE DETERMINED BY THE ENGINEER.
2. WHERE CROSSING STREETS ARE NOT THE SAME WIDTH, CONSIDER CURB EXTENSIONS ON WIDER ROAD TO CREATE CONSISTENT APPROACH WIDTHS.
3. FOR LOCATIONS WITH NON-STANDARD STREET WIDTHS, THE RELATIONSHIP BETWEEN THE OFFSET AND THE OPENING WIDTH IS DETERMINED BY THE OPENING WIDTH TABLE:
4. WHERE THE CIRCULATING WIDTH IS LESS THAN 20 FEET WIDE, A MOUNTABLE TRUCK APRON MAY BE REQUIRED.

DIMENSIONS

A STREET WIDTH	B CURB RETURN RADIUS	C CENTER ISLAND DIAMETER
28' (HILLSIDE LIMITED STANDARD)	15'	18'
	20'	20'
	25'	22'
30' (LOCAL STREET LIMITED)	15'	20'
	20'	22'
	25'	24'
36' (LOCAL STREET STANDARD)	15'	27'
	20'	29'
	25'	33'
40' (COLLECTOR)	15'	32'
	20'	34'
	25'	38'

OPENING WIDTH

OFFSET	OPENING WIDTH
5.5' (MAX)	16' (MIN)
5.0	17'
4.5	18'
4.0	19'
3.5 OR LESS	20' (MAX)

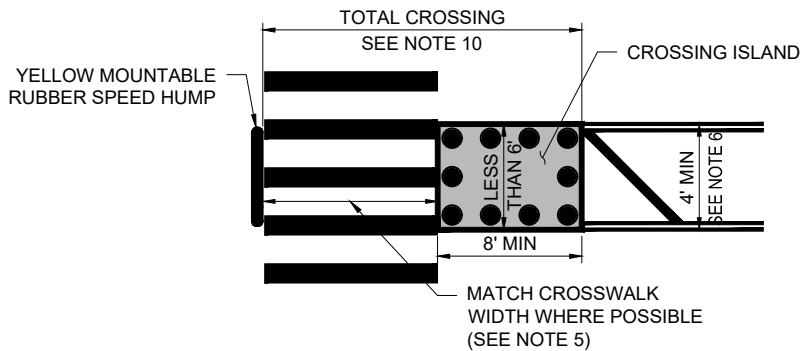
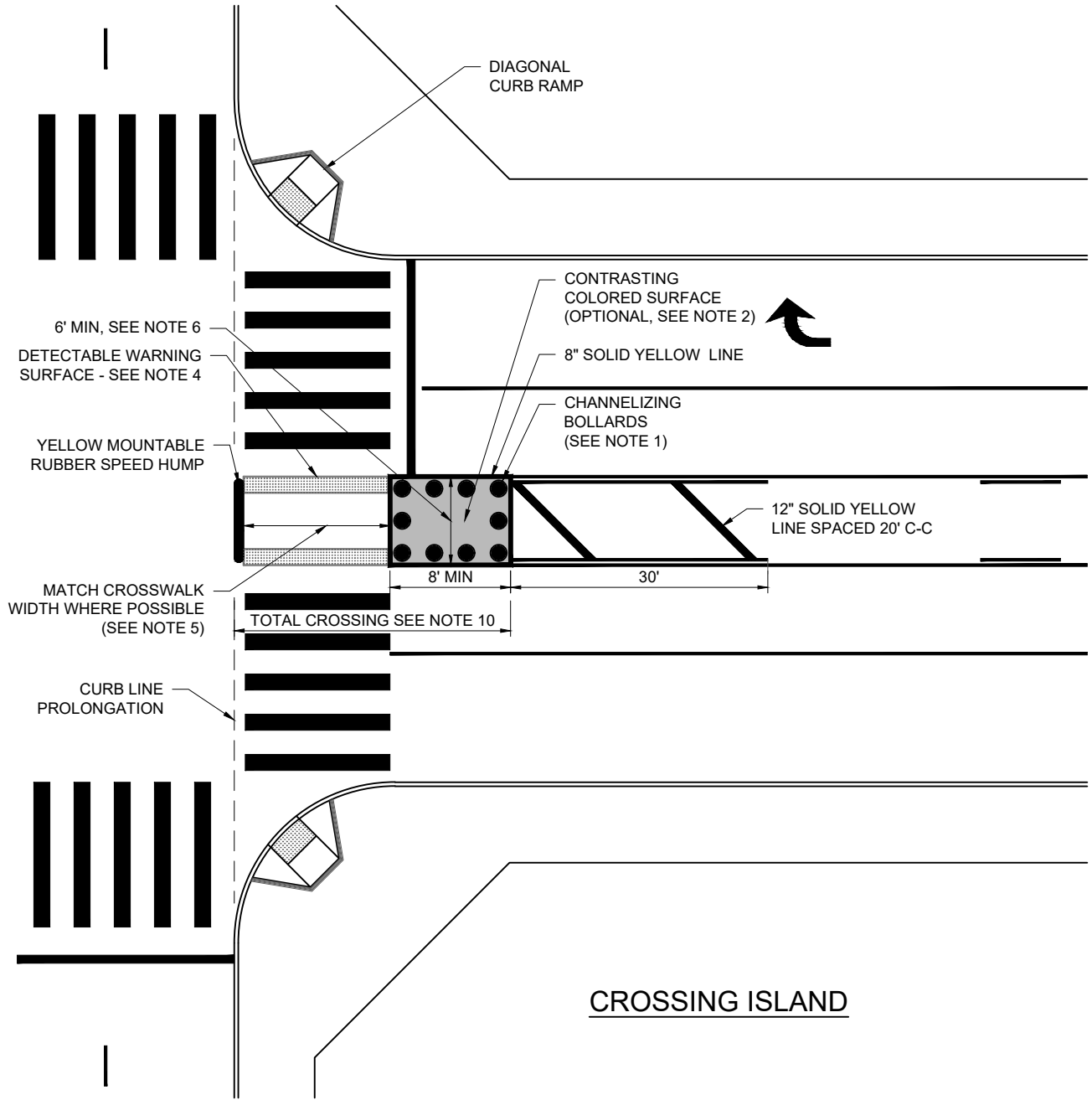

OPTION WHEN ISLAND IS LESS THAN 6' WIDE

APPROVED		02-20-2020
for Seleta Reynolds, General Manager		
CITY OF LOS ANGELES DEPARTMENT OF TRANSPORTATION		
CROSSING ISLANDS		1 5
CKD. Priv. Engr.	SR. T.E. JV	PR. T.E. BS
DWN. Priv. Engr.	T.E. MN	S-525.0

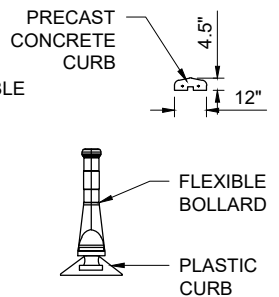
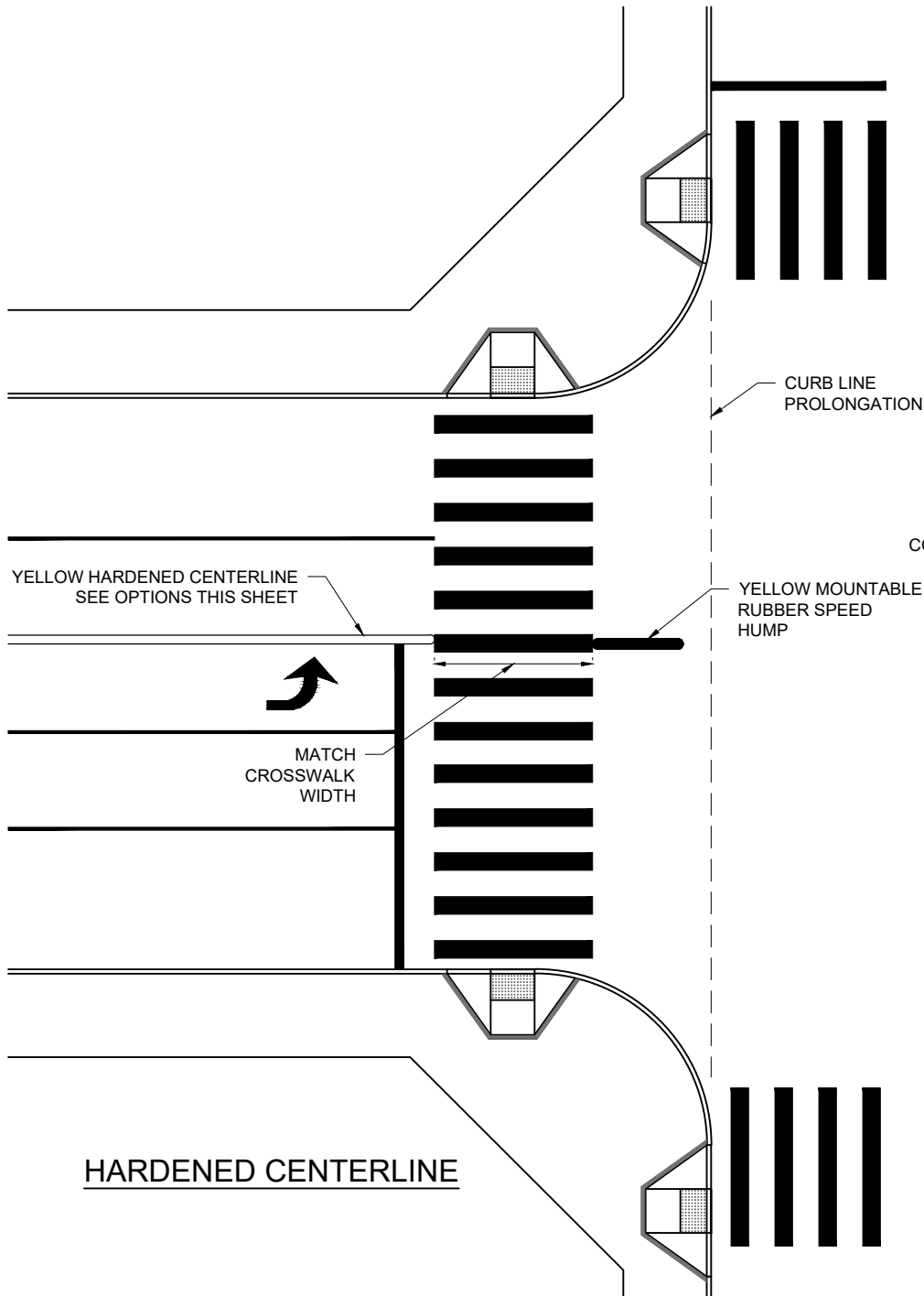

OPTIONS

DETECTABLE WARNING SURFACE - SEE NOTE 4

6' MIN, SEE NOTE 6

APPROACH NOSE - DESIGN FOR SITE CONDITIONS

R4-7, OM1-1 (TYP)

RPM (TYP), SEE NOTE 9

CURB LINE PROLONGATION

DIRECTIONAL CURB RAMPS

PEDESTRIAN PUSH BUTTON SEE NOTE 3

8' MIN

R4-7, OM1-1 (TYP)

4" SOLID YELLOW LINE 1' OFF CENTER MEDIAN

12" SOLID YELLOW LINE SPACED 20' C-C

18" MAX.

CROSSING ISLAND

MATCH CROSSWALK WIDTH WHERE POSSIBLE (SEE NOTE 5)

TOTAL CROSSING SEE NOTE 10

CASE A - DIRECTIONAL RAMPS

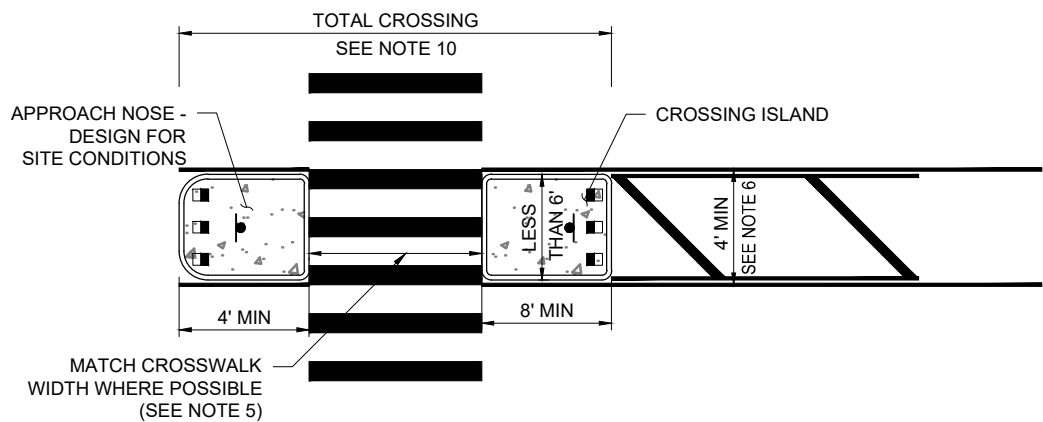

OPTION WHEN ISLAND IS LESS THAN 6' WIDE

SEE NOTE 3

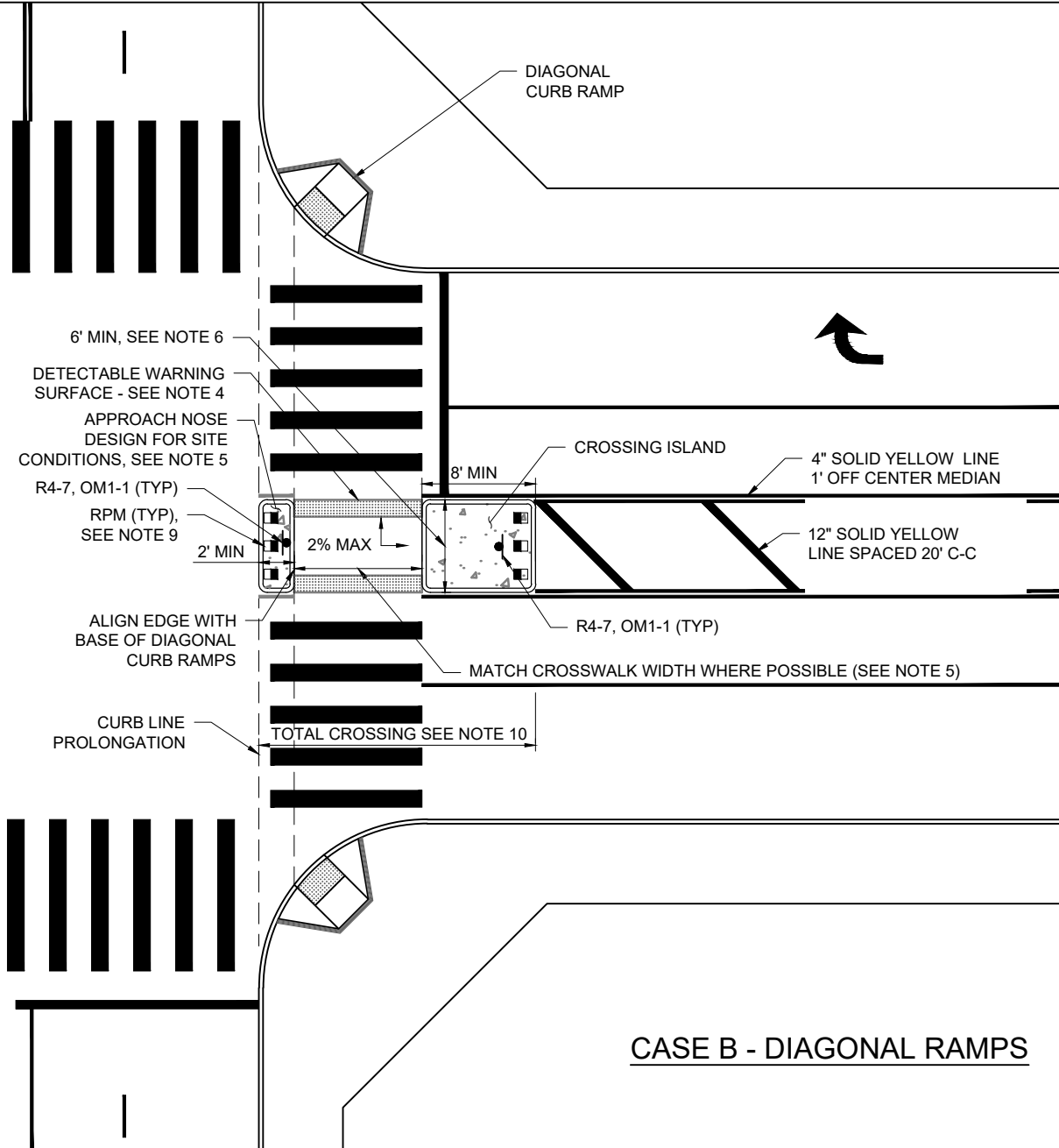

CASE B - DIAGONAL RAMPS

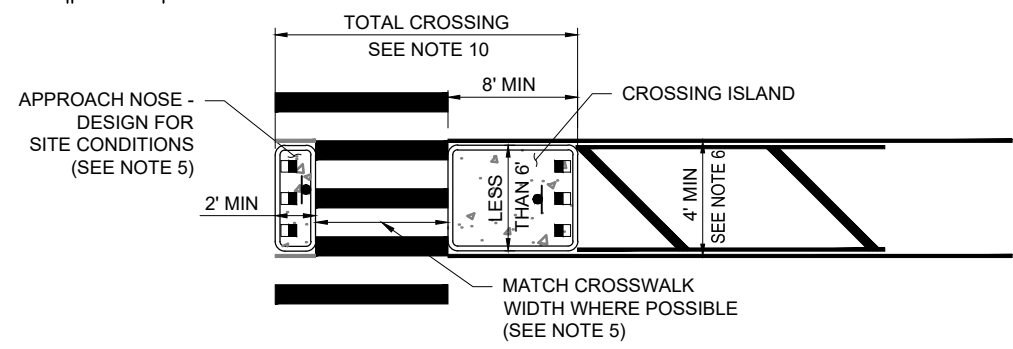

OPTION WHEN ISLAND IS LESS THAN 6' WIDE
SEE NOTE 3

NOTES

1. BOLLARDS SHALL BE LOCATED 6 INCHES BEHIND THE EDGE LINE. BOLLARDS MAY BE SPACED BETWEEN 24 INCHES AND 60 INCHES TO ENSURE A MINIMUM OF THREE BOLLARDS ARE PROVIDED. AN EVEN SPACING BETWEEN BOLLARDS SHOULD BE SELECTED. BOLLARDS SHOULD NOT BE LOCATED WITHIN A CROSSWALK OR PARKING LANE.
2. THE PAVEMENT SURFACE MAY BE COLORED TO ENHANCE THE CONTRAST BETWEEN THE ADJACENT TRAVELLED WAY AND THE CURB EXTENSION WITH MATERIALS APPROVED BY CITY.
3. AT SIGNALIZED INTERSECTIONS, IF THE CROSSING ISLAND IS AT LEAST 6 FEET WIDE, THEN A PEDESTRIAN PUSH BUTTON MAY BE PROVIDED WITHIN THE CROSSING ISLAND WITH LADOT APPROVAL. PUSH BUTTONS SHOULD BE LOCATED AT THE CENTER OF THE ISLAND, BUT WIDER ISLANDS MAY NECESSITATE TWO PUSH BUTTONS CLOSER TO THE EDGE OF THE ISLAND. PUSH BUTTONS SHOULD BE LOCATED WITHIN 18 INCHES FROM CURB FACE. IF CROSSING ISLANDS ARE LESS THAN 6 FEET WIDE, THEN PEDESTRIAN CROSSING SIGNALS MUST BE TIMED TO ALLOW COMPLETE CROSSING AND NO PUSH BUTTONS SHALL BE LOCATED IN THE CROSSING ISLAND.
4. DETECTABLE WARNING SURFACES SHALL BE USED IF CROSSING ISLAND SERVES AS A PEDESTRIAN REFUGE. DETECTABLE WARNING SHALL BE 36" DEEP WHEN THE CROSSING ISLAND IS 8' OR MORE IN WIDTH. BETWEEN 6' AND 8', THE DETECTABLE WARNING SHALL BE 24" DEEP. THE DETECTABLE WARNING SHALL BE PLACED AT THE EDGES OF THE PEDESTRIAN ISLAND OR CUT-THROUGH MEDIAN, AND SHALL BE SEPARATED BY 24" MINIMUM OF WALKING SURFACE WITHOUT DETECTABLE WARNINGS.
5. IF THE PEDESTRIAN MEDIAN OPENING IS GREATER THAN 20 FEET WIDE, THEN A BOLLARD MAY BE CONSIDERED TO PREVENT VEHICLES FROM ENCROACHING INTO THE PEDESTRIAN REFUGE SPACE. NARROWING THE PEDESTRIAN MEDIAN OPENING TO LESS THAN THE CROSSWALK WIDTH MAY BE CONSIDERED IN ORDER TO CREATE SUFFICIENT SPACE FOR AN APPROACH NOSE.
6. A MINIMUM OF 6 FOOT WIDTH IS REQUIRED TO PROVIDE PEDESTRIAN REFUGE. WIDTHS OF 8 TO 10 FEET ARE PREFERRED WHERE PEDESTRIAN VOLUMES ARE HIGH, WHERE PEOPLE WITH MOBILITY DEVICES CROSS, OR WHERE BICYCLISTS CROSS. THE MINIMUM WIDTH IS 4 FEET, BELOW WHICH A HARDENED CENTERLINE IS PREFERRED WHERE IT IS DESIRED TO SLOW LEFT-TURNING MOTORISTS.
7. WHEN DIAGONAL RAMPS ARE PRESENT, AN APPROACH NOSE MAY BE ADDED BY NARROWING THE CROSSING WIDTH (SEE NOTE 5). WHEN THIS IS NOT DESIRABLE, A RUBBERIZED MOUNTABLE APPROACH NOSE SHALL BE USED INSTEAD.
8. LANDSCAPING OF CROSSING ISLANDS SHALL FOLLOW SECTION E 467.3 OF THE BUREAU OF ENGINEERING STREET DESIGN MANUAL.
9. RAISED PAVEMENT MARKERS (RPM'S) ONE-WAY CLEAR (WHITE) OR ONE-WAY AMBER (YELLOW) SPACED 2' CENTER-TO-CENTER MAY BE INSTALLED ON THE CROSSING ISLAND DEPENDING ON ITS LOCATION.
10. THE TOTAL LENGTH OF THE CROSSING ISLANDS AND CROSSWALK SHALL BE LIMITED TO 30 FEET OR LESS ON STREETS WITH ONLY ONE THROUGH LANE IN EACH DIRECTION.
11. SEE CITY OF LOS ANGELES SUPPLEMENTAL STREET DESIGN GUIDE, DETAIL 500 FOR CROSSING ISLAND DETAILS.

<p>CITY OF LOS ANGELES DEPARTMENT OF TRANSPORTATION</p>	<p>Title CROSSING ISLANDS</p>	<p>Drawing No. S-525.0</p>	<p>5 5</p>
---	-----------------------------------	--------------------------------	----------------

MOUNTABLE TRUCK APRON

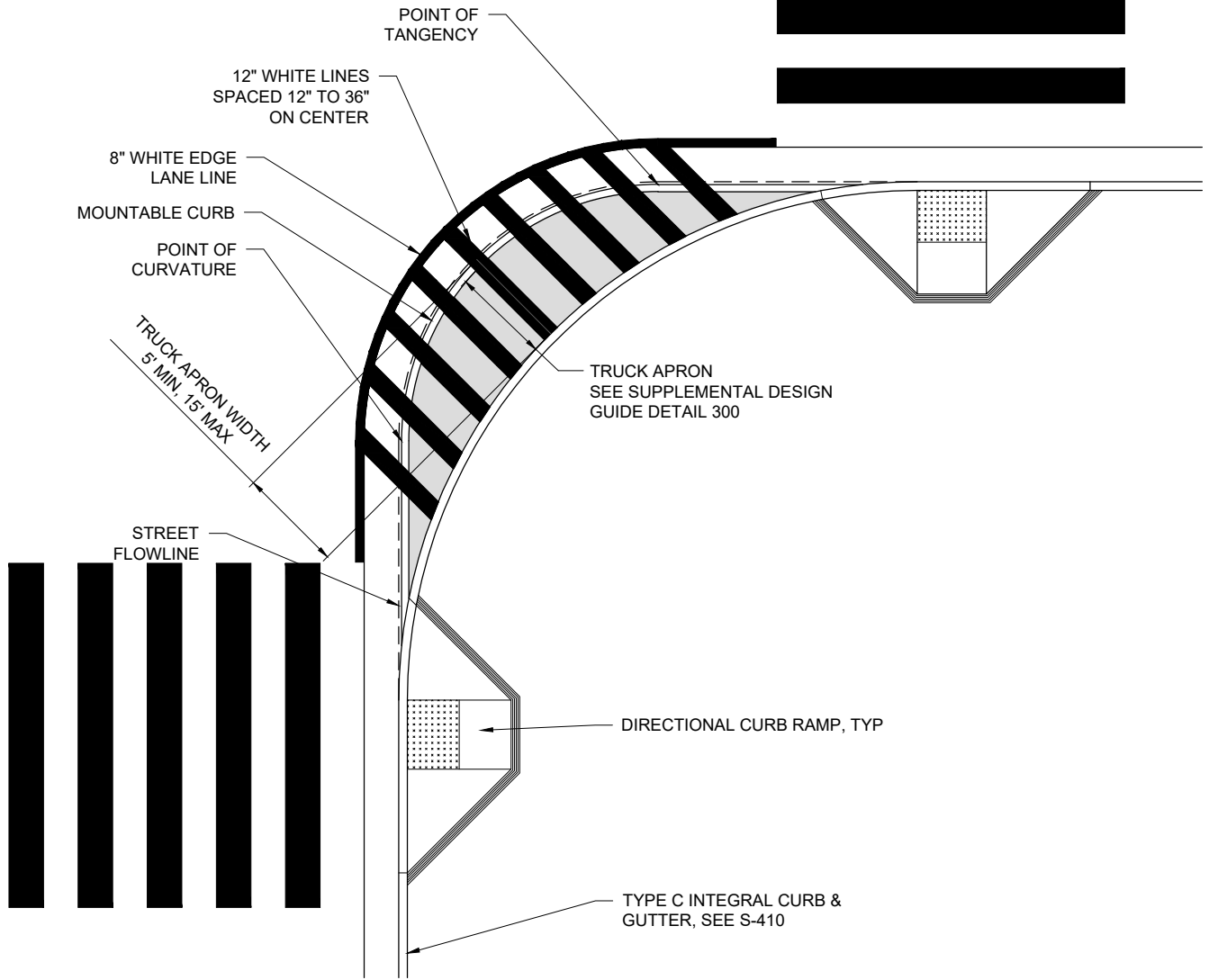

NOTE:

1. SEE CITY OF LOS ANGELES SUPPLEMENTAL STREET DESIGN GUIDE, DETAIL 300 FOR TRUCK APRON DETAILS.

APPROVED		02-20-2020
		
for Seleta Reynolds, General Manager		
CITY OF LOS ANGELES DEPARTMENT OF TRANSPORTATION		
TRUCK APRONS		1 1
CKD. Priv. Engr	SR. T.E. JV	PR. T.E. BS
DWN. Priv. Engr.	T.E. MN	S-526.0

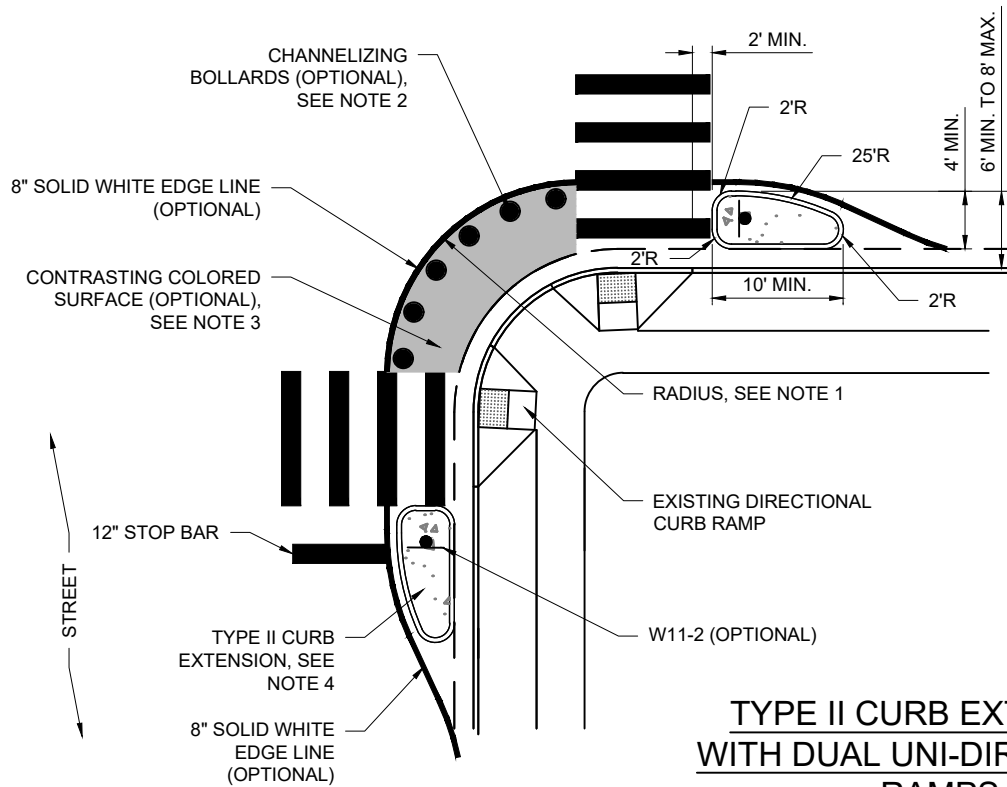

**TYPE II CURB EXTENSION
WITH DUAL UNI-DIRECTIONAL
RAMPS**

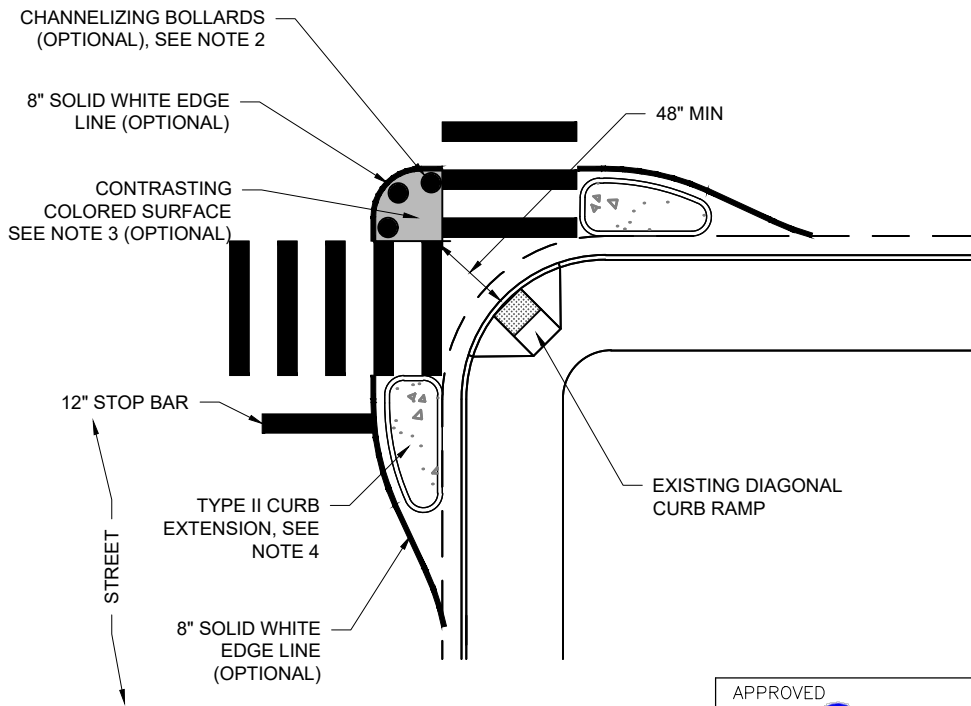

**TYPE II CURB EXTENSION
WITH DIAGONAL RAMP**

APPROVED		02-20-2020
for Seleta Reynolds, General Manager		
CITY OF LOS ANGELES DEPARTMENT OF TRANSPORTATION		
CURB EXTENSIONS		1 3
CKD. Priv. Engr.	SR. T.E. JV	PR. T.E. BS
DWN. Priv. Engr.	T.E. MN	S-527.0

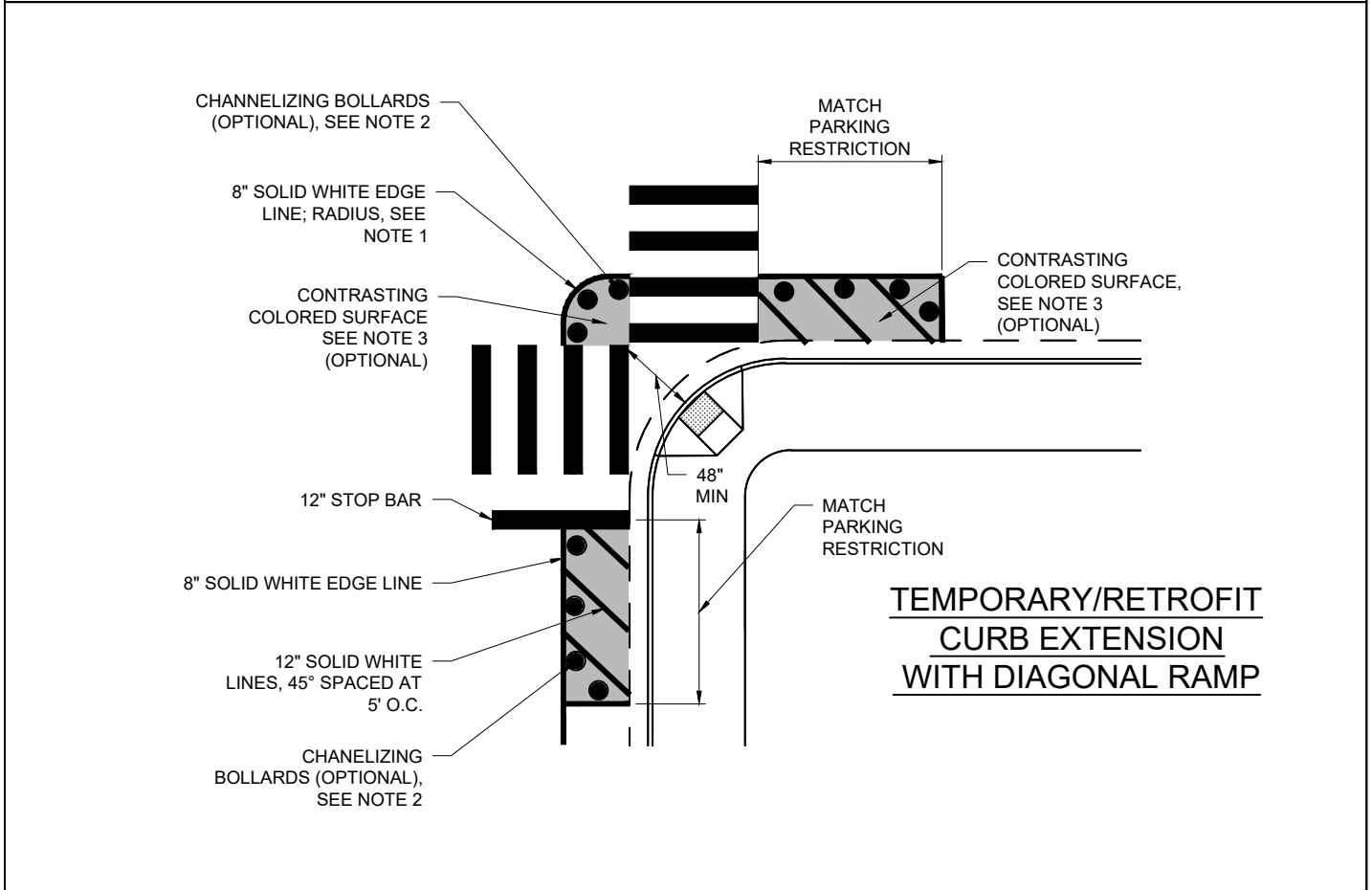
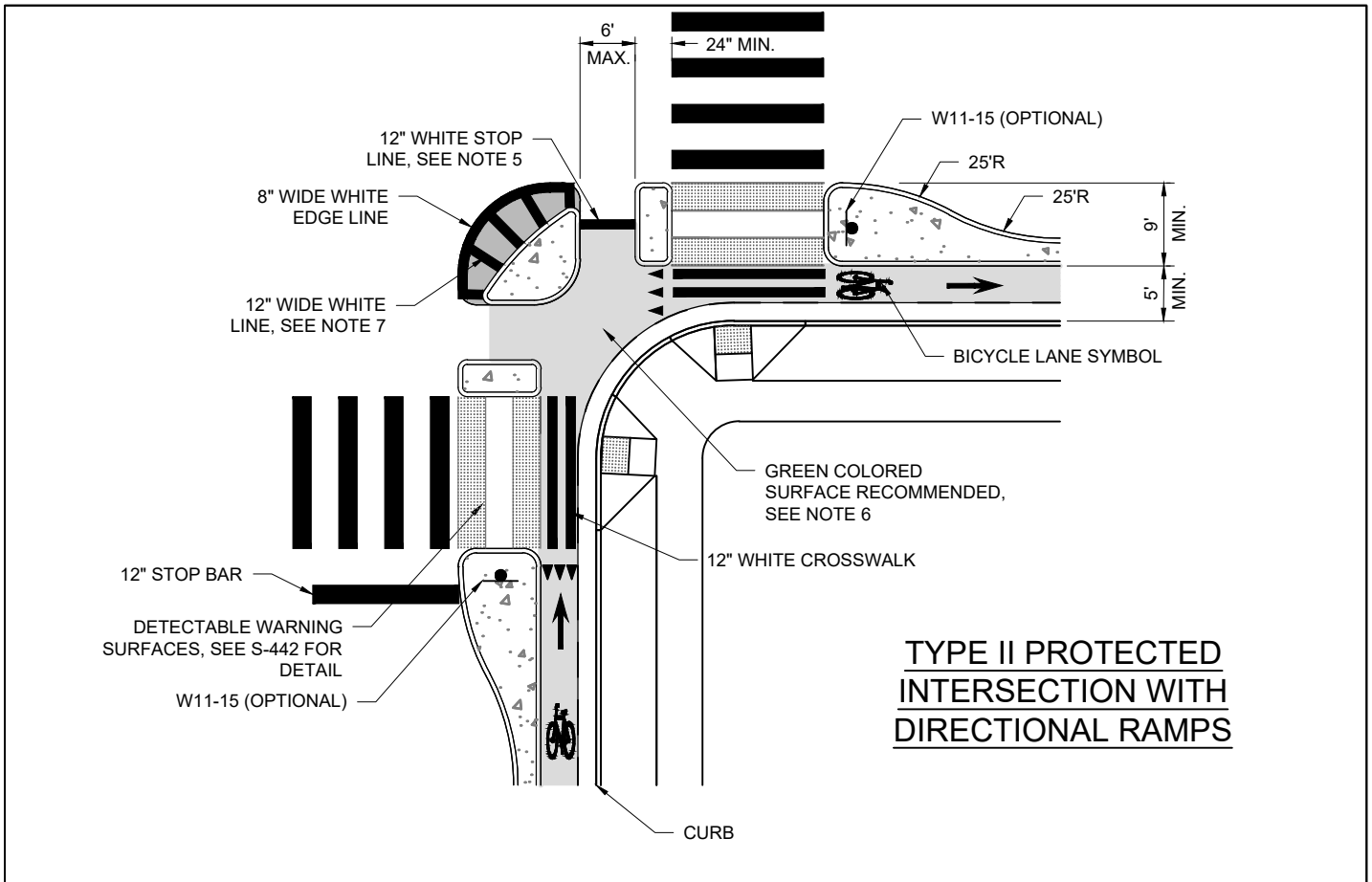

CITY OF LOS ANGELES DEPARTMENT OF TRANSPORTATION	Title CURB EXTENSIONS	Drawing No. S-527.0	2 3
---	--------------------------	------------------------	--------

NOTES

1. THE DESIGN RADIUS SHOULD BE ESTABLISHED FOLLOWING THE CITY'S CORNER RADIUS POLICY. OPTION TO IDENTIFY WITH A WHITE EDGE LINE.
2. WHERE BOLLARDS ARE PROVIDED, THE DESIGN RADIUS MUST ALLOW THE DESIGN VEHICLE TO TURN WITHOUT STRIKING THE BOLLARDS. THIS CAN BE ACCOMPLISHED BY MARKING THE CORNER RADIUS WITH A WHITE EDGE LINE AND LOCATING THE BOLLARDS SIX INCHES BEHIND THE EDGE LINE. BOLLARDS MAY BE SPACED BETWEEN 24 INCHES AND 60 INCHES TO ENSURE A MINIMUM OF THREE BOLLARDS ARE PROVIDED. AN EVEN SPACING BETWEEN BOLLARDS SHOULD BE SELECTED. BOLLARDS SHOULD NOT BE LOCATED WITHIN A CROSSWALK OR PARKING LANE.
3. THE PAVEMENT SURFACE MAY BE COLORED TO ENHANCE THE CONTRAST BETWEEN THE ADJACENT TRAVELED WAY AND THE CURB EXTENSION WITH MATERIALS APPROVAL BY THE CITY.
4. SEE CITY OF LOS ANGELES SUPPLEMENTAL STREET DESIGN GUIDE, DETAIL 200 FOR CURB EXTENSION DETAILS.
5. WHERE STOP LINE IS REQUIRED, IT SHOULD BE PLACED NEAR THE EDGE OF THE CROSSING ROADWAY, LOCATED OUTSIDE THE PATH OF TURNING VEHICLES.
6. OPTIONAL USE OF GREEN COLORED PAVEMENT TO ENHANCE VISIBILITY AND CONSPICUITY OF BICYCLE LANE. GREEN COLORED PAVEMENT MAY BE INSTALLED FOR THE ENTIRE LENGTH OF THE BICYCLE LANE OR FOR ONLY A PORTION (OR PORTIONS) OF THE BICYCLE LANE. ALL GREEN COLORED PAVEMENT SHOULD COMPLY WITH FHWA INTERIM APPROVAL FOR OPTIONAL USE OF GREEN COLORED PAVEMENT FOR BIKE LANES (IA-14) AND APPROVED BY LADOT.
7. OPTIONAL 12" WIDE WHITE LINES, PERPENDICULAR TO WHITE EDGE LINE. IF USED, MINIMUM OF THREE (3) LINES IS PREFERRED.

CITY OF LOS ANGELES DEPARTMENT OF TRANSPORTATION	Title CURB EXTENSIONS	Drawing No. S-527.0	3 3
---	--------------------------	------------------------	--------